

FEATURES

44 V supply maximum rating
 V_{SS} to V_{DD} analog signal range
Single-/dual-supply specifications
Wide supply range: 10.8 V to 16.5 V
Extended plastic temperature range: -40°C to $+85^{\circ}\text{C}$
Low power dissipation: 28 mW maximum
Low leakage: 20 pA typical
Available in 16-lead DIP/SOIC and 20-lead PLCC/LCC packages
Superior alternative to
DG508A, HI-508
DG509A, HI-509

FUNCTIONAL BLOCK DIAGRAMS

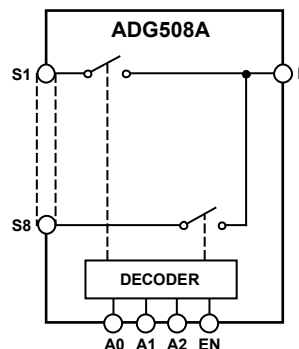

Figure 1. ADG508A

00051-001

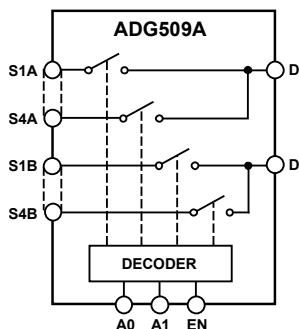

Figure 2. ADG509A

00051-002

GENERAL DESCRIPTION

The ADG508A and ADG509A are CMOS monolithic analog multiplexers with eight channels and dual four channels, respectively. The ADG508A switches one of eight inputs to a common output, depending on the state of three binary addresses and an enable input. The ADG509A switches one of four differential inputs to a common differential output, depending on the state of two binary addresses and an enable input. Both devices have TTL and 5 V CMOS logic-compatible digital inputs.

The ADG508A and ADG509A are designed on an enhanced LC²MOS process that gives an increased signal capability of V_{SS} to V_{DD} and enables operation over a wide range of supply voltages. The devices can comfortably operate anywhere in the 10.8 V to 16.5 V single- or dual-supply range. These multiplexers also feature high switching speeds and low R_{ON} .

PRODUCT HIGHLIGHTS

1. Single-/Dual-Supply Specifications with a Wide Tolerance. The devices are specified in the 10.8 V to 16.5 V range for both single and dual supplies.
2. Extended Signal Range. The enhanced LC²MOS processing results in a high breakdown and an increased analog signal range of V_{SS} to V_{DD} .
3. Break-Before-Make Switching. Switches are guaranteed break-before-make so that input signals are protected against momentary shorting.
4. Low Leakage. Leakage currents in the range of 20 pA make these multiplexers suitable for high precision circuits.

Rev. D

Information furnished by Analog Devices is believed to be accurate and reliable. However, no responsibility is assumed by Analog Devices for its use, nor for any infringements of patents or other rights of third parties that may result from its use. Specifications subject to change without notice. No license is granted by implication or otherwise under any patent or patent rights of Analog Devices. Trademarks and registered trademarks are the property of their respective owners.

TABLE OF CONTENTS

Features	1	Absolute Maximum Ratings	7
Functional Block Diagrams.....	1	ESD Caution.....	7
General Description	1	Pin Configurations and Function Descriptions	8
Product Highlights	1	Typical Performance Characteristics	10
Revision History	2	Test Circuits.....	11
Specifications.....	3	Single-Supply Octal DAC Application	13
Dual Supply	3	Outline Dimensions	14
Single Supply	5	Ordering Guide	16

REVISION HISTORY

7/09—Rev. C to Rev. D

Changes to Table 4.....	8
-------------------------	---

3/07—Rev. B to Rev. C

Updated Format.....	Universal
Changes to Table 3.....	6
Inserted Table 4.....	7
Inserted Table 6.....	8
Changes to Figure 24.....	12
Updated Outline Dimensions	13
Changes to Ordering Guide	15

SPECIFICATIONS

DUAL SUPPLY

$V_{DD} = 10.8\text{ V to }16.5\text{ V}$, $V_{SS} = -10.8\text{ V to }-16.5\text{ V}$, unless otherwise noted.

Table 1.

Parameter	ADG508A/ ADG509A K Version		ADG508A/ ADG509A B Version		ADG508A/ ADG509A T Version		Unit	Comments
	+25°C	-40°C to +85°	+25°C	-40°C to +85°C	+25°C	-55°C to +125°C		
ANALOG SWITCH								
Analog Signal Range	V_{SS} V_{DD}	V_{SS} V_{DD}	V_{SS} V_{DD}	V_{SS} V_{DD}	V_{SS} V_{DD}	V_{SS} V_{DD}	V min V max	
R_{ON}	280		280		280		Ω typ	$-10\text{ V} \leq V_S \leq +10\text{ V}$, $I_{DS} = 1\text{ mA}$; see Figure 14
	450	600	450	600	450	600	Ω max	
	300	400	300	400			Ω max	
					300	400	Ω max	$V_{DD} = 15\text{ V} (\pm 10\%)$, $V_{SS} = -15\text{ V} (\pm 10\%)$
R_{ON} Drift	0.6		0.6		0.6		%/°C typ	$V_S = 0$, $I_{DS} = 1\text{ mA}$
R_{ON} Match	5		5		5		% typ	$-10\text{ V} \leq V_S \leq +10\text{ V}$, $I_{DS} = 1\text{ mA}$
I_S (Off), Off Input Leakage	0.02		0.02		0.02		nA typ	$V_1 = \pm 10\text{ V}$, $V_2 = \mp 10\text{ V}$; see Figure 15
I_D (Off), Off Output Leakage	1	50	1	50	1	50	nA max	$V_1 = \pm 10\text{ V}$, $V_2 = \mp 10\text{ V}$; see Figure 16
	0.04		0.04		0.04		nA typ	
ADG508A	1	100	1	100	1	100	nA max	$V_1 = V_2 = \pm 10\text{ V}$; see Figure 17
ADG509A	1	50	1	50	1	50	nA max	
I_D (On), On Channel Leakage	0.04		0.04		0.04		nA typ	
ADG508A	1	100	1	100	1	100	nA max	$V_1 = \pm 10\text{ V}$, $V_2 = \mp 10\text{ V}$; see Figure 18
ADG509A	1	50	1	50	1	50	nA max	
I_{DIFF} , Differential Off Output Leakage (ADG509A Only)		25		25		25	nA max	
DIGITAL CONTROL								
V_{INH} , Input High Voltage		2.4		2.4		2.4	V min	$V_{IN} = 0\text{ to }V_{DD}$
V_{INL} , Input Low Voltage		0.8		0.8		0.8	V max	
I_{INL} or I_{INH}		1		1		1	μA max	
C_{IN} Digital Input Capacitance	8		8		8		pF max	
DYNAMIC CHARACTERISTICS								
$t_{TRANSITION}^1$	200		200		200		ns typ	$V_1 = \pm 10\text{ V}$, $V_2 = \mp 10\text{ V}$; see Figure 19
t_{OPEN}^1	300	400	300	400	300	400	ns max	See Figure 20
	50		50		50		ns typ	
t_{ON} (EN) ¹	25	10	25	10	25	10	ns min	See Figure 21
	200		200		200		ns typ	
t_{OFF} (EN) ¹	300	400	300	400	300	400	ns max	See Figure 21
	200		200		200		ns typ	
Off Isolation	300	400	300	400	300	400	ns max	$V_{EN} = 0.8\text{ V}$, $R_L = 1\text{ k}\Omega$, $C_L = 15\text{ pF}$, $V_S = 7\text{ V rms}$, $f = 100\text{ kHz}$
	68		68		68		dB typ	
	50		50		50		dB min	

ADG508A/ADG509A

Parameter	ADG508A/ ADG509A K Version		ADG508A/ ADG509A B Version		ADG508A/ ADG509A T Version		Unit	Comments
	+25°C	-40°C to +85°	+25°C	-40°C to +85°C	+25°C	-55°C to +125°C		
C _S (Off)	5		5		5		pF typ	V _{EN} = 0.8 V
C _D (Off)								
ADG508A	22		22		22		pF typ	V _{EN} = 0.8 V
ADG509A	11		11		11		pF typ	
Q _{INJ} , Charge Injection	4		4		4		pC typ	R _S = 0 Ω, V _S = 0; see Figure 22
POWER SUPPLY								
I _{DD}	0.6		0.6		0.6		mA typ	V _{IN} = V _{INL} or V _{INH}
		1.5		1.5		1.5	mA max	
I _{SS}	20		20		20		μA typ	V _{IN} = V _{INL} or V _{INH}
		0.2		0.2		0.2	mA max	
Power Dissipation	10		10		10		mW typ	
		28		28		28	mW max	

¹ Sample tested at 25°C to ensure compliance.

SINGLE SUPPLY

$V_{DD} = 10.8\text{ V to }16.5\text{ V}$, $V_{SS} = \text{GND} = 0\text{ V}$, unless otherwise noted.

Table 2.

Parameter	ADG508A/ ADG509A K Version		ADG508A/ ADG509A B Version		ADG508A/ ADG509A T Version		Unit	Comments
	+25°C	-40°C to +85°C	+25°C	-40°C to +85°C	+25°C	-55°C to +125°C		
ANALOG SWITCH								
Analog Signal Range	GND	GND	GND	GND	GND	GND	V min	
	V_{DD}	V_{DD}	V_{DD}	V_{DD}	V_{DD}	V_{DD}	V max	
R_{ON}	500		500		500		Ω typ	$GND \leq V_S \leq 10\text{ V}$, $I_{DS} = 0.5\text{ mA}$; see Figure 14
R_{ON} Drift	700	1000	700	1000	700	1000	Ω max	
R_{ON} Match	0.6		0.6		0.6		%/°C typ	$V_S = 0$, $I_{DS} = 0.5\text{ mA}$
I_S (Off), Off Input Leakage	5		5		5		% typ	$GND \leq V_S \leq 10\text{ V}$, $I_{DS} = 0.5\text{ mA}$
	0.02		0.02		0.02		nA typ	$V_1 = 10\text{ V/GND}$, $V_2 = \text{GND}/10\text{ V}$; see Figure 15
I_D (Off), Off Output Leakage	1	50	1	50	1	50	nA max	
	0.04		0.04		0.04		nA typ	$V_1 = 10\text{ V/GND}$, $V_2 = \text{GND}/10\text{ V}$; see Figure 16
ADG508A	1	100	1	100	1	100	nA max	
ADG509A	1	50	1	50	1	50	nA max	
I_D (On), On Channel Leakage	0.04		0.04		0.04		nA typ	$V_1 = V_2 = 10\text{ V/GND}$; see Figure 17
ADG508A	1	100	1	100	1	100	nA max	
ADG509A	1	50	1	50	1	50	nA max	
I_{DIFF} , Differential Off Output Leakage (ADG509A Only)		25		25		25	nA max	$V_1 = 10\text{ V/GND}$, $V_2 = \text{GND}/10\text{ V}$; see Figure 18
DIGITAL CONTROL								
V_{INH} , Input High Voltage		2.4		2.4		2.4	V min	
V_{INL} , Input Low Voltage		0.8		0.8		0.8	V max	
I_{INL} or I_{INH}		1		1		1	μA max	$V_{IN} = 0$ to V_{DD}
C_{IN} Digital Input Capacitance	8		8		8		pF max	
DYNAMIC CHARACTERISTICS								
$t_{TRANSITION}^1$	300		300		300		ns typ	$V_1 = 10\text{ V/GND}$, $V_2 = \text{GND}/10\text{ V}$; see Figure 19
	450	600	450	600	450	600	ns max	
t_{OPEN}^1	50		50		50		ns typ	See Figure 20
	25	10	25	10	25	10	ns min	
$t_{ON}(\text{EN})^1$	250		250		250		ns typ	See Figure 21
	450	600	450	600	450	600	ns max	
$t_{OFF}(\text{EN})^1$	250		250		250		ns typ	See Figure 21
	450	600	450	600	450	600	ns max	
Off Isolation	68		68		68		dB typ	$V_{EN} = 0.8\text{ V}$, $R_L = 1\text{ k}\Omega$, $C_L = 15\text{ pF}$, $V_S = 3.5\text{ V rms}$, $f = 100\text{ kHz}$
	50		50		50		dB min	
C_S (Off)	5		5		5		pF typ	$V_{EN} = 0.8\text{ V}$
C_D (Off)								
ADG508A	22		22		22		pF typ	$V_{EN} = 0.8\text{ V}$
ADG509A	11		11		11		pF typ	
Q_{INJ} , Charge Injection	4		4		4		pC typ	$R_S = 0\text{ }\Omega$, $V_S = 0\text{ V}$; see Figure 22

ADG508A/ADG509A

Parameter	ADG508A/ ADG509A K Version		ADG508A/ ADG509A B Version		ADG508A/ ADG509A T Version		Unit	Comments
	+25°C	-40°C to +85°C	+25°C	-40°C to +85°C	+25°C	-55°C to +125°C		
POWER SUPPLY								
I_{DD}	0.6		0.6		0.6		mA typ	$V_{IN} = V_{INL}$ or V_{INH}
		1.5		1.5		1.5	mA max	
Power Dissipation	10		10		10		mW typ	
		25		25		25	mW max	

¹ Sample tested at 25°C to ensure compliance.

ABSOLUTE MAXIMUM RATINGS

$T_A = 25^\circ\text{C}$, unless otherwise noted.

Table 3.

Parameter	Ratings
V_{DD} to V_{SS}	44 V
V_{DD} to GND	32 V
V_{SS} to GND	-32 V
Analog Inputs ¹ Voltage at S, D	$V_{SS} - 2\text{ V}$ to $V_{DD} + 2\text{ V}$ or 20 mA, whichever occurs first
Continuous Current, S or D	20 mA
Pulsed Current S or D 1 ms Duration, 10% Duty Cycle	40 mA
Digital Inputs ¹ Voltage at A, EN	$V_{SS} - 4\text{ V}$ to $V_{DD} + 4\text{ V}$ or 20 mA, whichever occurs first
Power Dissipation (Any Package) Up to 75°C Derates Above 75°C by	470 mW 6 mW/ $^\circ\text{C}$
Operating Temperature Commercial (K Version)	-40°C to $+85^\circ\text{C}$
Industrial (B Version)	-40°C to $+85^\circ\text{C}$
Extended (T Version)	-55°C to $+125^\circ\text{C}$
Storage Temperature Range	-65°C to $+150^\circ\text{C}$

¹Overvoltage at A, EN, S, or D is clamped by diodes. Current should be limited to the maximum rating shown in Table 3.

Stresses above those listed under Absolute Maximum Ratings may cause permanent damage to the device. This is a stress rating only; functional operation of the device at these or any other conditions above those indicated in the operational section of this specification is not implied. Exposure to absolute maximum rating conditions for extended periods may affect device reliability.

ESD CAUTION



ESD (electrostatic discharge) sensitive device. Charged devices and circuit boards can discharge without detection. Although this product features patented or proprietary protection circuitry, damage may occur on devices subjected to high energy ESD. Therefore, proper ESD precautions should be taken to avoid performance degradation or loss of functionality.

ADG508A/ADG509A

PIN CONFIGURATIONS AND FUNCTION DESCRIPTIONS



Figure 3. ADG508A DIP, SOIC



Figure 4. ADG508A LCC

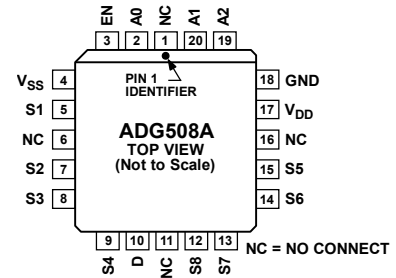

Figure 5. ADG508A PLCC

Table 4. ADG508A Pin Function Description

Pin Number		Mnemonic	Description
DIP/SOIC	PLCC/LCC		
1	2	A0	Logic Control Input.
2	3	EN	Active High Digital Input. When low, the device is disabled and all switches are off. When high, Ax logic inputs determine on switches.
3	4	V _{SS}	Most Negative Power Supply Potential in Dual Supplies. In single-supply applications, it can be connected to ground.
4	5	S1	Source Terminal 1. Can be an input or an output.
5	7	S2	Source Terminal 2. Can be an input or an output.
6	8	S3	Source Terminal 3. Can be an input or an output.
7	9	S4	Source Terminal 4. Can be an input or an output.
8	10	D	Drain Terminal. Can be an input or an output.
9	12	S8	Source Terminal 8. Can be an input or an output.
10	13	S7	Source Terminal 7. Can be an input or an output.
11	14	S6	Source Terminal 6. Can be an input or an output.
12	15	S5	Source Terminal 5. Can be an input or an output.
13	17	V _{DD}	Most Positive Power Supply Potential.
14	18	GND	Ground (0 V) Reference.
15	19	A2	Logic Control Input.
16	20	A1	Logic Control Input.
N/A	1	NC	No Connect.
N/A	6	NC	No Connect.
N/A	11	NC	No Connect.
N/A	16	NC	No Connect.

Table 5. ADG508A Truth Table

A2	A1	A0	EN	On Switch
X ¹	X ¹	X ¹	0	None
0	0	0	1	1
0	0	1	1	2
0	1	0	1	3
0	1	1	1	4
1	0	0	1	5
1	0	1	1	6
1	1	0	1	7
1	1	1	1	8

¹ X = don't care.



Figure 6. ADG509A DIP, SOIC



Figure 7. ADG509A PLCC

Table 6. ADG509A Pin Function Description

Pin Number		Mnemonic	Description
DIP/SOIC	PLCC/LCC		
1	2	A0	Logic Control Input.
2	3	EN	Active High Digital Input. When low, the device is disabled and all switches are off. When high, Ax logic inputs determine on switches.
3	4	V _{SS}	Most Negative Power Supply Potential in Dual Supplies. In single-supply applications, it can be connected to ground.
4	5	S1A	Source Terminal 1A. Can be an input or an output.
5	7	S2A	Source Terminal 2A. Can be an input or an output.
6	8	S3A	Source Terminal 3A. Can be an input or an output.
7	9	S4A	Source Terminal 4A. Can be an input or an output.
8	10	DA	Drain Terminal A. Can be an input or an output.
9	12	DB	Drain Terminal B. Can be an input or an output.
10	13	S4B	Source Terminal 4B. Can be an input or an output.
11	14	S3B	Source Terminal 3B. Can be an input or an output.
12	15	S2B	Source Terminal 2B. Can be an input or an output.
13	17	S1B	Source Terminal 1B. Can be an input or an output.
14	18	V _{DD}	Most Positive Power Supply Potential.
15	19	GND	Ground (0 V) Reference.
16	20	A1	Logic Control Input.
N/A	1	NC	No Connect.
N/A	6	NC	No Connect.
N/A	11	NC	No Connect.
N/A	16	NC	No Connect.

Table 7. ADG509A Truth Table

A1	A0	EN	On Switch Pair
X ¹	X ¹	0	None
0	0	1	1
0	1	1	2
1	0	1	3
1	1	1	4

¹X = don't care.

TYPICAL PERFORMANCE CHARACTERISTICS

The multiplexers are guaranteed functional with reduced single or dual supplies down to 4.5 V.



Figure 8. R_{ON} as a Function of V_D (V_S): Dual-Supply Voltage, $T_A = 25^\circ\text{C}$



Figure 11. R_{ON} as a Function of V_D (V_S) Single-Supply Voltage, $T_A = 25^\circ\text{C}$



Figure 9. Leakage Current as a Function of Temperature
(Note: Leakage Currents Reduce as the Supply Voltages Reduce)



Figure 12. Trigger Levels vs. Power Supply Voltage, Dual or Single Supply, $T_A = 25^\circ\text{C}$



Figure 10. $t_{TRANSITION}$ vs. Supply Voltage: Dual and Single Supplies, $T_A = 25^\circ\text{C}$
(Note: For V_{DD} and $|V_{SS}| < 10\text{V}$; $V1 = V_{DD}/V_{SS}$, $V2 = V_{SS}/V_{DD}$. (see Figure 19))



Figure 13. I_{DD} vs. Supply Voltage: Dual or Single Supply, $T_A = 25^\circ\text{C}$

TEST CIRCUITS

Note: All digital input signal rise and fall times measured from 10% to 90% of 3 V. $t_R = t_F = 20$ ns.



Figure 14. R_{ON}

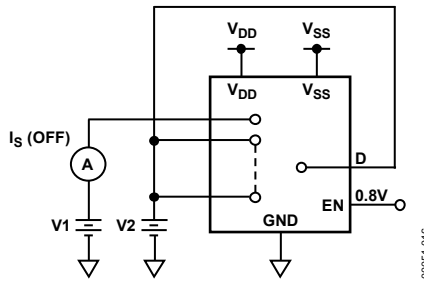

Figure 15. I_S (Off)

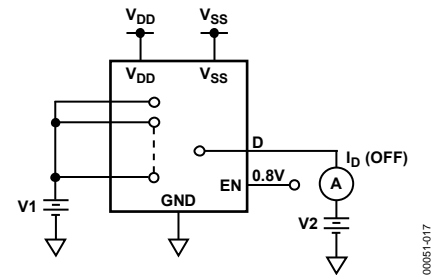

Figure 16. I_D (Off)



Figure 17. I_D (On)



Figure 18. $I_{DIFF} = I_{DB}$ (Off)



Figure 19. Switching Time of Multiplexer, $t_{TRANSITION}$

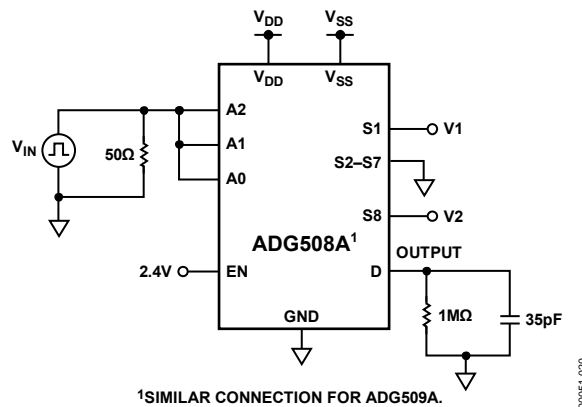

¹SIMILAR CONNECTION FOR ADG509A.

ADG508A/ADG509A



Figure 20. Break-Before-Make Delay, t_{OPEN}



Figure 21. Enable Delay, $t_{ON}(EN)$, $t_{OFF}(EN)$



Figure 22. Charge Injection

SINGLE-SUPPLY OCTAL DAC APPLICATION

The following circuit shows the ADG508A connected as a demultiplexer to provide eight separate, digitally programmable voltages (0 V to 10 V) from the AD7245A. The AD7245A is a complete 12-bit, voltage output DAC with output amplifier and Zener voltage reference on a monolithic CMOS chip.

The entire system operates from a single 15 V power supply. The ADG508A is ideally suited for the application because it has both low charge injection and I_s (OFF) leakage current.



Figure 23. ADG508A in a Single-Supply Octal DAC Circuit

00051-024

OUTLINE DIMENSIONS



COMPLIANT TO JEDEC STANDARDS MS-001-AB
 CONTROLLING DIMENSIONS ARE IN INCHES; MILLIMETER DIMENSIONS
 (IN PARENTHESES) ARE ROUNDED-OFF INCH EQUIVALENTS FOR
 REFERENCE ONLY AND ARE NOT APPROPRIATE FOR USE IN DESIGN.
 CORNER LEADS MAY BE CONFIGURED AS WHOLE OR HALF LEADS.

Figure 24. 16-Lead Plastic Dual In-Line Package [PDIP]
 Narrow Body (N-16)
 Dimensions shown in inches and (millimeters)

073106-B



CONTROLLING DIMENSIONS ARE IN INCHES; MILLIMETER DIMENSIONS
 (IN PARENTHESES) ARE ROUNDED-OFF INCH EQUIVALENTS FOR
 REFERENCE ONLY AND ARE NOT APPROPRIATE FOR USE IN DESIGN.

Figure 25. 16-Lead Ceramic Dual In-Line Package [CERDIP]
 (Q-16)
 Dimensions shown in inches and (millimeters)



COMPLIANT TO JEDEC STANDARDS MS-012-AC
 CONTROLLING DIMENSIONS ARE IN MILLIMETERS; INCH DIMENSIONS
 (IN PARENTHESES) ARE ROUNDED-OFF MILLIMETER EQUIVALENTS FOR
 REFERENCE ONLY AND ARE NOT APPROPRIATE FOR USE IN DESIGN.

Figure 26. 16-Lead Standard Small Outline Package [SOIC_N]
 Narrow Body (R-16)
 Dimensions shown in millimeters and (inches)

060606-A



COMPLIANT TO JEDEC STANDARDS MO-047-AA
 CONTROLLING DIMENSIONS ARE IN INCHES; MILLIMETER DIMENSIONS
 (IN PARENTHESES) ARE ROUNDED-OFF INCH EQUIVALENTS FOR
 REFERENCE ONLY AND ARE NOT APPROPRIATE FOR USE IN DESIGN.

Figure 27. 20-Lead Plastic Leaded Chip Carrier [PLCC]
 (P-20)
 Dimensions shown in inches and (millimeters)

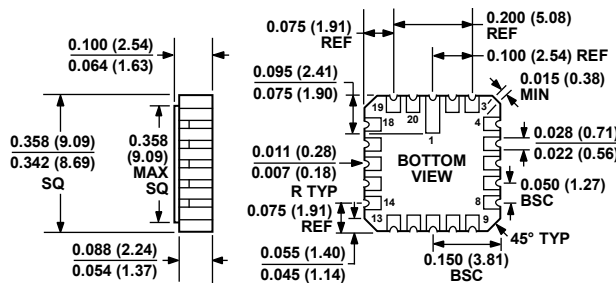

CONTROLLING DIMENSIONS ARE IN INCHES; MILLIMETER DIMENSIONS
 (IN PARENTHESES) ARE ROUNDED-OFF INCH EQUIVALENTS FOR
 REFERENCE ONLY AND ARE NOT APPROPRIATE FOR USE IN DESIGN.

Figure 28. 20-Terminal Ceramic Leadless Chip Carrier [LCC]
 (E-20-1)
 Dimensions shown in inches and (millimeters)

022106-A

ADG508A/ADG509A

ORDERING GUIDE

Model	Temperature Range	Package Description	Package Option
ADG508AKN	-40°C to +85°C	16-Lead Plastic Dual In-Line Package [PDIP]	N-16
ADG508AKNZ ¹	-40°C to +85°C	16-Lead Plastic Dual In-Line Package [PDIP]	N-16
ADG508AKR	-40°C to +85°C	16-Lead Standard Small Outline Package [SOIC_N]	R-16
ADG508AKR-REEL	-40°C to +85°C	16-Lead Standard Small Outline Package [SOIC_N]	R-16
ADG508AKR-REEL7	-40°C to +85°C	16-Lead Standard Small Outline Package [SOIC_N]	R-16
ADG508AKRZ ¹	-40°C to +85°C	16-Lead Standard Small Outline Package [SOIC_N]	R-16
ADG508AKRZ-REEL ¹	-40°C to +85°C	16-Lead Standard Small Outline Package [SOIC_N]	R-16
ADG508AKRZ-REEL7 ¹	-40°C to +85°C	16-Lead Standard Small Outline Package [SOIC_N]	R-16
ADG508AKP	-40°C to +85°C	20-Lead Plastic Leaded Chip Carrier [PLCC]	P-20
ADG508AKP-REEL	-40°C to +85°C	20-Lead Plastic Leaded Chip Carrier [PLCC]	P-20
ADG508AKPZ ¹	-40°C to +85°C	20-Lead Plastic Leaded Chip Carrier [PLCC]	P-20
ADG508AKPZ-REEL ¹	-40°C to +85°C	20-Lead Plastic Leaded Chip Carrier [PLCC]	P-20
ADG508ABQ	-40°C to +85°C	16-Lead Ceramic Dual In-Line Package [CERDIP]	Q-16
ADG508ATQ	-55°C to +125°C	16-Lead Ceramic Dual In-Line Package [CERDIP]	Q-16
ADG508ATE	-55°C to +125°C	20-Terminal Ceramic Leadless Chip Carrier [LCC]	E-20-1
ADG508ABCHIPS		DIE	
ADG508ATCHIPS		DIE	
ADG509AKN	-40°C to +85°C	16-Lead Plastic Dual In-Line Package [PDIP]	N-16
ADG509AKNZ ¹	-40°C to +85°C	16-Lead Plastic Dual In-Line Package [PDIP]	N-16
ADG509AKR	-40°C to +85°C	16-Lead Standard Small Outline Package [SOIC_N]	R-16
ADG509AKR-REEL	-40°C to +85°C	16-Lead Standard Small Outline Package [SOIC_N]	R-16
ADG509AKR-REEL7	-40°C to +85°C	16-Lead Standard Small Outline Package [SOIC_N]	R-16
ADG509AKRZ-REEL ¹	-40°C to +85°C	16-Lead Standard Small Outline Package [SOIC_N]	R-16
ADG509AKRZ-REEL7 ¹	-40°C to +85°C	16-Lead Standard Small Outline Package [SOIC_N]	R-16
ADG509AKP	-40°C to +85°C	20-Lead Plastic Leaded Chip Carrier [PLCC]	P-20
ADG509AKP-REEL	-40°C to +85°C	20-Lead Plastic Leaded Chip Carrier [PLCC]	P-20
ADG509AKPZ ¹	-40°C to +85°C	20-Lead Plastic Leaded Chip Carrier [PLCC]	P-20
ADG509AKPZ-REEL ¹	-40°C to +85°C	20-Lead Plastic Leaded Chip Carrier [PLCC]	P-20
ADG509ABQ	-40°C to +85°C	16-Lead Ceramic Dual In-Line Package [CERDIP]	Q-16
ADG509ATQ	-55°C to +125°C	16-Lead Ceramic Dual In-Line Package [CERDIP]	Q-16
ADG509ATQ/883B	-55°C to +125°C	16-Lead Ceramic Dual In-Line Package [CERDIP]	Q-16
ADG509ABCHIPS		DIE	
ADG509ATCHIPS		DIE	

¹ Z = RoHS Compliant Part.



Компания «ЭлектроПласт» предлагает заключение долгосрочных отношений при поставках импортных электронных компонентов на взаимовыгодных условиях!

Наши преимущества:

- Оперативные поставки широкого спектра электронных компонентов отечественного и импортного производства напрямую от производителей и с крупнейших мировых складов;
- Поставка более 17-ти миллионов наименований электронных компонентов;
- Поставка сложных, дефицитных, либо снятых с производства позиций;
- Оперативные сроки поставки под заказ (от 5 рабочих дней);
- Экспресс доставка в любую точку России;
- Техническая поддержка проекта, помощь в подборе аналогов, поставка прототипов;
- Система менеджмента качества сертифицирована по Международному стандарту ISO 9001;
- Лицензия ФСБ на осуществление работ с использованием сведений, составляющих государственную тайну;
- Поставка специализированных компонентов (Xilinx, Altera, Analog Devices, Intersil, Interpoint, Microsemi, Aeroflex, Peregrine, Syfer, Eurofarad, Texas Instrument, Miteq, Cobham, E2V, MA-COM, Hittite, Mini-Circuits, General Dynamics и др.);

Помимо этого, одним из направлений компании «ЭлектроПласт» является направление «Источники питания». Мы предлагаем Вам помощь Конструкторского отдела:

- Подбор оптимального решения, техническое обоснование при выборе компонента;
- Подбор аналогов;
- Консультации по применению компонента;
- Поставка образцов и прототипов;
- Техническая поддержка проекта;
- Защита от снятия компонента с производства.



Как с нами связаться

Телефон: 8 (812) 309 58 32 (многоканальный)

Факс: 8 (812) 320-02-42

Электронная почта: org@eplast1.ru

Адрес: 198099, г. Санкт-Петербург, ул. Калинина, дом 2, корпус 4, литера А.