

**Type SWS (6 positions)**

With shock-safe fuseholder 5 x 20 mm, Series-parallel connections for panel mounting, set by screwdriver or coin. Solder terminals or quick connect terminals 2,8 x 0,5 mm



**Typ SWS (6stufig)**

Mit berührungssicherem G-Sich.-Halter 5 x 20 mm, Serie-Parallelschaltung, für Frontplattenmontage, mit Münze oder Schraubenzieher einstellbar. Lötanschlüsse oder Steckanschlüsse 2,8 x 0,5 mm

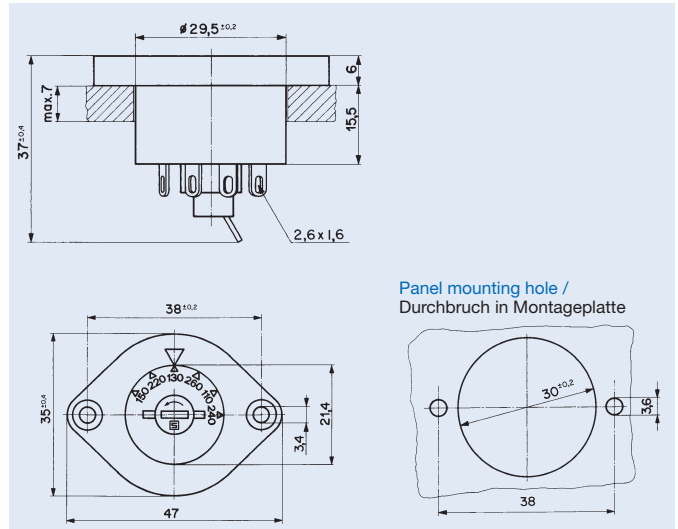

**Standards / Normen**

IEC/EN 61058-2-5, IEC/EN 60127-6, UL 508, CSA C 22.2/55

**Patents / Patente**

No. 4.072.385 (conc. fuseholder / betrifft G-Sicherungshalter)

**Approvals / Approbationen**

- SEMKO (6,3 A / 250 V) **pending / ausstehend**
- UL (6,3 A / 250 V)
- CSA (10 A / 250 V)

**Order No. / Bestell-Nr.**

See page 6 / Siehe Seite 6

**Type SWP (6 positions)**

Step switch for panel mounting set by screwdriver or coin. Solder terminals



**Typ SWP (6stufig)**

Stufenschaltung für Frontplattenmontage, mit Münze oder Schraubenzieher einstellbar. Lötanschlüsse

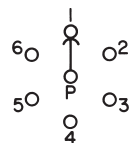

**Standards / Normen**

IEC/EN 61058-2-5, UL 508, CSA C 22.2/55

**Approvals / Approbationen**

- SEMKO (6,3 A / 250 V) **pending / ausstehend**
- UL (8 A / 250 V)
- CSA (10 A / 250 V)

**Technical data:**

- Rated voltage/current 6,3 A/250 V
- Material:
  - Socket: thermoplastic, black, UL 94V-0

**Technische Daten**

- Nennspannung/Nennstrom: 6,3 A/250 V
- Material:
  - Sockel: Thermoplast, schwarz, UL 94V-0

Other voltage markings see page 6 (min. order quantity 100 pieces) / Andere Spannungswerte siehe Seite 6 (Bestellmenge min. 100 Stück)

Additional technical data see page 7 / Zusätzliche technische Daten siehe Seite 7

**VOLTAGE SELECTOR SWITCHES / SPANNUNGSWÄHLER**

**Selector charts for voltage selector legends**

**Auswahltabelle für bestehende Spannungswähler-Beschriftungen**



**Table / Tabelle 1**  
**SWA – Series / Serien**

Order No. / Panel mount / Solder terminals	Order No. / PCB mount / Leiterplattenmontage	Legends (Position 1+2)	
		1	2
Bestell-Nr. Frontmontage Lötanschlüsse	Bestell-Nr. Leiterplattenmontage	Beschriftungen (Position 1+2)	
0033.4501	0033.4601	110	220
0033.4502		115	220
0033.4503	0033.4603	120	240
0033.4504	0033.4604	115	230
0033.4505		220	240
0033.4508		50 Hz	60 Hz
0033.4510		230	240
0033.4513		LO	HI
0033.4514			
0033.4515	0033.4615	120	230
0033.4518		0	1
	0033.4619	100	230
0033.4521		A	Bv
0033.4524		Test	run

**Table / Tabelle 2**  
**SWM – Series / Serien**

Order No. / Panel mount / Solder terminals	Order No. / PCB mount / Leiterplattenmontage	Legends (Position 1-3)		
		1	2	3
Bestell-Nr. Frontmontage Lötanschlüsse	Bestell-Nr. Leiterplattenmontage	Beschriftungen (Position 1-3)		
0033.4001		110	150	220
0033.4002	0033.4202	110	220	240
0033.4003		220	240	
0033.4004		200	220	240
0033.4006		220	240	250
0033.4008	0033.4208	100	115	230
0033.4011		220	230	240
0033.4014	0033.4214			
0033.4019		115	220	240
0033.4028		220V	230V	240V
0033.4032		4	8	16
0033.4040		100	110	230
0033.4044		115	0	230
0033.4049		230	240	250
	0033.4252	220-240	127	100-115
	0033.4254	230	0	200
0033.4055		115V	230V	240V
0033.4056		1	2	3
	0033.4259	115	200	230
0033.4057		100	120	230-240
0033.4062		110		230

**Table / Tabelle 3**  
**SWZ – Series / Serien**

Order No. / Panel mount / Solder terminals	Order No. / PCB mount / Leiterplattenmontage	Legends (Position 1-6)					
		1	2	3	4	5	6
Bestell-Nr. Frontmontage Lötanschlüsse	Bestell-Nr. Leiterplattenmontage	Beschriftungen (Position 1-6)					
0033.3501	0033.3801	150	220	130	260	110	240
0033.3502			120	240	110		
0033.3503			115	230			
	0033.3803	134	200	117	234	100	217
0033.3504	0033.3802	130	220	120	240	110	230
	0033.3804	127	200	115	240	100	220
0033.3505	0033.3805	140	200	120	240	100	220
0033.3510		127	200	115	240	100	220
	0033.3812	100	240	-	220	120	-
0033.3514							
	0033.3815	120	220	100	240		
0033.3518			220	130		110	240
	0033.3819		220			110	240
0033.3522				110	220		
0033.3527		0	220	120	0	100	230
0033.3530		100	240		220	120	
	0033.3833	145	210	125	250	105	230
	0033.3837		200	120	240	100	220
0033.3539		130	200	115	230	100	215
	0033.3839	130	200	115	230	100	215
	0033.3843						
	0033.3845			120	240	100	230
	0033.3846	120	220	115	230	110	225
0033.3547			200	120	240	100	
0033.3549		100	0	117	220	100	240
0033.3553		140	200	120	240	100	230
0033.3555				120	240	100	220
0033.3558		140	200	120	230/240	100	220/230
0033.3560		127	220	115	240	110	230

**Table / Tabelle 4**  
**SWS – Series / Serien**

Order No. / Bestell-Nr.	Quick con term. / Flachstecker	Legends / Beschriftungen (Pos. 1-6)					
		1	2	3	4	5	6
0033.6001	0033.6101	150	220	130	260	110	240
0033.6003				110	220		
0033.6004	0033.6104	140	200	120	240	100	220
0033.6006		130	220	120	240	110	230
0033.6009		127	200	115	240	100	220
0033.6015			120	240	100	220	
0033.6016			220	120		240	
0033.6019			200	120	240	100	220
0033.6022	0033.6122		220	120		100	240
0033.6024		130	200	115	230	100	220
0033.6026		120	220			100	240
	0033.6127		240	100		120	220
0033.6030			200	115	230	100	215
0033.6031			220			110	240

**Table / Tabelle 5**  
**SWP – Series / Serien**

Order No. / Bestell-Nr.	Legends / Beschriftungen (Pos. 1-6)					
	1	2	3	4	5	6
0033.1101	110V	125V	145V	160V	220V	250V
0033.1104						
0033.1108	A00L	A51L	A27L		220V	240V
0033.1109	100V	115V	120V	220V	240V	
0033.1110	100V	115V	200V	220V	230V	240V
0033.1113	100V	115V	125V	200V	220V	240V
0033.1118		100V	115V	220V	240V	
0033.1119	100V	110V	120V	200V	220V	240V
0033.1120	100V	110V	220V	240V		
0033.1125	110V	115V	130V	200V	230V	
0033.1127	100V	120V	200V	220V	230V	240V
0033.1128	100V	110V	120V	127V	220V	240V
0033.1130	100V	110V	120V	125V	230V	240V
0033.1133	4 Ω	8 Ω	16 Ω			
0033.1134	110V	220V	230V			
0033.1135	100	120	200	230	0	0
0033.1136	100	120	200	208	230	0
0033.1137	100	115	230	240		
0033.1140	1	2	3	4	5	0

**Table / Tabelle 6**  
**SWG – Series / Serien**

Order No. / Bestell-Nr.	Legends / Beschriftungen (Position 1-6)					
	1	2	3	4	5	6
0033.2500	110	125	150	200	220	250
0033.2506	208	220	240			
0033.2507	100	110	120	200	220	240
0033.2510	100	115	220	230	240	
0033.2511	200V	208V	220V	230V	240V	NC
0033.2512	100V	120V	200V	220V	240V	
0033.2514						
0033.2517	240V	230V	220V	208V	115V	100V
0033.2520	100	115	220	240		



























**Fuse Cap FEU has to be ordered separately:**  
Sicherungskopf FEU muss separat bestellt werden:  
0031.1663 for fuse 5 x 20 mm  
0031.1661 for fuse 6.3 x 32 mm

**Table / Tabelle 7**  
**SWK – Series / Serien**

Order No. / Bestell-Nr.	Legends / Beschriftungen (Position 1-6)					
	1	2	3	4	5	6
0033.1500	110	125	150	200	220	250
0033.1502				220	230	240
0033.1504	100	110	120	200	220	240
0033.1510	1	2	3	4	5	6
0033.1511	100	110	120	220	230	240
0033.1513	200	208	220	230	240	
0033.1514						
0033.1515	110	130	220	240		
0033.1517	100	120	220	240		
0033.1518		100	120	220	240	
0033.1520	100	115	220	240		
0033.1523	100V	120V	200V	220V	230V	240V
0033.1525	200	220	230	240	250	

**No articles from stock, minimum order quantity 100 pieces / Keine Lagerartikel, Bestellmenge min. 100 Stück**

## VOLTAGE SELECTOR SWITCHES / SPANNUNGSWÄHLER

Type / Typ										
Page / Seite	1	1	2	2	3	3	4	4	5	5
SEMKO-Approval: pending / Zulassung: ausstehend	 6,3A/250V 50Hz	 6,3A/250V 50Hz	 6,3A/250V 50Hz	 6,3A/250V 50Hz	 6,3A/250V 50Hz	 6,3 A/250 V 50Hz	 6,3A/250V 50Hz	 6,3A/250V 50Hz	 6,3A/250V 50Hz	 6,3A/250V 50Hz
UL-Recognition	 6,3A/250V 60Hz	 6,3A/250V 60Hz	 10 A/250V 60Hz	 10 A/250V 60Hz	 10 A/250V 60Hz	 10 A/250V 60Hz	 10 A/250V 60Hz	 10 A/250V 60Hz	 6,3A/250V 60Hz	 6,3A/250V 60Hz
CSA-Certification	 6,3A/250V 60Hz	 6,3A/250V 60Hz	 6,3A/250V 60Hz	 6,3A/250V 60Hz	 6,3A/250V 60Hz	 8 A/250V 60Hz	 10 A/250V 60Hz	 10 A/250V 60Hz	 10 A/250V 60Hz	 10 A/250V 60Hz
Panel mounting / Frontplattenmontage	•		•		•	•	•		•	•
PCB mounting / Leiterplattenmontage		•		•				•		
Shock-safe fuseholder for 5 x 20 mm fuse-links / Berührungssicherer G-Sicherungs- halter für 5 x 20 mm G-Sich.einsätze					•				•	•
Shock-safe fuseholder for 6,3 x 32 mm (1/4" x 1 1/4") fuse-links Berührungssicherer G-Sicherungsh. für 6,3 x 32 mm G-Sich.einsätze										•
Solder terminals / Lötanschlüsse	•		•		•	•	•		•	•
Quick connect terminals / Steckanschlüsse 2,8 x 0,5 mm					•					
Number of different voltages / Anzahl möglicher Spannungen	2	2	6	6	6	6	3	3	6	6
Operating cycles / Anzahl Schaltzyklen	300	300	300	300	300	300	300	300	300	300
Insulation resist. at 500 V DC/1 Min. / Isolationswiderst. bei 500 V DC/1 Min.	> 10 <sup>4</sup> MΩ	> 10 <sup>4</sup> MΩ	> 10 <sup>4</sup> MΩ	> 10 <sup>3</sup> MΩ	> 10 <sup>4</sup> MΩ	> 10 <sup>3</sup> MΩ	> 10 <sup>4</sup> MΩ	> 10 <sup>4</sup> MΩ	> 10 <sup>4</sup> MΩ	> 10 <sup>4</sup> MΩ
Contact-resistance / Durchgangswiderstand	< 10 mΩ	< 10 mΩ	< 10 mΩ	< 10 mΩ	< 10 mΩ	< 10 mΩ	< 10 mΩ	< 10 mΩ	< 10 mΩ	< 10 mΩ
Dielectric strenght between metal mounting plate and live parts 50 Hz, 1 Min. / Spannungsfestigkeit zwischen Metall- montageplatte und unter Spannung stehenden Teilen 50 Hz, 1 Min.	>4 kV	>4 kV	>4 kV	>4 kV	>4 kV	>4 kV	>4 kV	>4 kV	>4 kV	>4 kV
Dielectric strenght between live parts of different potentials 50 Hz, 1 Min. / Spannungsfestigkeit zwischen unter Spannung stehenden Teilen mit unter- schiedlichem Potential 50 Hz, 1 Min.	>2 kV	>2 kV	>2 kV	>2 kV	>2 kV	>2,5 kV	>2 kV	>2 kV	>2 kV	>2 kV
Clearance and creepage distances / Kriech- und Luftstrecken	> 3 mm	> 3 mm	> 3 mm	> 3 mm	> 3 mm	> 5 mm	> 3 mm	> 3 mm	> 3 mm	> 3 mm
Temperature (+55 °C for accessible parts only) / Temperaturbereich (+55 °C für leicht zugängliche Teile)	-40 °C ÷ +85 °C	-40 °C ÷ +85 °C	-40 °C ÷ +85 °C	-40 °C ÷ +85 °C	-40 °C ÷ +70 °C	-40 °C ÷ +85 °C	-40 °C ÷ +85 °C	-40 °C ÷ +85 °C	-40 °C ÷ +85 °C	-40 °C ÷ +70 °C
Protection class II: / Schutzklasse II: IEC 61140	•	•	•	•	•		•	•	•	•
Shocksafe category: / Berührungsschutz Kategorie					PC 2				PC 2	PC 2
Step switch / Stufenschaltung						•	•	•	•	•
Series-parallel connections / Serie-Parallelschaltung	•	•	•	•	•					



Компания «ЭлектроПласт» предлагает заключение долгосрочных отношений при поставках импортных электронных компонентов на взаимовыгодных условиях!

Наши преимущества:

- Оперативные поставки широкого спектра электронных компонентов отечественного и импортного производства напрямую от производителей и с крупнейших мировых складов;
- Поставка более 17-ти миллионов наименований электронных компонентов;
- Поставка сложных, дефицитных, либо снятых с производства позиций;
- Оперативные сроки поставки под заказ (от 5 рабочих дней);
- Экспресс доставка в любую точку России;
- Техническая поддержка проекта, помощь в подборе аналогов, поставка прототипов;
- Система менеджмента качества сертифицирована по Международному стандарту ISO 9001;
- Лицензия ФСБ на осуществление работ с использованием сведений, составляющих государственную тайну;
- Поставка специализированных компонентов (Xilinx, Altera, Analog Devices, Intersil, Interpoint, Microsemi, Aeroflex, Peregrine, Syfer, Eurofarad, Texas Instrument, Miteq, Cobham, E2V, MA-COM, Hittite, Mini-Circuits, General Dynamics и др.);

Помимо этого, одним из направлений компании «ЭлектроПласт» является направление «Источники питания». Мы предлагаем Вам помощь Конструкторского отдела:

- Подбор оптимального решения, техническое обоснование при выборе компонента;
- Подбор аналогов;
- Консультации по применению компонента;
- Поставка образцов и прототипов;
- Техническая поддержка проекта;
- Защита от снятия компонента с производства.



#### Как с нами связаться

**Телефон:** 8 (812) 309 58 32 (многоканальный)

**Факс:** 8 (812) 320-02-42

**Электронная почта:** [org@eplast1.ru](mailto:org@eplast1.ru)

**Адрес:** 198099, г. Санкт-Петербург, ул. Калинина, дом 2, корпус 4, литера А.