

**FEATURES**

- ±15 kV ESD protection on output pins**
- 600 Mbps (300 MHz) switching rates**
- Flow-through pinout simplifies PCB layout**
- 300 ps typical differential skew**
- 700 ps maximum differential skew**
- 1.5 ns maximum propagation delay**
- 3.3 V power supply**
- ±355 mV differential signaling**
- Low power dissipation: 23 mW typical**
- Interoperable with existing 5 V LVDS receivers**
- Conforms to TIA/EIA-644 LVDS standard**
- Industrial operating temperature range (−40°C to +85°C)**
- Available in surface-mount (SOIC) package**

**APPLICATIONS**

- Backplane data transmission**
- Cable data transmission**
- Clock distribution**

**GENERAL DESCRIPTION**

The ADN4663 is a dual, CMOS, low voltage differential signaling (LVDS) line driver offering data rates of over 600 Mbps (300 MHz), and ultralow power consumption. It features a flow-through pinout for easy PCB layout and separation of input and output signals.

The device accepts low voltage TTL/CMOS logic signals and converts them to a differential current output of typically ±3.1 mA for driving a transmission medium such as a

**FUNCTIONAL BLOCK DIAGRAM**

Figure 1.

07927-001

twisted-pair cable. The transmitted signal develops a differential voltage of typically ±355 mV across a termination resistor at the receiving end, and this is converted back to a TTL/CMOS logic level by a line receiver.

The ADN4663 and a companion receiver offer a new solution to high speed point-to-point data transmission, and a low power alternative to emitter-coupled logic (ECL) or positive emitter-coupled logic (PECL).

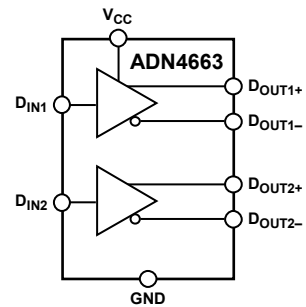
**Rev. 0**

Information furnished by Analog Devices is believed to be accurate and reliable. However, no responsibility is assumed by Analog Devices for its use, nor for any infringements of patents or other rights of third parties that may result from its use. Specifications subject to change without notice. No license is granted by implication or otherwise under any patent or patent rights of Analog Devices. Trademarks and registered trademarks are the property of their respective owners.

**TABLE OF CONTENTS**

Features .....	1	ESD Caution.....	6
Applications.....	1	Pin Configuration and Function Descriptions.....	7
Functional Block Diagram .....	1	Typical Performance Characteristics .....	8
General Description .....	1	Theory of Operation .....	11
Revision History .....	2	Applications Information .....	11
Specifications.....	3	Outline Dimensions .....	12
AC Characteristics.....	4	Ordering Guide .....	12
Absolute Maximum Ratings.....	6		

**REVISION HISTORY**

1/09—Revision 0: Initial Version

## SPECIFICATIONS

$V_{CC} = 3.0\text{ V to }3.6\text{ V}$ ;  $R_L = 100\ \Omega$ ;  $C_L = 15\text{ pF to GND}$ ; all specifications  $T_{MIN}$  to  $T_{MAX}$ , unless otherwise noted.

Table 1.

Parameter <sup>1,2</sup>	Symbol	Min	Typ	Max	Unit	Test Conditions
<b>LVDS OUTPUTS (<math>D_{OUTx+}</math>, <math>D_{OUTx-}</math>)</b>						
Differential Output Voltage	$V_{OD}$	250	355	450	mV	See Figure 2 and Figure 4
Change in Magnitude of $V_{OD}$ for Complementary Output States	$\Delta V_{OD}$		1	35	mV	See Figure 2 and Figure 4
Offset Voltage	$V_{OS}$	1.125	1.2	1.375	V	See Figure 2 and Figure 4
Change in Magnitude of $V_{OS}$ for Complementary Output States	$\Delta V_{OS}$		3	25	mV	See Figure 2 and Figure 4
Output High Voltage	$V_{OH}$		1.4	1.6	V	See Figure 2 and Figure 4
Output Low Voltage	$V_{OL}$	0.90	1.1		V	See Figure 2 and Figure 4
<b>INPUTS (<math>D_{IN1}</math>, <math>D_{IN2}</math>)</b>						
Input High Voltage	$V_{IH}$	2.0		$V_{CC}$	V	
Input Low Voltage	$V_{IL}$	GND		0.8	V	
Input High Current	$I_{IH}$	-10	$\pm 2$	+10	$\mu\text{A}$	$V_{IN} = 3.3\text{ V or }2.4\text{ V}$
Input Low Current	$I_{IL}$	-10	$\pm 1$	+10	$\mu\text{A}$	$V_{IN} = \text{GND or }0.5\text{ V}$
Input Clamp Voltage	$V_{CL}$	-1.5	-0.6		V	$I_{CL} = -18\text{ mA}$
<b>LVDS OUTPUT PROTECTION (<math>D_{OUTx+}</math>, <math>D_{OUTx-}</math>)</b>						
Output Short-Circuit Current <sup>3</sup>	$I_{OS}$		-5.7	-8.0	mA	$D_{INx} = V_{CC}$ , $D_{OUTx+} = 0\text{ V}$ or $D_{INx} = \text{GND}$ , $D_{OUTx-} = 0\text{ V}$
<b>LVDS OUTPUT LEAKAGE (<math>D_{OUTx+}</math>, <math>D_{OUTx-}</math>)</b>						
Power-Off Leakage	$I_{OFF}$	-10	$\pm 1$	+10	$\mu\text{A}$	$V_{OUT} = V_{CC}$ or $\text{GND}$ , $V_{CC} = 0\text{ V}$
<b>POWER SUPPLY</b>						
Supply Current, Unloaded	$I_{CC}$		8	14	mA	No load, $D_{INx} = V_{CC}$ or $\text{GND}$
Supply Current, Loaded	$I_{CCL}$		10	20	mA	$D_{INx} = V_{CC}$ or $\text{GND}$
<b>ESD PROTECTION</b>						
$D_{OUTx+}$ , $D_{OUTx-}$ Pins			$\pm 15$		kV	Human body model
All Pins Except $D_{OUTx+}$ , $D_{OUTx-}$			$\pm 4$		kV	Human body model

<sup>1</sup> Current into device pins is defined as positive. Current out of device pins is defined as negative. All voltages are referenced to ground except  $V_{OD}$ ,  $\Delta V_{OD}$ , and  $\Delta V_{OS}$ .

<sup>2</sup> The ADN4663 is a current mode device and functions within data sheet specifications only when a resistive load is applied to the driver outputs. Typical range is 90  $\Omega$  to 110  $\Omega$ .

<sup>3</sup> Output short-circuit current ( $I_{OS}$ ) is specified as magnitude only; minus sign indicates direction only.

# ADN4663

## AC CHARACTERISTICS

$V_{CC} = 3.0\text{ V}$  to  $3.6\text{ V}$ ;  $R_L = 100\ \Omega$ ;  $C_L^1 = 15\text{ pF}$  to GND; all specifications  $T_{MIN}$  to  $T_{MAX}$ , unless otherwise noted.

Table 2.

Parameter <sup>2</sup>	Symbol	Min	Typ	Max	Unit	Conditions/Comments <sup>3, 4</sup>
Differential Propagation Delay High to Low	$t_{PHLD}$	0.3	0.8	1.5	ns	See Figure 3 and Figure 4
Differential Propagation Delay Low to High	$t_{PLHD}$	0.3	1.1	1.5	ns	See Figure 3 and Figure 4
Differential Pulse Skew $ t_{PHLD} - t_{PLHD} ^5$	$t_{SKD1}$	0	0.3	0.7	ns	See Figure 3 and Figure 4
Channel-to-Channel Skew <sup>6</sup>	$t_{SKD2}$	0	0.4	0.8	ns	See Figure 3 and Figure 4
Differential Part-to-Part Skew <sup>7</sup>	$t_{SKD3}$	0		1.0	ns	See Figure 3 and Figure 4
Differential Part-to-Part Skew <sup>8</sup>	$t_{SKD4}$	0		1.2	ns	See Figure 3 and Figure 4
Rise Time	$t_{TLH}$	0.2	0.5	1.0	ns	See Figure 3 and Figure 4
Fall Time	$t_{THL}$	0.2	0.5	1.0	ns	See Figure 3 and Figure 4
Maximum Operating Frequency <sup>9</sup>	$f_{MAX}$		350		MHz	See Figure 3

<sup>1</sup>  $C_L$  includes probe and jig capacitance.

<sup>2</sup> AC parameters are guaranteed by design and characterization.

<sup>3</sup> Generator waveform for all tests, unless otherwise specified:  $f = 50\text{ MHz}$ ,  $Z_o = 50\ \Omega$ ,  $t_{TLH} \leq 1\text{ ns}$ , and  $t_{THL} \leq 1\text{ ns}$ .

<sup>4</sup> All input voltages are for one channel, unless otherwise specified. Other inputs are set to GND.

<sup>5</sup>  $t_{SKD1} = |t_{PHLD} - t_{PLHD}|$  is the magnitude difference in differential propagation delay time between the positive going edge and the negative going edge of the same channel.

<sup>6</sup>  $t_{SKD2}$  is the differential channel-to-channel skew of any event on the same device.

<sup>7</sup>  $t_{SKD3}$ , differential part-to-part skew, is defined as the difference between the minimum and maximum specified differential propagation delays. This specification applies to devices at the same  $V_{CC}$  and within  $5^\circ\text{C}$  of each other within the operating temperature range.

<sup>8</sup>  $t_{SKD4}$ , differential part-to-part skew, is the differential channel-to-channel skew of any event between devices. This specification applies to devices over recommended operating temperatures and voltage ranges, and across process distribution.  $t_{SKD4}$  is defined as  $|\text{maximum} - \text{minimum}|$  differential propagation delay.

<sup>9</sup>  $f_{MAX}$  generator input conditions:  $t_{TLH} = t_{THL} < 1\text{ ns}$  (0% to 100%), 50% duty cycle, 0 V to 3 V. Output criteria: duty cycle = 45% to 55%,  $V_{OD} > 250\text{ mV}$ , all channels switching.

Test Circuits and Timing Diagrams

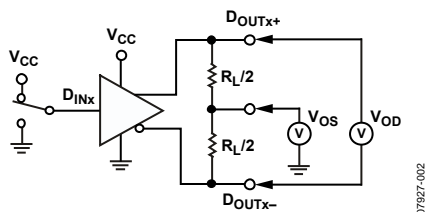
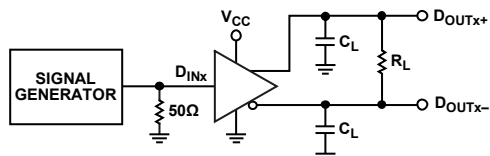

Figure 2. Test Circuit for Driver  $V_{OD}$  and  $V_{OS}$



$C_L$  INCLUDES LOAD AND TEST JIG CAPACITANCE.

Figure 3. Test Circuit for Driver Propagation Delay, Transition Time, and Maximum Operating Frequency

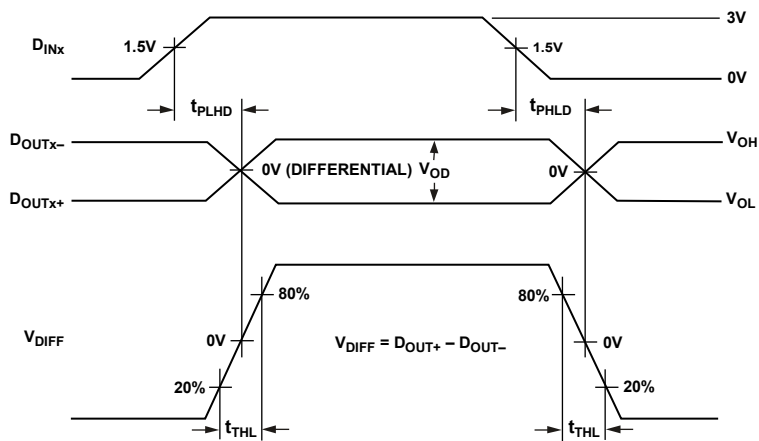

Figure 4. Driver Propagation Delay and Transition Time Waveforms

## ABSOLUTE MAXIMUM RATINGS

$T_A = 25^\circ\text{C}$ , unless otherwise noted. All voltages are relative to their respective ground.

Table 3.

Parameter	Rating
$V_{CC}$ to GND	-0.3 V to +4 V
Input Voltage ( $D_{INx}$ ) to GND	-0.3 V to $V_{CC} + 0.3$ V
Output Voltage ( $D_{OUTx+}$ , $D_{OUTx-}$ ) to GND	-0.3 V to $V_{CC} + 0.3$ V
Short-Circuit Duration ( $D_{OUTx+}$ , $D_{OUTx-}$ ) to GND	Continuous
Operating Temperature Range	
Industrial	$-40^\circ\text{C}$ to $+85^\circ\text{C}$
Storage Temperature Range	$-65^\circ\text{C}$ to $+150^\circ\text{C}$
Junction Temperature ( $T_J \text{ max}$ )	$150^\circ\text{C}$
Power Dissipation	$(T_J \text{ max} - T_A)/\theta_{JA}$
SOIC Package	
$\theta_{JA}$ Thermal Impedance	$149.5^\circ\text{C/W}$
Reflow Soldering Peak Temperature	
Pb-Free	$260^\circ\text{C} \pm 5^\circ\text{C}$

Stresses above those listed under Absolute Maximum Ratings may cause permanent damage to the device. This is a stress rating only; functional operation of the device at these or any other conditions above those indicated in the operational section of this specification is not implied. Exposure to absolute maximum rating conditions for extended periods may affect device reliability.

### ESD CAUTION



**ESD (electrostatic discharge) sensitive device.** Charged devices and circuit boards can discharge without detection. Although this product features patented or proprietary protection circuitry, damage may occur on devices subjected to high energy ESD. Therefore, proper ESD precautions should be taken to avoid performance degradation or loss of functionality.

## PIN CONFIGURATION AND FUNCTION DESCRIPTIONS

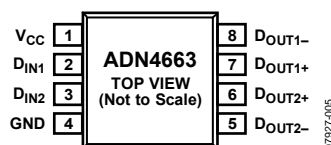

Figure 5. Pin Configuration

Table 4. Pin Function Descriptions

Pin No.	Mnemonic	Description
1	V <sub>CC</sub>	Power Supply Input. The part can be operated from 3.0 V to 3.6 V, and the supply should be decoupled with a 10 $\mu$ F solid tantalum capacitor in parallel with a 0.1 $\mu$ F capacitor to GND.
2	D <sub>IN1</sub>	Driver Channel 1 Logic Input.
3	D <sub>IN2</sub>	Driver Channel 2 Logic Input.
4	GND	Ground reference point for all circuitry on the part.
5	D <sub>OUT2-</sub>	Channel 2 Inverting Output Current Driver. When D <sub>IN2</sub> is high, current flows into D <sub>OUT2-</sub> . When D <sub>IN2</sub> is low, current flows out of D <sub>OUT2-</sub> .
6	D <sub>OUT2+</sub>	Channel 2 Noninverting Output Current Driver. When D <sub>IN2</sub> is high, current flows out of D <sub>OUT2+</sub> . When D <sub>IN2</sub> is low, current flows into D <sub>OUT2+</sub> .
7	D <sub>OUT1+</sub>	Channel 1 Noninverting Output Current Driver. When D <sub>IN1</sub> is high, current flows out of D <sub>OUT1+</sub> . When D <sub>IN1</sub> is low, current flows into D <sub>OUT1+</sub> .
8	D <sub>OUT1-</sub>	Channel 1 Inverting Output Current Driver. When D <sub>IN1</sub> is high, current flows into D <sub>OUT1-</sub> . When D <sub>IN1</sub> is low, current flows out of D <sub>OUT1-</sub> .

## TYPICAL PERFORMANCE CHARACTERISTICS

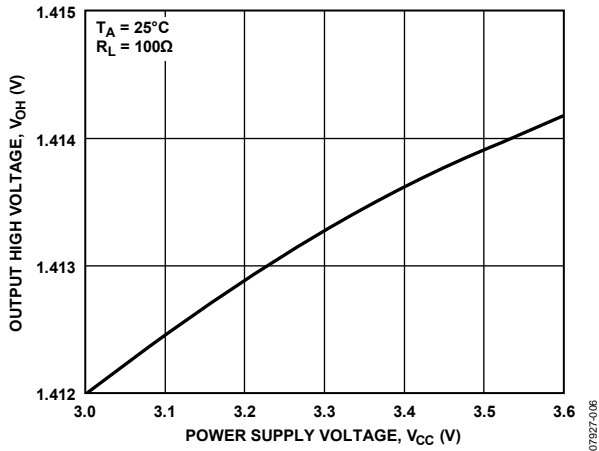

Figure 6. Output High Voltage vs. Power Supply Voltage

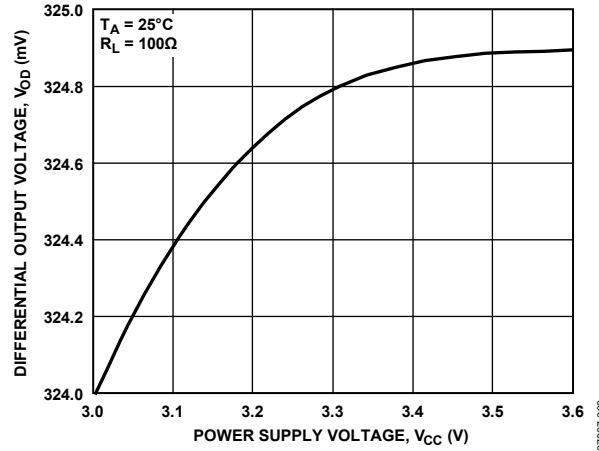

Figure 9. Differential Output Voltage vs. Power Supply Voltage

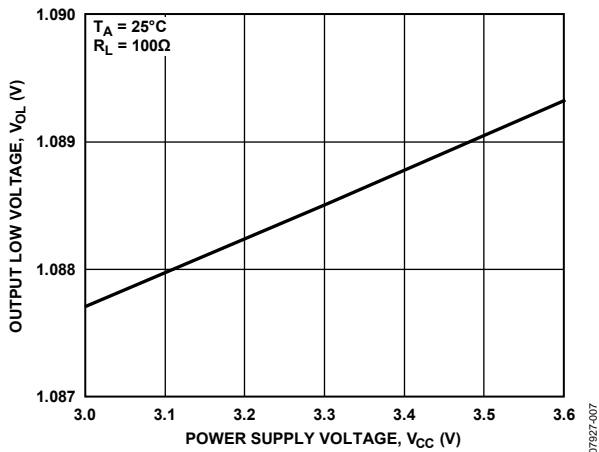

Figure 7. Output Low Voltage vs. Power Supply Voltage

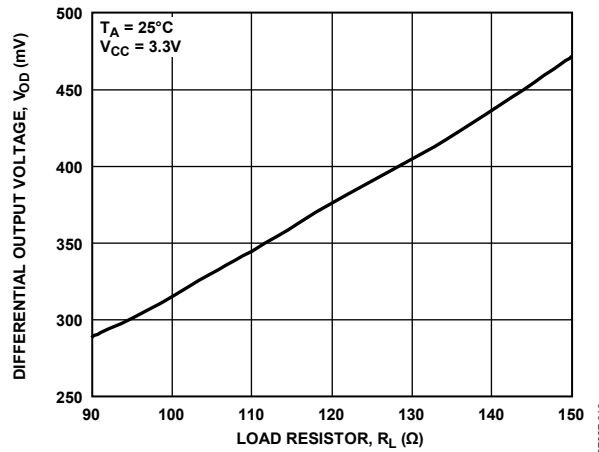

Figure 10. Differential Output Voltage vs. Load Resistor

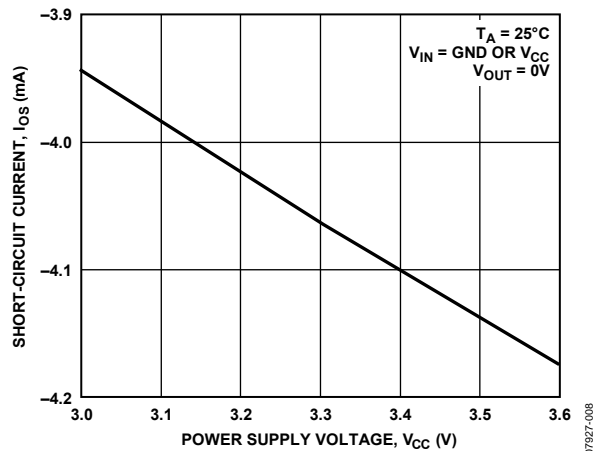

Figure 8. Output Short-Circuit Current vs. Power Supply Voltage

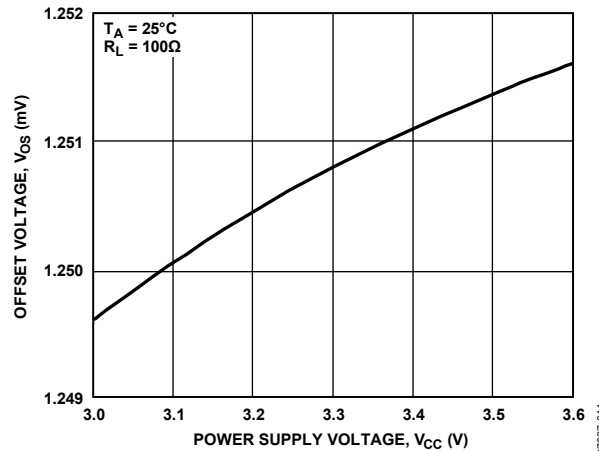

Figure 11. Offset Voltage vs. Power Supply Voltage



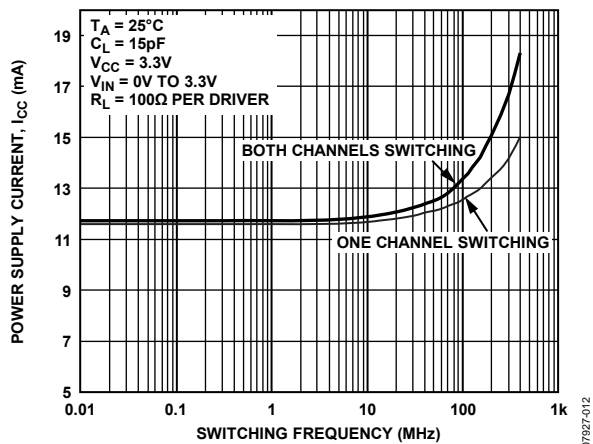

Figure 12. Power Supply Current vs. Switching Frequency

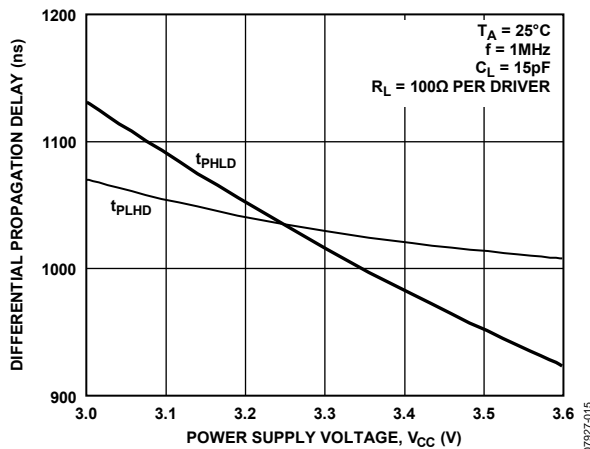

Figure 15. Differential Propagation Delay vs. Power Supply Voltage

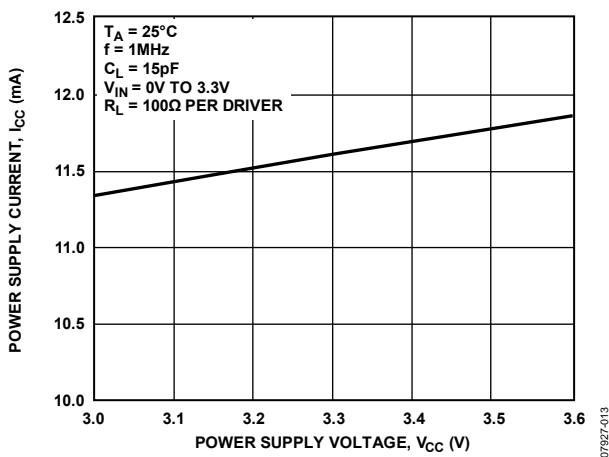

Figure 13. Power Supply Current vs. Power Supply Voltage

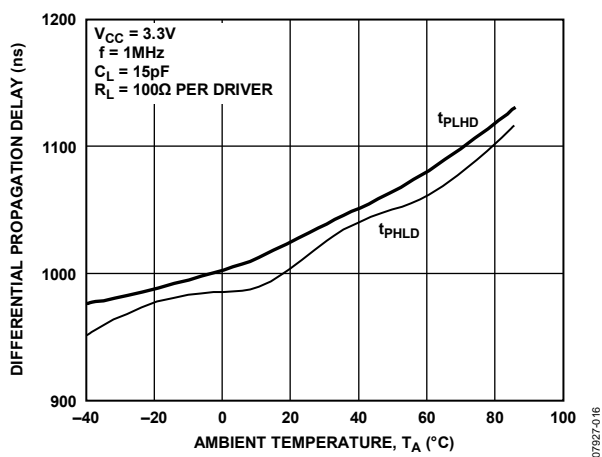

Figure 16. Differential Propagation Delay vs. Ambient Temperature

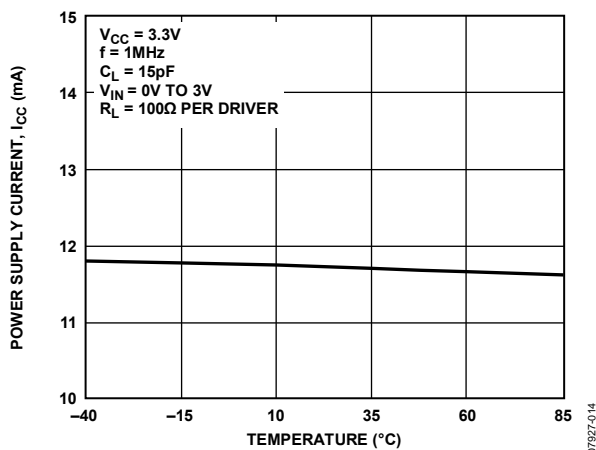

Figure 14. Power Supply Current vs. Ambient Temperature

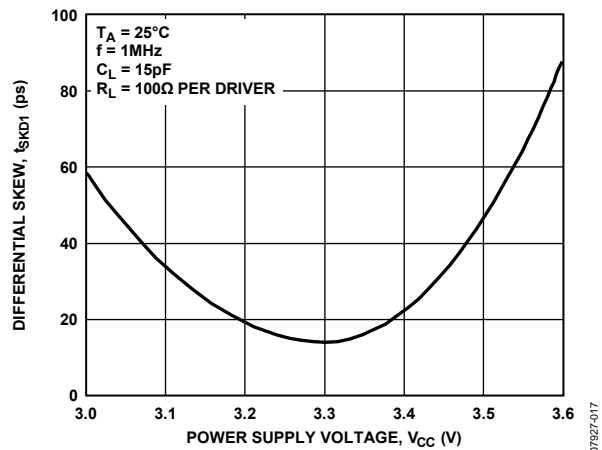

Figure 17. Differential Skew vs. Power Supply Voltage

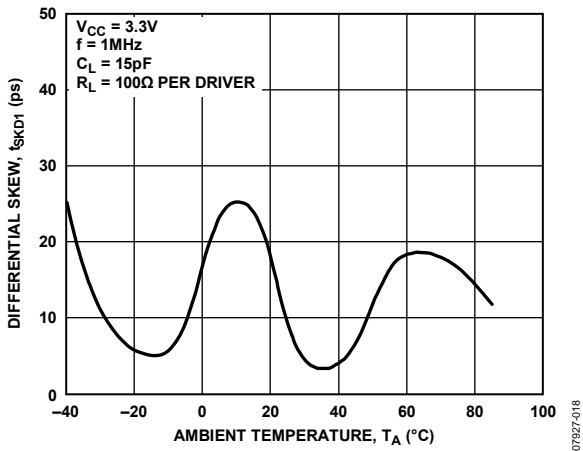

Figure 18. Differential Skew vs. Ambient Temperature

07927-018

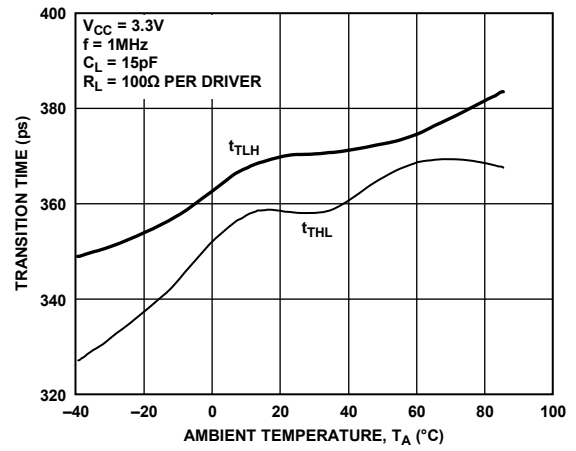

Figure 20. Transition Time vs. Ambient Temperature

07927-020

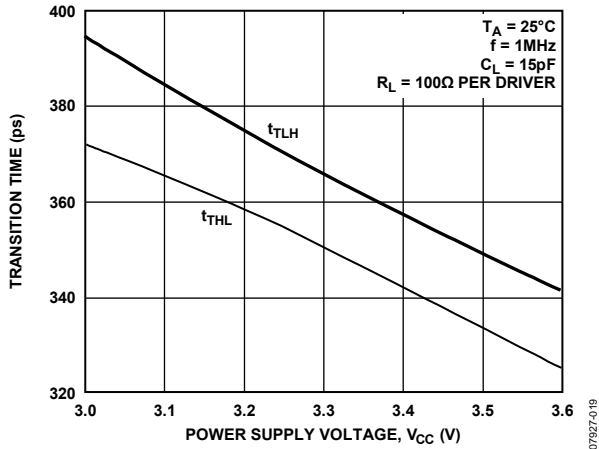

Figure 19. Transition Time vs. Power Supply Voltage

07927-019

## THEORY OF OPERATION

The ADN4663 is a dual line driver for low voltage differential signaling. It takes a single-ended 3 V logic signal and converts it to a differential current output. The data can then be transmitted for considerable distances, over media such as a twisted-pair cable or PCB backplane, to an LVDS receiver, where it develops a voltage across a terminating resistor,  $R_T$ . This resistor is chosen to match the characteristic impedance of the medium, typically around 100  $\Omega$ . The differential voltage is detected by the receiver and converted back into a single-ended logic signal.

When  $D_{INx}$  is high (Logic 1), current flows out of the  $D_{OUTx+}$  pin (current source) through  $R_T$  and back into the  $D_{OUTx-}$  pin (current sink). At the receiver, this current develops a positive differential voltage across  $R_T$  (with respect to the inverting input) and results in a Logic 1 at the receiver output. When  $D_{INx}$  is low,  $D_{OUTx+}$  sinks current and  $D_{OUTx-}$  sources current; a negative differential voltage across  $R_T$  results in a Logic 0 at the receiver output.

The output drive current is between  $\pm 2.5$  mA and  $\pm 4.5$  mA (typically  $\pm 3.55$  mA), developing between  $\pm 250$  mV and  $\pm 450$  mV across a 100  $\Omega$  termination resistor. The received voltage is centered around the receiver offset of 1.2 V. Therefore, the noninverting receiver input is typically  $(1.2 \text{ V} + [355 \text{ mV}/2]) = 1.377 \text{ V}$ , and the inverting receiver input is  $(1.2 \text{ V} - [355 \text{ mV}/2]) = 1.023 \text{ V}$  for Logic 1. For Logic 0, the inverting and noninverting output voltages are reversed. Note that because the differential voltage reverses polarity, the peak-to-peak voltage swing across  $R_T$  is twice the differential voltage.

Current mode drivers offer considerable advantages over voltage mode drivers such as RS-422 drivers. The operating current remains fairly constant with increased switching frequency, whereas that of voltage mode drivers increase exponentially in most cases. This is caused by the overlap as internal gates switch between high and low, which causes currents to flow from the device power supply to ground.

A current mode device simply reverses a constant current between its two outputs, with no significant overlap currents.

This is similar to emitter-coupled logic (ECL) and positive emitter-coupled logic (PECL), but without the high quiescent current of ECL and PECL.

## APPLICATIONS INFORMATION

Figure 21 shows a typical application for point-to-point data transmission using the ADN4663 as the driver and a LVDS receiver.

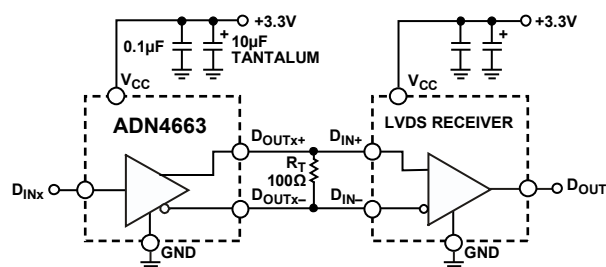
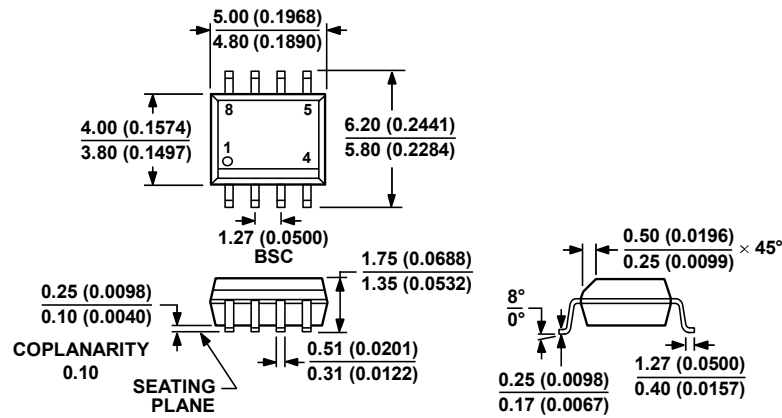

Figure 21. Typical Application Circuit

07987-021

## OUTLINE DIMENSIONS



COMPLIANT TO JEDEC STANDARDS MS-012-AA  
 CONTROLLING DIMENSIONS ARE IN MILLIMETERS; INCH DIMENSIONS  
 (IN PARENTHESES) ARE ROUNDED-OFF MILLIMETER EQUIVALENTS FOR  
 REFERENCE ONLY AND ARE NOT APPROPRIATE FOR USE IN DESIGN.

Figure 22. 8-Lead Standard Small Outline Package [SOIC(N)]  
 (R-8)

Dimensions shown in millimeters and (inches)

012407-A

## ORDERING GUIDE

Model	Temperature Range	Package Description	Package Option
ADN4663BRZ <sup>1</sup>	-40°C to +85°C	8-Lead Standard Small Outline Package [SOIC-N]	R-8
ADN4663BRZ-REEL <sup>1</sup>	-40°C to +85°C	8-Lead Standard Small Outline Package [SOIC-N]	R-8

<sup>1</sup> Z = RoHS Compliant Part.



Компания «ЭлектроПласт» предлагает заключение долгосрочных отношений при поставках импортных электронных компонентов на взаимовыгодных условиях!

Наши преимущества:

- Оперативные поставки широкого спектра электронных компонентов отечественного и импортного производства напрямую от производителей и с крупнейших мировых складов;
- Поставка более 17-ти миллионов наименований электронных компонентов;
- Поставка сложных, дефицитных, либо снятых с производства позиций;
- Оперативные сроки поставки под заказ (от 5 рабочих дней);
- Экспресс доставка в любую точку России;
- Техническая поддержка проекта, помощь в подборе аналогов, поставка прототипов;
- Система менеджмента качества сертифицирована по Международному стандарту ISO 9001;
- Лицензия ФСБ на осуществление работ с использованием сведений, составляющих государственную тайну;
- Поставка специализированных компонентов (Xilinx, Altera, Analog Devices, Intersil, Interpoint, Microsemi, Aeroflex, Peregrine, Syfer, Eurofarad, Texas Instrument, Miteq, Cobham, E2V, MA-COM, Hittite, Mini-Circuits, General Dynamics и др.);

Помимо этого, одним из направлений компании «ЭлектроПласт» является направление «Источники питания». Мы предлагаем Вам помощь Конструкторского отдела:

- Подбор оптимального решения, техническое обоснование при выборе компонента;
- Подбор аналогов;
- Консультации по применению компонента;
- Поставка образцов и прототипов;
- Техническая поддержка проекта;
- Защита от снятия компонента с производства.



#### Как с нами связаться

**Телефон:** 8 (812) 309 58 32 (многоканальный)

**Факс:** 8 (812) 320-02-42

**Электронная почта:** [org@eplast1.ru](mailto:org@eplast1.ru)

**Адрес:** 198099, г. Санкт-Петербург, ул. Калинина, дом 2, корпус 4, литера А.