

# NCP81071

## Dual 5 A High Speed Low-Side MOSFET Drivers with Enable

NCP81071 is a high speed dual low-side MOSFETs driver. It is capable of providing large peak currents into capacitive loads. This driver can deliver 5 A peak current at the Miller plateau region to help reduce the Miller effect during MOSFETs switching transition. This driver also provides enable functions to give users better control capability in different applications. ENA and ENB are implemented on pin 1 and pin 8 which were previously unused in the industry standard pin-out. They are internally pulled up to driver's input voltage for active high logic and can be left open for standard operations. This part is available in MSOP8-EP package, SOIC8 package and WDFN8 3 mm x 3 mm package.

### Features

- High Current Drive Capability  $\pm 5$  A
- TTL/CMOS Compatible Inputs Independent of Supply Voltage
- Industry Standard Pin-out
- Enable Functions for Each Driver
- 8 ns Typical Rise and 8 ns Typical Fall Times with 1.8 nF Load
- Typical Propagation Delay Times of 20 ns with Input Falling and 20 ns with Input Rising
- Input Voltage from 4.5 V to 20 V
- Dual Outputs can be Paralleled for Higher Drive Current
- These Devices are Pb-Free, Halogen Free/BFR Free and are RoHS Compliant

### Applications

- Server Power
- Telecommunication, Datacenter Power
- Synchronous Rectifier
- Switch Mode Power Supply
- DC/DC Converter
- Power Factor Correction
- Motor Drive
- Renewable Energy, Solar Inverter



ON Semiconductor®

[www.onsemi.com](http://www.onsemi.com)



SOIC-8  
D SUFFIX  
CASE 751



MSOP-8  
Z SUFFIX  
CASE 846AM



WDFN8  
MN SUFFIX  
CASE 511CD

### MARKING DIAGRAMS

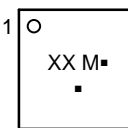
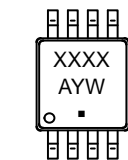
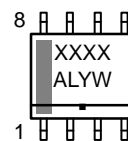

XX = Specific Device Code  
A = Assembly Location  
L = Wafer Lot  
Y = Year  
W = Work Week  
M = Date Code  
▪ = Pb-Free Package

(Note: Microdot may be in either location)

### PIN CONNECTIONS

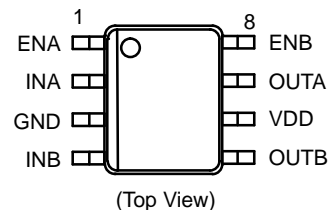

### ORDERING INFORMATION

See detailed ordering and shipping information in the package dimensions section on page 2 of this data sheet.

# NCP81071

## ORDERING INFORMATION

Part Number	Package Type	Tape and Reel	Output Configuration	Temperature Range (°C)
NCP81071ADR2G	SOIC-8	2500	dual inverting	-40 to +140
NCP81071BDR2G	SOIC-8	2500	dual non inverting	
NCP81071CDR2G	SOIC-8	2500	One inverting one non inverting	
NCP81071AZR2G	MSOP8 EP	3000	dual inverting	
NCP81071BZR2G	MSOP8 EP	3000	dual non inverting	
NCP81071CZR2G	MSOP8 EP	3000	One inverting one non inverting	
NCP81071AMNTXG	WDFN8 3x3	3000	dual inverting	
NCP81071BMNTXG	WDFN8 3x3	3000	dual non inverting	
NCP81071CMNTXG	WDFN8 3x3	3000	One inverting one non inverting	

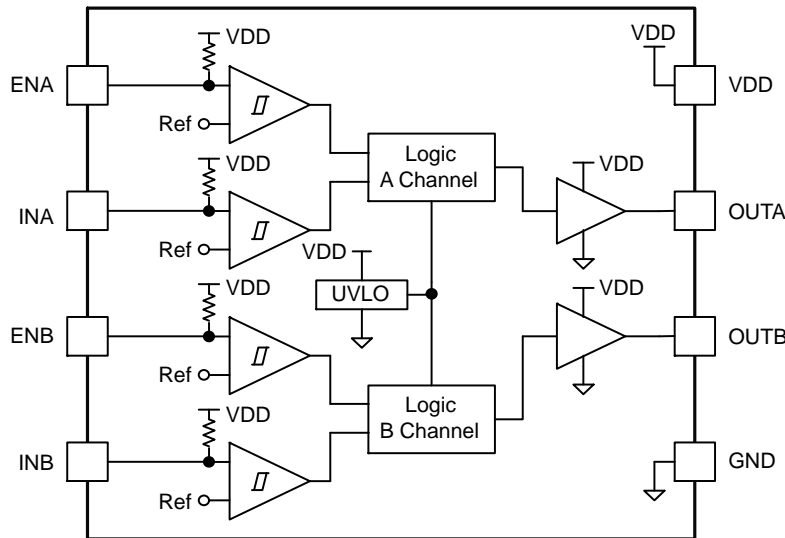

Figure 1. NCP81071 Dual Non-inverting Block Diagram

Table 1. PIN DESCRIPTION

Pin No.	Symbol	Description
1	ENA	Enable input for the driver channel A with logic compatible threshold and hysteresis. This pin is used to enable and disable the driver output. It is internally pulled up to VDD with a 200 kΩ resistor for active high operation. The output of the pin when the device is disabled will be always low.
2	INA	Input of driver channel A which has logic compatible threshold and hysteresis. If not used, this pin should be connected to either VDD or GND. It should not be left unconnected.
3	GND	Common ground. This ground should be connected very closely to the source of the power MOSFET.
4	INB	Input of driver channel B which has logic compatible threshold and hysteresis. If not used, this pin should be connected to either VDD or GND. It should not be left unconnected.
5	OUTB	Output of driver channel B. The driver is able to provide 5 A drive current to the gate of the power MOSFET.
6	VDD	Supply voltage. Use this pin to connect the input power for the driver device.
7	OUTA	Output of driver channel A. The driver is able to provide 5 A drive current to the gate of the power MOSFET.
8	ENB	Enable input for the driver channel B with logic compatible threshold and hysteresis. This pin is used to enable and disable the driver output. It is internally pulled up to VDD with a 200 kΩ resistor for active high operation. The output of the pin when the device is disabled will be always low.

# NCP81071

## TYPICAL APPLICATION CIRCUIT

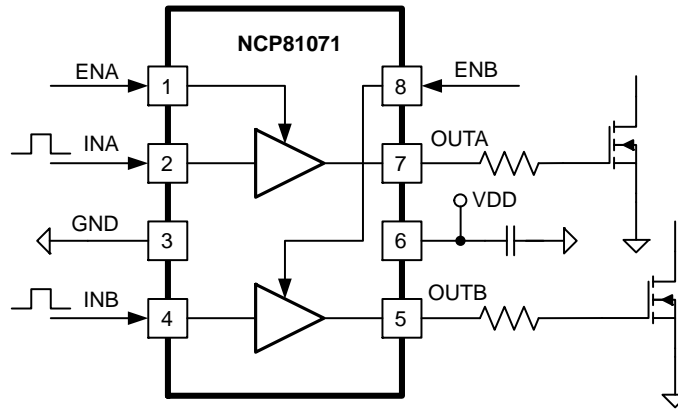

**Table 2. ABSOLUTE MAXIMUM RATINGS**

		Value		Unit
		Min	Max	
Supply Voltage	VDD	-0.3	24	V
Output Current (DC)	I <sub>out_dc</sub>	0.3		A
Output Current (Pulse < 0.5 μs)	I <sub>out_pulse</sub>	6		A
Input Voltage	INA, INB	-6	VDD+0.3	V
Enable Voltage	ENA, ENB	-0.3	VDD+0.3	
Output Voltage	OUTA, OUTB	-0.3	VDD+0.3	V
Output Voltage (Pulse < 0.5 μs)	OUTA, OUTB	-1.0	VDD+1.0	V
Junction Operation Temperature	T <sub>J</sub>	-40	150	°C
Storage Temperature	T <sub>stg</sub>	-65	160	
Electrostatic Discharge	Human body model, HBM	4000		V
	Charge device model, CDM	1000		
OUTA OUTB Latch-up Protection		500		mA

Stresses exceeding those listed in the Maximum Ratings table may damage the device. If any of these limits are exceeded, device functionality should not be assumed, damage may occur and reliability may be affected.

**Table 3. RECOMMENDED OPERATING CONDITIONS**

Parameter	Rating	Unit
VDD supply Voltage	4.5 to 20	V
INA, INB input voltage	-5 to VDD	V
ENA, ENB input voltage	0 to VDD	V
Junction Temperature Range	-40 to +140	°C

Functional operation above the stresses listed in the Recommended Operating Ranges is not implied. Extended exposure to stresses beyond the Recommended Operating Ranges limits may affect device reliability.

**Table 4. THERMAL INFORMATION**

Package	θ <sub>JA</sub> (°C/W)	θ <sub>JC</sub> (°C/W)
SOIC-8	115	50
MSOP-8 EP	39	4.7
WDFN8 3x3	39	4.7

# NCP81071

Table 5. INPUT/OUTPUT TABLE

ENA	ENB	INA	INB	NCP81071A		NCP81071B		NCP81071C	
				OUTA	OUTB	OUTA	OUTB	OUTA	OUTB
H	H	L	L	H	H	L	L	H	L
H	H	L	H	H	L	L	H	H	H
H	H	H	L	L	H	H	L	L	L
H	H	H	H	L	L	H	H	L	H
L	L	Any	Any	L	L	L	L	L	L
Any	Any	x (Note 1)	x (Note 1)	L	L	L	L	L	L
x (Note 1)	x (Note 1)	L	L	H	H	L	L	H	L
x (Note 1)	x (Note 1)	L	H	H	L	L	H	H	H
x (Note 1)	x (Note 1)	H	L	L	H	H	L	L	L
x (Note 1)	x (Note 1)	H	H	L	L	H	H	L	H

1. Floating condition, internal resistive pull up or pull down configures output condition

## PRODUCT MATRIX

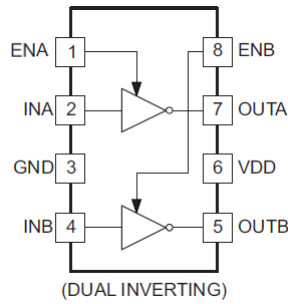

NCP81071A

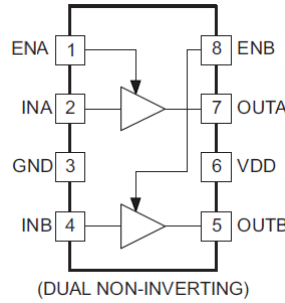

NCP81071B

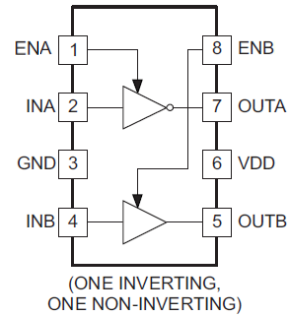

NCP81071C

# NCP81071

**Table 6. ELECTRICAL CHARACTERISTICS**

(Typical values:  $V_{DD} = 12\text{ V}$ ,  $1\ \mu\text{F}$  from  $V_{DD}$  to GND,  $T_A = T_J = -40^\circ\text{C}$  to  $140^\circ\text{C}$ , typical at  $T_{AMB} = 25^\circ\text{C}$ , unless otherwise specified)

Parameter	Symbol	Test Conditions	Min	Typ	Max	Units
<b>SUPPLY VOLTAGE</b>						
VDD Under Voltage Lockout (rising)	$V_{CCR}$	VDD rising	3.5	4.0	4.5	V
VDD Under Voltage Lockout (hysteresis)	$V_{CCH}$			400		mV
Operating Current (no switching)	$I_{DD}$	INA = 0, INB = 5 V, ENA = ENB = 0 INA = 5 V, INB = 0, ENA = ENB = 0 INA = 0, INB = 5 V, ENA = ENB = 5 V INA = 5 V, INB = 0, ENA = ENB = 5 V		1.4	3	mA
VDD Under Voltage Lockout to Output Delay (Note 2)		VDD rising		10		$\mu\text{s}$

## INPUTS

High Threshold	$V_{thH}$	Input rising from logic low	1.8	2.0	2.2	V
Low Threshold	$V_{thL}$	Input falling from logic high	0.8	1.0	1.2	V
INA, INB Pull-Up Resistance		OUTA = OUTB = Inverter Configuration		200		k $\Omega$
INA, INB Pull-Down Resistance		OUTA = OUTB = Buffer Configuration		200		k $\Omega$

## OUTPUTS

Output Resistance High	$R_{OH}$	IOU <sub>T</sub> = -10 mA		0.8	2	$\Omega$
Output Resistance Low	$R_{OL}$	IOU <sub>T</sub> = +10 mA		0.8	2	$\Omega$
Peak Source Current (Note 3)	$I_{Source}$	OUTA/OUTB = GND 200 ns Pulse		5		A
Miller Plateau Source Current (Note 3)	$I_{Source}$	OUTA/OUTB = 5.0 V 200 ns Pulse		4.5		A
Peak Sink Current (Note 3)	$I_{Sink}$	OUTA/OUTB = VDD 200 ns Pulse		5		A
Miller Plateau Sink Current (Note 3)	$I_{Sink}$	OUTA/OUTB = 5.0 V 200 ns Pulse		3.5		A

## ENABLE

High-Level Input Voltage	$V_{IN\_H}$	Low to High Transition	1.8	2.0	2.2	V
Low-Level Input Voltage	$V_{IN\_L}$	High to Low Transition	0.8	1.0	1.2	V
ENA, ENB pull-up resistance				200		k $\Omega$
Propagation Delay Time (EN to OUT) (Note 4)	$t_{d3}$	$C_{Load} = 1.8\text{ nF}$		20	35	ns
Propagation Delay Time (EN to OUT) (Note 4)	$t_{d4}$	$C_{Load} = 1.8\text{ nF}$		20	35	ns

## SWITCHING CHARACTERISTICS

Propagation Delay Time Low to High, IN Rising (IN to OUT) (Note 4)	$t_{d1}$	$C_{Load} = 1.8\text{ nF}$		20	35	ns
Propagation Delay Time High to Low, IN Falling (IN to OUT) (Note 4)	$t_{d2}$	$C_{Load} = 1.8\text{ nF}$		20	35	ns
Rise Time (Note 4)	$t_r$	$C_{Load} = 1.8\text{ nF}$		8	15	ns
Fall Time (Note 4)	$t_f$	$C_{Load} = 1.8\text{ nF}$		8	15	ns
Delay Matching between 2 Channels (Note 5)	$t_m$	INA = INB, OUTA and OUTB at 50% Transition Point		1	4	ns

Product parametric performance is indicated in the Electrical Characteristics for the listed test conditions, unless otherwise noted. Product performance may not be indicated by the Electrical Characteristics if operated under different conditions.

- Guaranteed by design.
- Not production tested, guaranteed by design and statistical analysis.
- See timing diagrams in Figure 2, Figure 3, Figure 4 and Figure 5.
- Guaranteed by characterization.

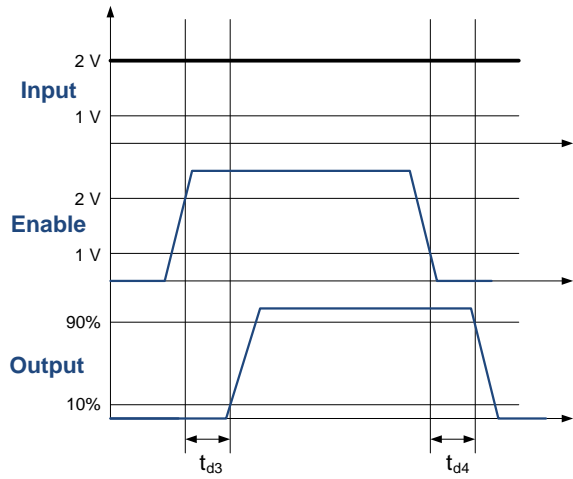

Figure 2. Enable Function for Non-inverting Input Driver Operation

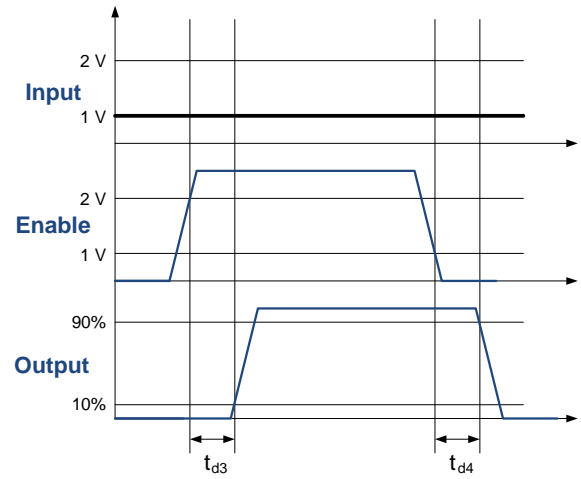

Figure 3. Enable Function for Inverting Input Driver Operation

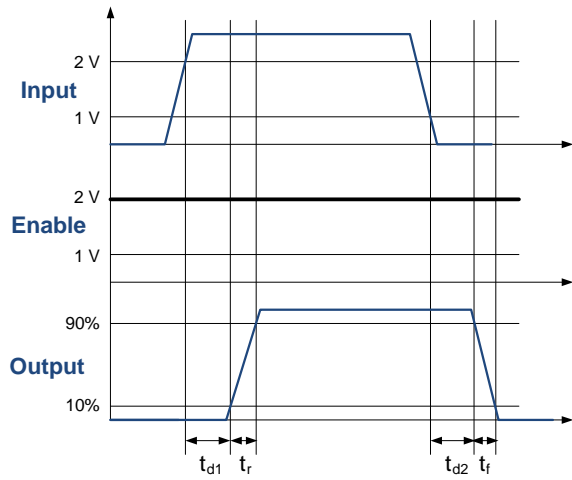

Figure 4. Non-inverting Input Driver Operation

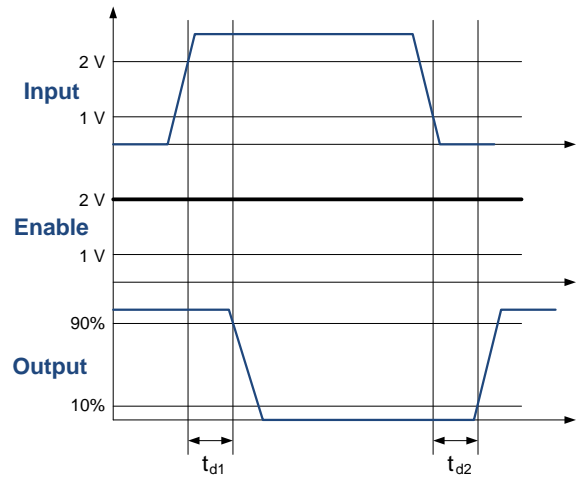

Figure 5. Inverting Input Driver Operation

TYPICAL CHARACTERISTICS

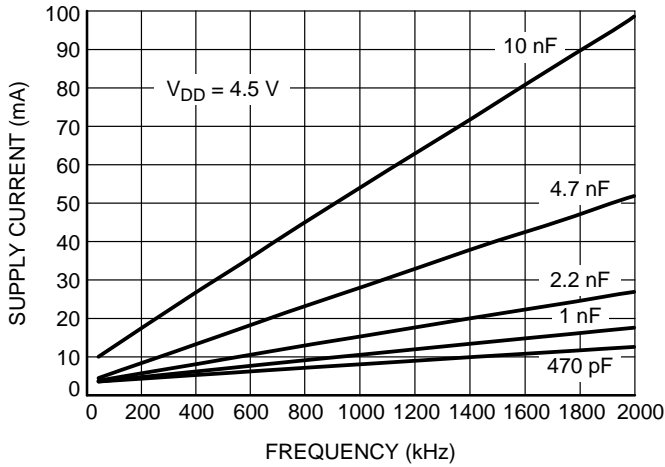

Figure 6. Supply Current vs. Switching Frequency ( $V_{DD} = 4.5\text{ V}$ )

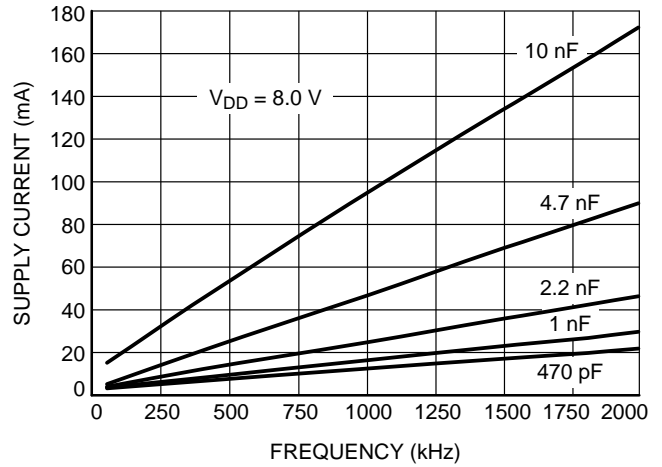

Figure 7. Supply Current vs. Switching Frequency ( $V_{DD} = 8.0\text{ V}$ )

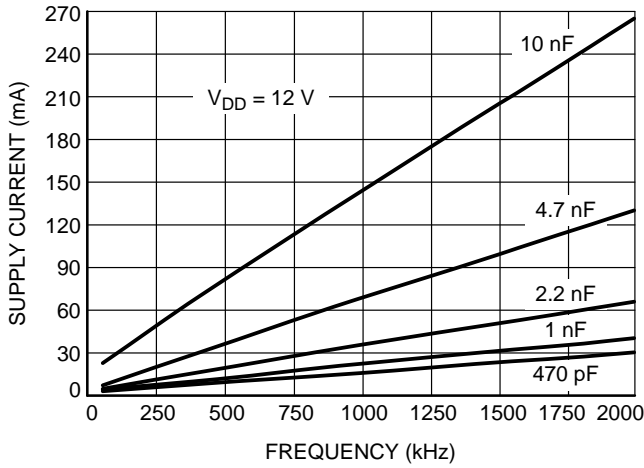

Figure 8. Supply Current vs. Switching Frequency ( $V_{DD} = 12\text{ V}$ )

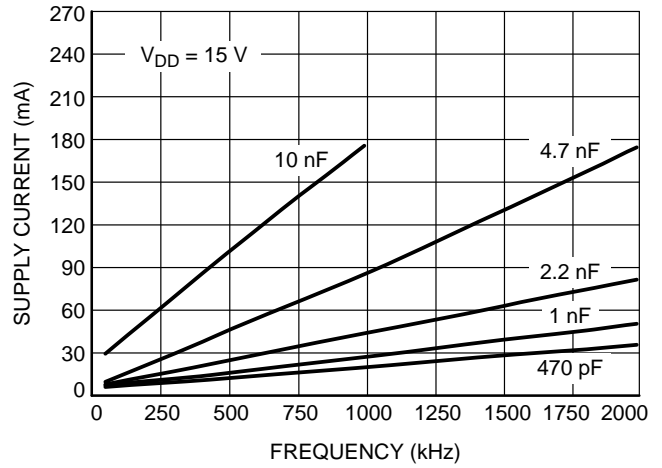

Figure 9. Supply Current vs. Switching Frequency ( $V_{DD} = 15\text{ V}$ )

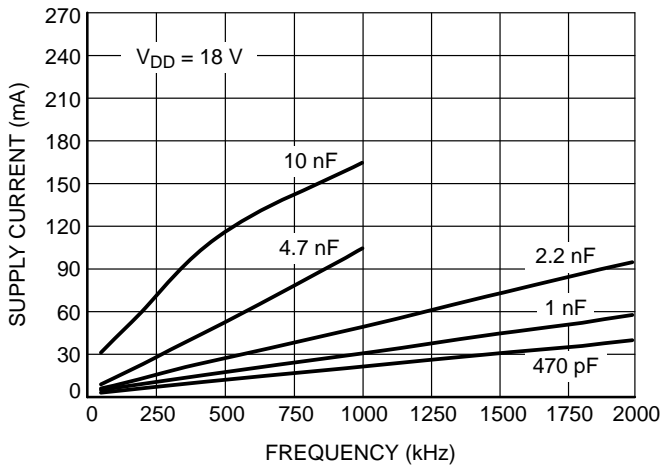

Figure 10. Supply Current vs. Switching Frequency ( $V_{DD} = 18\text{ V}$ )

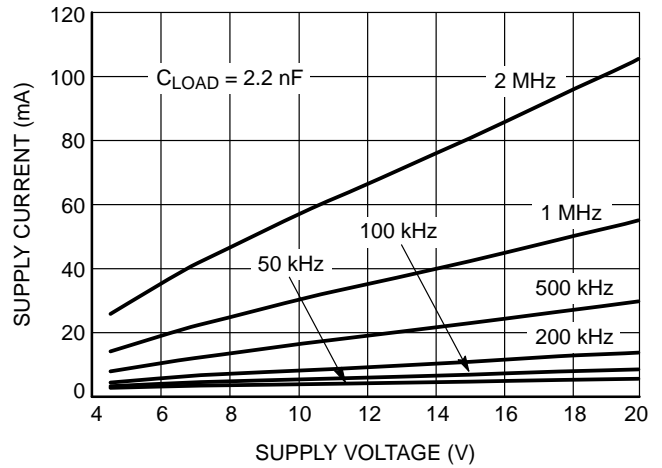

Figure 11. Supply Current vs. Supply Voltage ( $C_{LOAD} = 2.2\text{ nF}$ )

# NCP81071

## TYPICAL CHARACTERISTICS

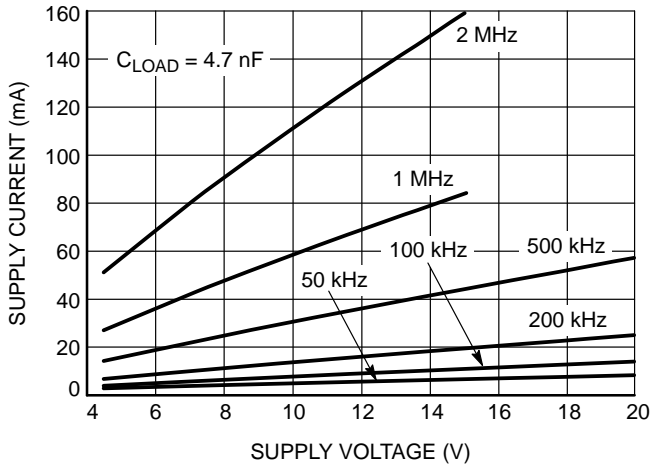

Figure 12. Supply Current vs. Supply Voltage ( $C_{LOAD} = 4.7 \text{ nF}$ )

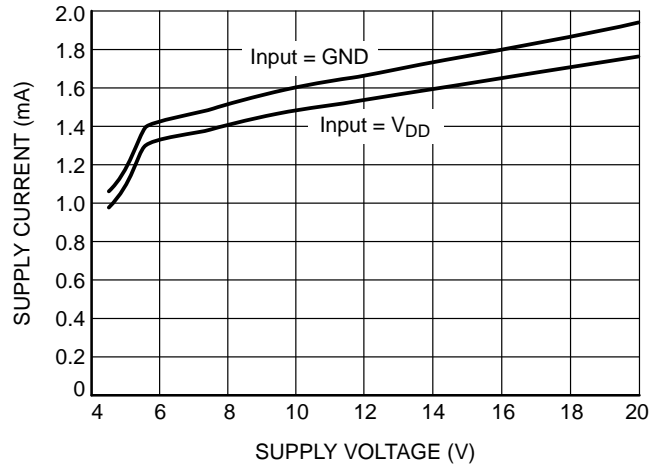

Figure 13. Supply Current vs. Supply Voltage (NCP81071A)

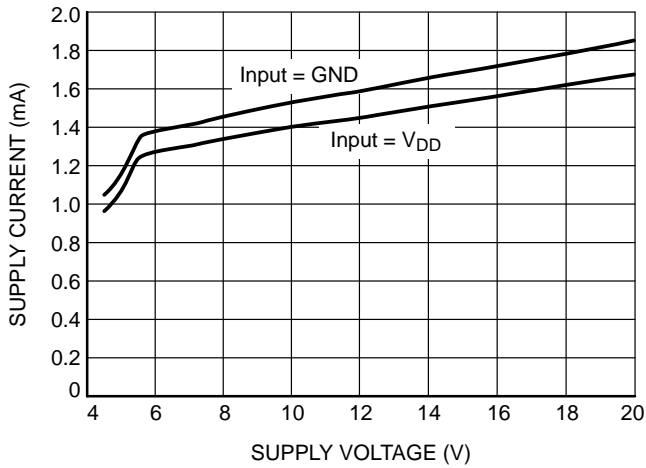

Figure 14. Supply Current vs. Supply Voltage (NCP81071B)

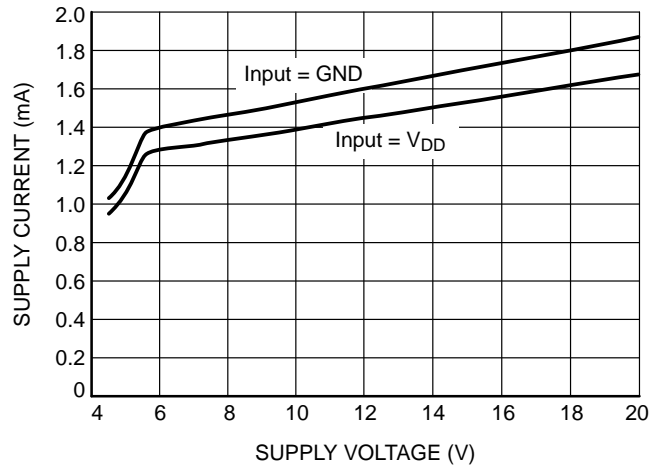

Figure 15. Supply Current vs. Supply Voltage (NCP81071C)

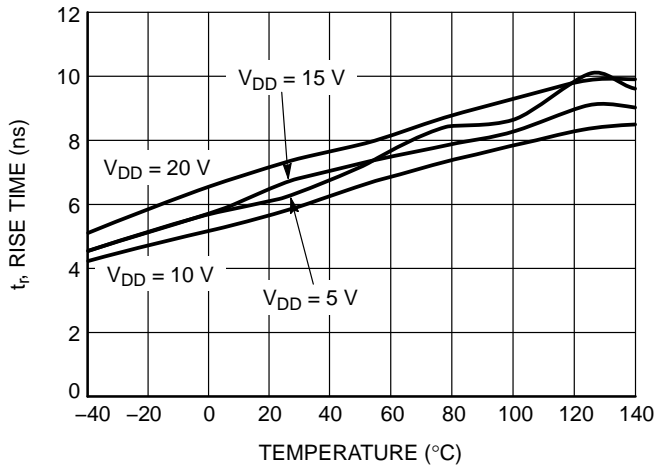

Figure 16. Rise Time vs. Temperature

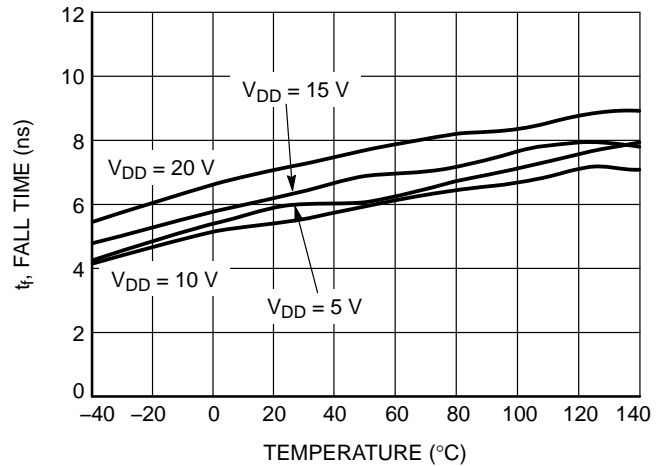

Figure 17. Fall Time vs. Temperature



# NCP81071

## TYPICAL CHARACTERISTICS

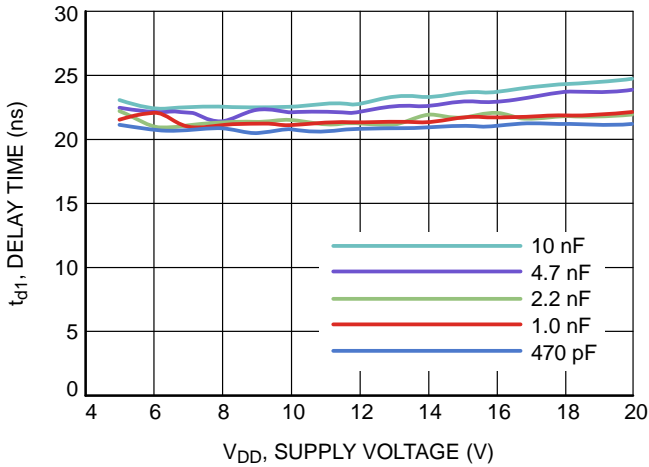

Figure 18. Propagation Delay  $t_{d1}$  vs. Supply Voltage

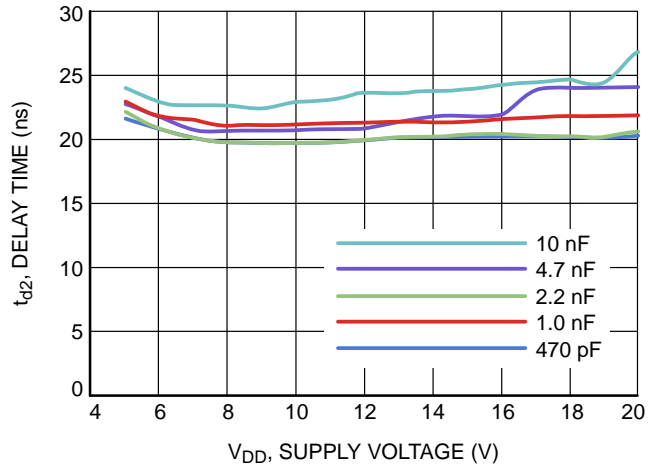

Figure 19. Propagation Delay  $t_{d2}$  vs. Supply Voltage

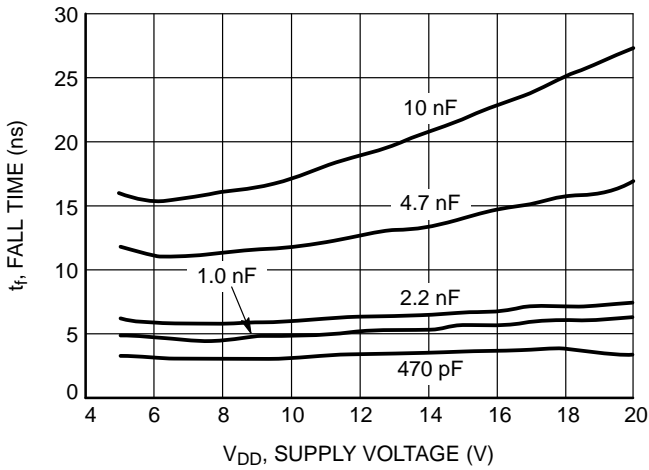

Figure 20. Fall Time  $t_f$  vs. Supply Voltage

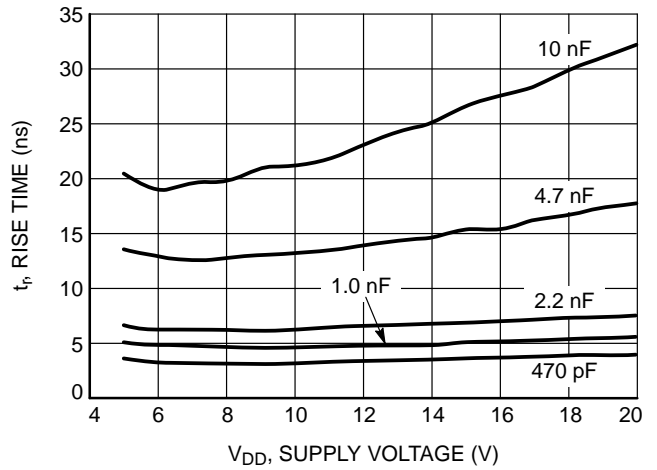

Figure 21. Rise Time  $t_r$  vs. Supply Voltage

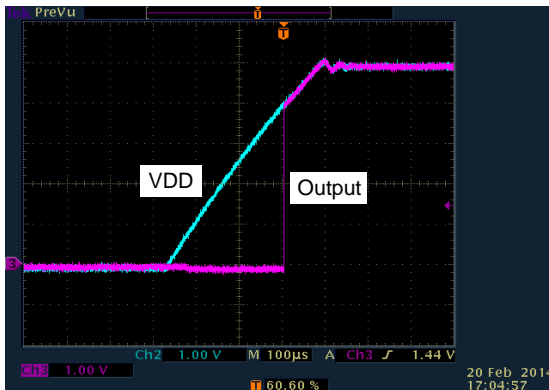

Figure 22. Output Behavior vs. Supply Voltage NCP81071A (Inverting) 10 nF between Output and GND, INA = GND, ENA = VDD

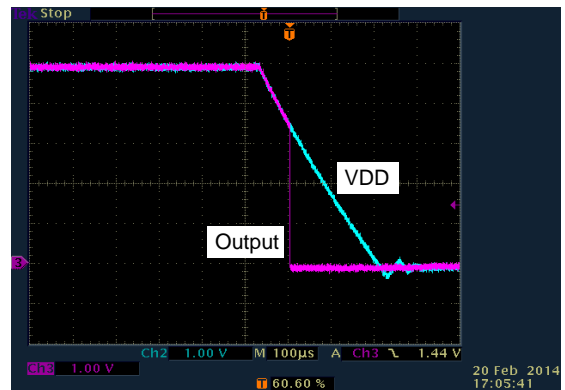

Figure 23. Output Behavior vs. Supply Voltage NCP81071A (Inverting) 10 nF between Output and GND, INA = GND, ENA = VDD

TYPICAL CHARACTERISTICS

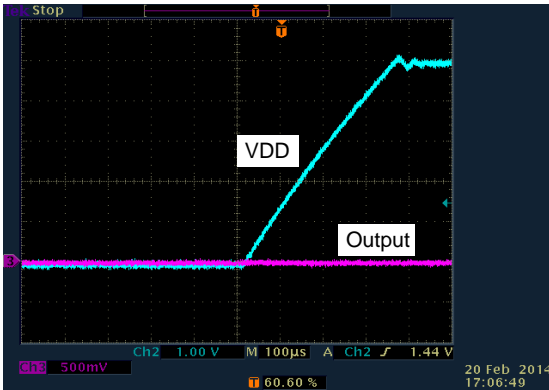

Figure 24. Output Behavior vs. Supply Voltage NCP81071A (Inverting) 10 nF between Output and GND, INA = VDD, ENA = VDD

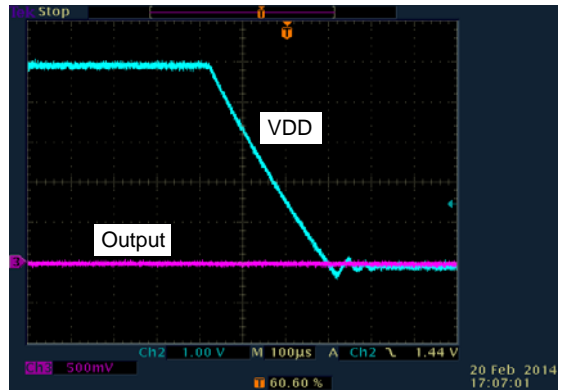

Figure 25. Output Behavior vs. Supply Voltage NCP81071A (Inverting) 10 nF between Output and GND, INA = VDD, ENA = VDD

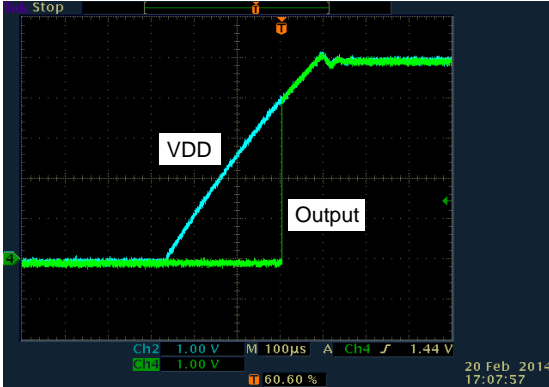

Figure 26. Output Behavior vs. Supply Voltage NCP81071B (Non-Inverting) 10 nF between Output and GND, INA = VDD, ENA = VDD

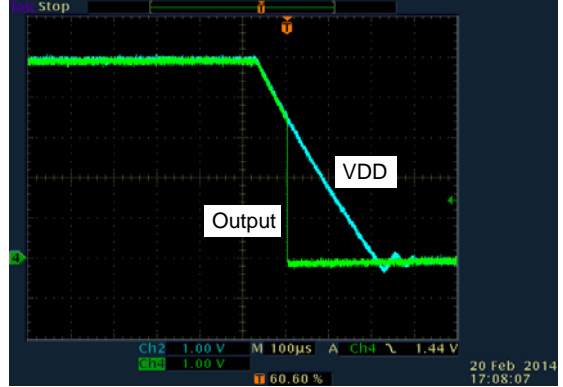

Figure 27. Output Behavior vs. Supply Voltage NCP81071B (Non-Inverting) 10 nF between Output and GND, INA = VDD, ENA = VDD

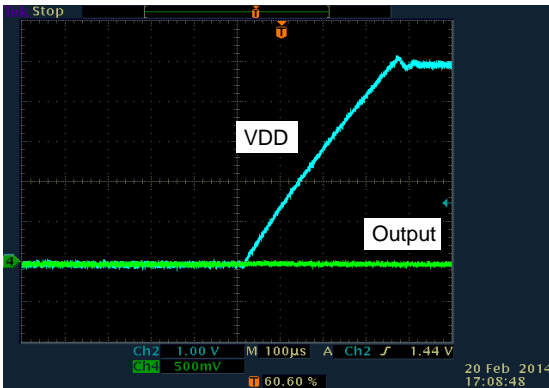

Figure 28. Output Behavior vs. Supply Voltage NCP81071B (Non-Inverting) 10 nF between Output and GND, INA = GND, ENA = VDD

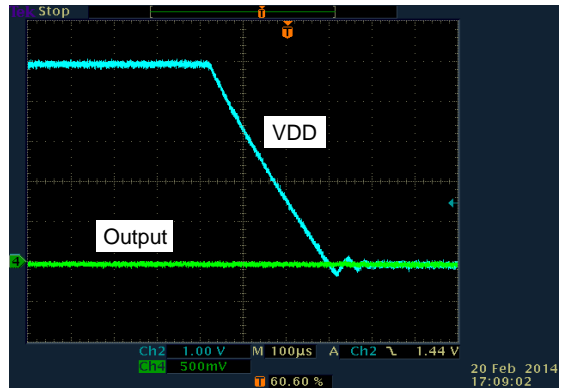

Figure 29. Output Behavior vs. Supply Voltage NCP81071B (Non-Inverting) 10 nF between Output and GND, INA = GND, ENA = VDD

# NCP81071

## LAYOUT GUIDELINES

The switching performance of NCP81071 highly depends on the design of PCB board. The following layout design guidelines are recommended when designing boards using these high speed drivers.

Place the driver as close as possible to the driven MOSFET.

Place the bypass capacitor between VDD and GND as close as possible to the driver to improve the noise filtering. It is preferred to use low inductance components such as chip capacitor and chip resistor. If vias are used, connect several paralleled vias to reduce the inductance of the vias.

Minimize the turn-on/sourcing current and turn-off/sinking current paths in order to minimize stray inductance. Otherwise high di/dt established in these loops with stray inductance can induce significant voltage spikes on the output of the driver and MOSFET Gate terminal.

Keep power loops as short as possible by paralleling the source and return traces (flux cancellation).

Keep low level signal lines away from high level power lines with a lot of switching noise.

Place a ground plane for better noise shielding. Beside noise shielding, ground plane is also useful for heat dissipation.

NCP81071 DFN and MSOP package have thermal pad for: 1) quiet GND for all the driver circuits; 2) heat sink for the driver. This pad must be connected to a ground plane and no switching currents from the driven MOSFET should pass through the ground plane under the driver. To maximize the heatsinking capability, it is recommended several ground layers are added to connect to the ground plane and thermal pad. A via array within the area of package can conduct the heat from the package to the ground layers and the whole PCB board. The number of vias and the size of ground plane are determined by the power dissipation of NCP81071 (VDD voltage, switching frequency and load condition), the air flow condition and its maximum junction temperature.

# NCP81071

## PACKAGE DIMENSIONS

SOIC-8 NB  
CASE 751-07  
ISSUE AK

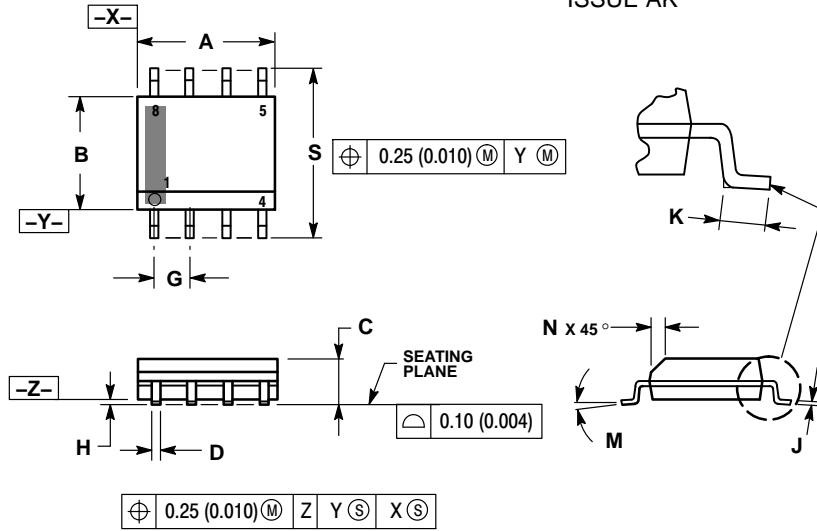

NOTES:

1. DIMENSIONING AND TOLERANCING PER ANSI Y14.5M, 1982.
2. CONTROLLING DIMENSION: MILLIMETER.
3. DIMENSION A AND B DO NOT INCLUDE MOLD PROTRUSION.
4. MAXIMUM MOLD PROTRUSION 0.15 (0.006) PER SIDE.
5. DIMENSION D DOES NOT INCLUDE DAMBAR PROTRUSION. ALLOWABLE DAMBAR PROTRUSION SHALL BE 0.127 (0.005) TOTAL IN EXCESS OF THE D DIMENSION AT MAXIMUM MATERIAL CONDITION.
6. 751-01 THRU 751-06 ARE OBSOLETE. NEW STANDARD IS 751-07.

DIM	MILLIMETERS		INCHES	
	MIN	MAX	MIN	MAX
A	4.80	5.00	0.189	0.197
B	3.80	4.00	0.150	0.157
C	1.35	1.75	0.053	0.069
D	0.33	0.51	0.013	0.020
G	1.27 BSC		0.050 BSC	
H	0.10	0.25	0.004	0.010
J	0.19	0.25	0.007	0.010
K	0.40	1.27	0.016	0.050
M	0°	8°	0°	8°
N	0.25	0.50	0.010	0.020
S	5.80	6.20	0.228	0.244

### SOLDERING FOOTPRINT\*

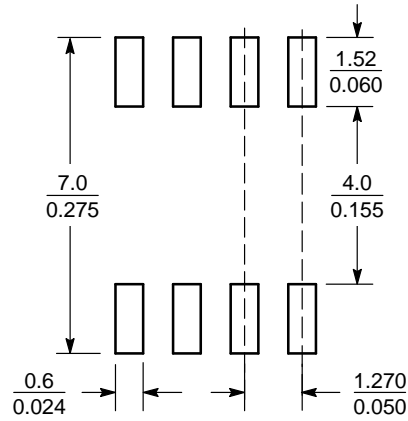

SCALE 6:1 ( $\frac{\text{mm}}{\text{inches}}$ )

\*For additional information on our Pb-Free strategy and soldering details, please download the ON Semiconductor Soldering and Mounting Techniques Reference Manual, SOLDERRM/D.

# NCP81071

## PACKAGE DIMENSIONS

### MSOP8 EP, 3x3 CASE 846AM ISSUE O

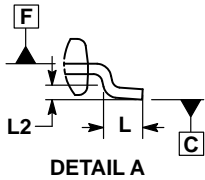
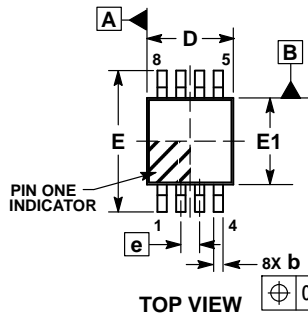

#### NOTES:

1. DIMENSIONS AND TOLERANCING PER ASME Y14.5M, 1994.
2. CONTROLLING DIMENSIONS: MILLIMETERS.
3. DIMENSION b DOES NOT INCLUDE DAMBAR PROTRUSION. ALLOWABLE DAMBAR PROTRUSION SHALL BE 0.10 MM IN EXCESS OF MAXIMUM MATERIAL CONDITION.
4. DIMENSION D DOES NOT INCLUDE MOLD FLASH, PROTRUSIONS, OR GATE BURRS. MOLD FLASH, PROTRUSIONS, OR GATE BURRS SHALL NOT EXCEED 0.15 MM PER SIDE. DIMENSION E DOES NOT INCLUDE INTERLEAD FLASH OR PROTRUSION. INTERLEAD FLASH OR PROTRUSION SHALL NOT EXCEED 0.25 MM PER SIDE. DIMENSIONS D AND E ARE DETERMINED AT DATUM F.
5. DATUMS A AND B TO BE DETERMINED AT DATUM F.
6. A1 IS DEFINED AS THE VERTICAL DISTANCE FROM THE SEATING PLANE TO THE LOWEST POINT ON THE PACKAGE BODY.

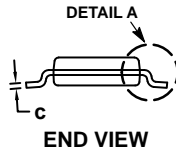
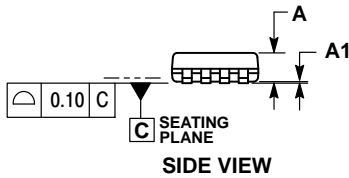

DIM	MILLIMETERS	
	MIN	MAX
A	---	1.10
A1	0.05	0.15
b	0.25	0.40
c	0.13	0.23
D	2.90	3.10
D2	1.78	REF
E	4.75	5.05
E1	2.90	3.10
E2	1.42	REF
e	0.65	BSC
L	0.40	0.70
L2	0.254	BSC

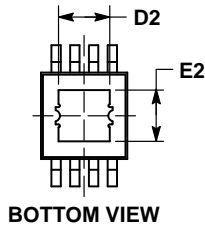

#### RECOMMENDED SOLDERING FOOTPRINT\*

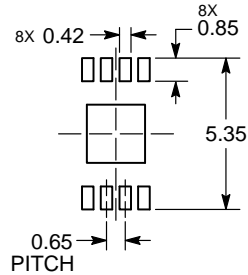

DIMENSIONS: MILLIMETERS

\*For additional information on our Pb-Free strategy and soldering details, please download the ON Semiconductor Soldering and Mounting Techniques Reference Manual, SOLDERRM/D.

# NCP81071

## PACKAGE DIMENSIONS

WDFN8 3x3, 0.65P  
CASE 511CD  
ISSUE O

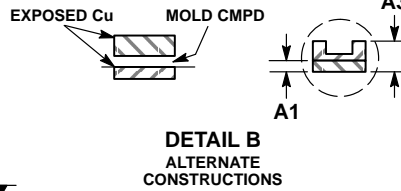
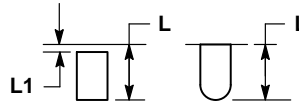
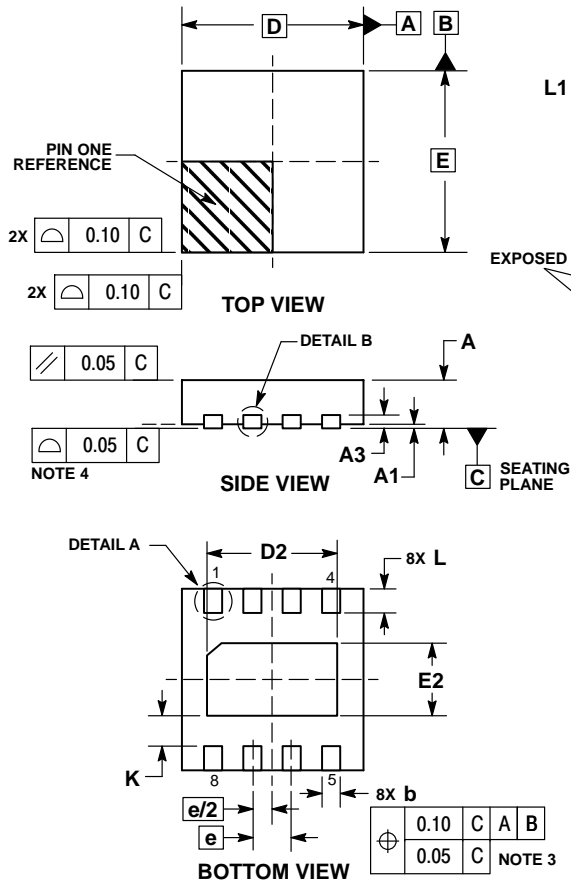

**NOTES:**

1. DIMENSIONING AND TOLERANCING PER ASME Y14.5M, 1994.
2. CONTROLLING DIMENSION: MILLIMETERS.
3. DIMENSION b APPLIES TO PLATED TERMINAL AND IS MEASURED BETWEEN 0.15 AND 0.30 MM FROM TERMINAL TIP.
4. COPLANARITY APPLIES TO THE EXPOSED PAD AS WELL AS THE TERMINALS.

DIM	MILLIMETERS	
	MIN	MAX
A	0.70	0.80
A1	0.00	0.05
A3	0.20	REF
b	0.25	0.35
D	3.00	BSC
D2	2.05	2.25
E	3.00	BSC
E2	1.10	1.30
e	0.65	BSC
K	0.20	---
L	0.30	0.50
L1	0.00	0.15

### RECOMMENDED SOLDERING FOOTPRINT\*

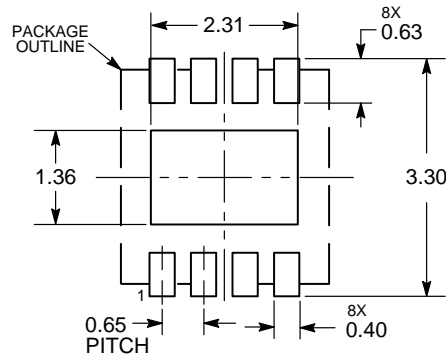

DIMENSIONS: MILLIMETERS

\*For additional information on our Pb-Free strategy and soldering details, please download the ON Semiconductor Soldering and Mounting Techniques Reference Manual, SOLDERRM/D.

ON Semiconductor and the are registered trademarks of Semiconductor Components Industries, LLC (SCILLC) or its subsidiaries in the United States and/or other countries. SCILLC owns the rights to a number of patents, trademarks, copyrights, trade secrets, and other intellectual property. A listing of SCILLC's product/patent coverage may be accessed at [www.onsemi.com/site/pdf/Patent-Marketing.pdf](http://www.onsemi.com/site/pdf/Patent-Marketing.pdf). SCILLC reserves the right to make changes without further notice to any products herein. SCILLC makes no warranty, representation or guarantee regarding the suitability of its products for any particular purpose, nor does SCILLC assume any liability arising out of the application or use of any product or circuit, and specifically disclaims any and all liability, including without limitation special, consequential or incidental damages. "Typical" parameters which may be provided in SCILLC data sheets and/or specifications can and do vary in different applications and actual performance may vary over time. All operating parameters, including "Typicals" must be validated for each customer application by customer's technical experts. SCILLC does not convey any license under its patent rights nor the rights of others. SCILLC products are not designed, intended, or authorized for use as components in systems intended for surgical implant into the body, or other applications intended to support or sustain life, or for any other application in which the failure of the SCILLC product could create a situation where personal injury or death may occur. Should Buyer purchase or use SCILLC products for any such unintended or unauthorized application, Buyer shall indemnify and hold SCILLC and its officers, employees, subsidiaries, affiliates, and distributors harmless against all claims, costs, damages, and expenses, and reasonable attorney fees arising out of, directly or indirectly, any claim of personal injury or death associated with such unintended or unauthorized use, even if such claim alleges that SCILLC was negligent regarding the design or manufacture of the part. SCILLC is an Equal Opportunity/Affirmative Action Employer. This literature is subject to all applicable copyright laws and is not for resale in any manner.

### PUBLICATION ORDERING INFORMATION

**LITERATURE FULFILLMENT:**

Literature Distribution Center for ON Semiconductor  
P.O. Box 5163, Denver, Colorado 80217 USA  
Phone: 303-675-2175 or 800-344-3860 Toll Free USA/Canada  
Fax: 303-675-2176 or 800-344-3867 Toll Free USA/Canada  
Email: [orderlit@onsemi.com](mailto:orderlit@onsemi.com)

**N. American Technical Support:** 800-282-9855 Toll Free  
USA/Canada  
**Europe, Middle East and Africa Technical Support:**  
Phone: 421 33 790 2910  
**Japan Customer Focus Center**  
Phone: 81-3-5817-1050

**ON Semiconductor Website:** [www.onsemi.com](http://www.onsemi.com)

**Order Literature:** <http://www.onsemi.com/orderlit>

For additional information, please contact your local Sales Representative



Компания «ЭлектроПласт» предлагает заключение долгосрочных отношений при поставках импортных электронных компонентов на взаимовыгодных условиях!

Наши преимущества:

- Оперативные поставки широкого спектра электронных компонентов отечественного и импортного производства напрямую от производителей и с крупнейших мировых складов;
- Поставка более 17-ти миллионов наименований электронных компонентов;
- Поставка сложных, дефицитных, либо снятых с производства позиций;
- Оперативные сроки поставки под заказ (от 5 рабочих дней);
- Экспресс доставка в любую точку России;
- Техническая поддержка проекта, помощь в подборе аналогов, поставка прототипов;
- Система менеджмента качества сертифицирована по Международному стандарту ISO 9001;
- Лицензия ФСБ на осуществление работ с использованием сведений, составляющих государственную тайну;
- Поставка специализированных компонентов (Xilinx, Altera, Analog Devices, Intersil, Interpoint, Microsemi, Aeroflex, Peregrine, Syfer, Eurofarad, Texas Instrument, Miteq, Cobham, E2V, MA-COM, Hittite, Mini-Circuits, General Dynamics и др.);

Помимо этого, одним из направлений компании «ЭлектроПласт» является направление «Источники питания». Мы предлагаем Вам помощь Конструкторского отдела:

- Подбор оптимального решения, техническое обоснование при выборе компонента;
- Подбор аналогов;
- Консультации по применению компонента;
- Поставка образцов и прототипов;
- Техническая поддержка проекта;
- Защита от снятия компонента с производства.



#### Как с нами связаться

**Телефон:** 8 (812) 309 58 32 (многоканальный)

**Факс:** 8 (812) 320-02-42

**Электронная почта:** [org@eplast1.ru](mailto:org@eplast1.ru)

**Адрес:** 198099, г. Санкт-Петербург, ул. Калинина, дом 2, корпус 4, литера А.