



STGW40N120KD STGWA40N120KD

40 A, 1200 V short circuit rugged IGBT with Ultrafast diode

Features

- Low on-losses
- High current capability
- Low gate charge
- Short circuit withstand time 10 μ s
- IGBT co-packaged with Ultrafast free-wheeling diode

Applications

- Motor control

Description

This high voltage and short-circuit rugged IGBT utilizes the advanced PowerMESH™ process resulting in an excellent trade-off between switching performance and low ON-state behavior.

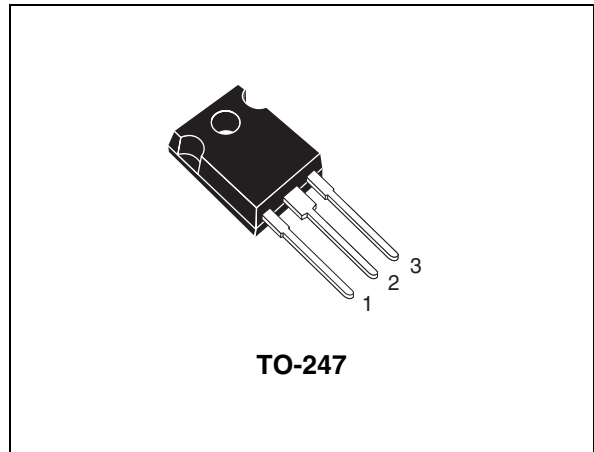

Figure 1. Internal schematic diagram

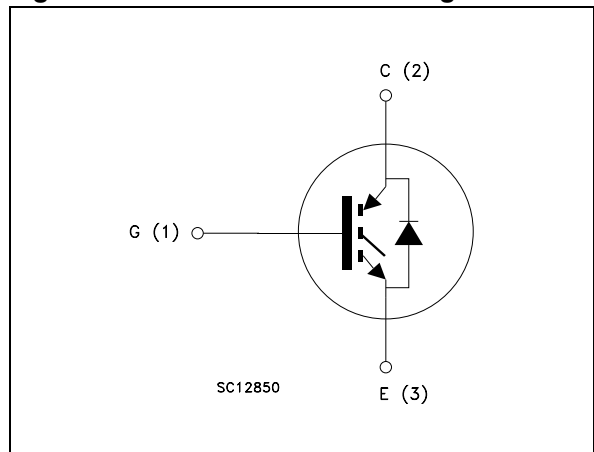

Table 1. Device summary

Order codes	Markings	Package	Packaging
STGW40N120KD	GW40N120KD	TO-247	Tube
STGWA40N120KD	GWA40N120KD	TO-247 long leads	Tube

Contents

1	Electrical ratings	3
2	Electrical characteristics	4
	2.1 Electrical characteristics (curves)	6
3	Test circuits	9
4	Package mechanical data	10
5	Revision history	14

1 Electrical ratings

Table 2. Absolute maximum ratings

Symbol	Parameter	Value	Unit
V_{CES}	Collector-emitter voltage ($V_{GE} = 0$)	1200	V
$I_C^{(1)}$	Continuous collector current at $T_C = 25\text{ °C}$	80	A
$I_C^{(1)}$	Continuous collector current at $T_C = 100\text{ °C}$	40	A
$I_{CL}^{(2)}$	Turn-off latching current	85	A
$I_{CP}^{(3)}$	Pulsed collector current	120	A
V_{GE}	Gate-emitter voltage	± 25	V
t_{SCW}	Short circuit withstand time, $V_{CE} = 0.5 V_{(BR)CES}$ $T_j = 125\text{ °C}$, $R_G = 10\ \Omega$, $V_{GE} = 12\text{ V}$	10	μs
P_{TOT}	Total dissipation at $T_C = 25\text{ °C}$	240	W
I_F	Diode RMS forward current at $T_C = 25\text{ °C}$	30	A
I_{FSM}	Surge non repetitive forward current $t_p = 10\text{ ms}$ sinusoidal	100	A
T_j	Operating junction temperature	- 55 to 125	$^{\circ}\text{C}$

1. Calculated according to the iterative formula:

$$I_C(T_C) = \frac{T_{j(max)} - T_C}{R_{thj-c} \times V_{CE(sat)(max)}(T_{j(max)}, I_C(T_C))}$$

2. $V_{clamp} = 80\%$ of V_{CES} , $T_j = 125\text{ °C}$, $R_G = 10\ \Omega$, $V_{GE} = 15\text{ V}$

3. Pulse width limited by maximum junction temperature and turn-off within RBSOA

Table 3. Thermal data

Symbol	Parameter	Value	Unit
$R_{thj-case}$	Thermal resistance junction-case IGBT	0.42	$^{\circ}\text{C/W}$
$R_{thj-case}$	Thermal resistance junction-case diode	1.6	$^{\circ}\text{C/W}$
$R_{thj-amb}$	Thermal resistance junction-ambient	50	$^{\circ}\text{C/W}$

2 Electrical characteristics

$T_J = 25\text{ °C}$ unless otherwise specified.

Table 4. Static

Symbol	Parameter	Test conditions	Min.	Typ.	Max.	Unit
$V_{(BR)CES}$	Collector-emitter breakdown voltage ($V_{GE} = 0$)	$I_C = 1\text{ mA}$	1200			V
$V_{CE(sat)}$	Collector-emitter saturation voltage	$V_{GE} = 15\text{ V}$, $I_C = 30\text{ A}$ $V_{GE} = 15\text{ V}$, $I_C = 30\text{ A}$, $T_J = 125\text{ °C}$		2.8 2.7	3.85	V V
$V_{GE(th)}$	Gate threshold voltage	$V_{CE} = V_{GE}$, $I_C = 1\text{ mA}$	4.5		6.5	V
I_{CES}	Collector cut-off current ($V_{GE} = 0$)	$V_{CE} = 1200\text{ V}$ $V_{CE} = 1200\text{ V}$, $T_J = 125\text{ °C}$			500 10	μA mA
I_{GES}	Gate-emitter leakage current ($V_{CE} = 0$)	$V_{GE} = \pm 20\text{ V}$			± 100	nA

Table 5. Dynamic

Symbol	Parameter	Test conditions	Min.	Typ.	Max.	Unit
C_{ies}	Input capacitance	$V_{CE} = 25\text{ V}$, $f = 1\text{ MHz}$, $V_{GE} = 0$		2577		pF
C_{oes}	Output capacitance		-	196	-	pF
C_{res}	Reverse transfer capacitance			39.5		pF
Q_g	Total gate charge	$V_{CE} = 960\text{ V}$, $I_C = 30\text{ A}$, $V_{GE} = 15\text{ V}$		126		nC
Q_{ge}	Gate-emitter charge		-	22.2	-	nC
Q_{gc}	Gate-collector charge			67		nC

Table 6. Switching on/off (inductive load)

Symbol	Parameter	Test conditions	Min.	Typ.	Max.	Unit
$t_{d(on)}$	Turn-on delay time	$V_{CC} = 960\text{ V}$, $I_C = 30\text{ A}$ $R_G = 10\ \Omega$, $V_{GE} = 15\text{ V}$, (see Figure 16)		48		ns
t_r	Current rise time		-	40	-	ns
$(di/dt)_{on}$	Turn-on current slope			540		A/ μs
$t_{d(on)}$	Turn-on delay time	$V_{CC} = 960\text{ V}$, $I_C = 30\text{ A}$ $R_G = 10\ \Omega$, $V_{GE} = 15\text{ V}$, $T_J = 125\text{ °C}$ (see Figure 16)		45		ns
t_r	Current rise time		-	38	-	ns
$(di/dt)_{on}$	Turn-on current slope			665		A/ μs
$t_r(V_{off})$	Off voltage rise time	$V_{CC} = 960\text{ V}$, $I_C = 30\text{ A}$ $R_G = 10\ \Omega$, $V_{GE} = 15\text{ V}$, (see Figure 16)		84		ns
$t_{d(off)}$	Turn-off delay time		-	338	-	ns
t_f	Current fall time			210		ns
$t_r(V_{off})$	Off voltage rise time	$V_{CC} = 960\text{ V}$, $I_C = 30\text{ A}$ $R_G = 10\ \Omega$, $V_{GE} = 15\text{ V}$, $T_J = 125\text{ °C}$ (see Figure 16)		144		ns
$t_{d(off)}$	Turn-off delay time		-	420	-	ns
t_f	Current fall time			360		ns

Table 7. Switching energy (inductive load)

Symbol	Parameter	Test conditions	Min.	Typ.	Max.	Unit
$E_{on}^{(1)}$	Turn-on switching losses	$V_{CC} = 960\text{ V}$, $I_C = 30\text{ A}$		3.7		mJ
$E_{off}^{(2)}$	Turn-off switching losses	$R_G = 10\ \Omega$, $V_{GE} = 15\text{ V}$,	-	5.7	-	mJ
E_{ts}	Total switching losses	(see Figure 16)		9.4		mJ
$E_{on}^{(1)}$	Turn-on switching losses	$V_{CC} = 960\text{ V}$, $I_C = 30\text{ A}$		4.7		mJ
$E_{off}^{(2)}$	Turn-off switching losses	$R_G = 10\ \Omega$, $V_{GE} = 15\text{ V}$,	-	9.3	-	mJ
E_{ts}	Total switching losses	$T_J = 125\text{ }^\circ\text{C}$ (see Figure 16)		14		mJ

- E_{on} is the turn-on losses when a typical diode is used in the test circuit in [Figure 16](#). If the IGBT is offered in a package with a co-pack diode, the co-pack diode is used as external diode. IGBTs and diode are at the same temperature (25°C and 125°C)
- Turn-off losses include also the tail of the collector current

Table 8. Collector-emitter diode

Symbol	Parameter	Test conditions	Min.	Typ.	Max.	Unit
V_F	Forward on-voltage	$I_F = 20\text{ A}$ $I_F = 20\text{ A}$, $T_J = 125\text{ }^\circ\text{C}$	-	1.9 1.7	-	V V
t_{rr}	Reverse recovery time	$I_F = 20\text{ A}$, $V_R = 45\text{ V}$,		84		ns
Q_{rr}	Reverse recovery charge	$di/dt = 100\text{ A}/\mu\text{s}$	-	235	-	nC
I_{rrm}	Reverse recovery current	(see Figure 19)		5.6		A
t_{rr}	Reverse recovery time	$I_F = 20\text{ A}$, $V_R = 45\text{ V}$,		152		ns
Q_{rr}	Reverse recovery charge	$T_J = 125\text{ }^\circ\text{C}$,	-	722	-	nC
I_{rrm}	Reverse recovery current	$di/dt = 100\text{ A}/\mu\text{s}$ (see Figure 19)		9		A

2.1 Electrical characteristics (curves)

Figure 2. Output characteristics

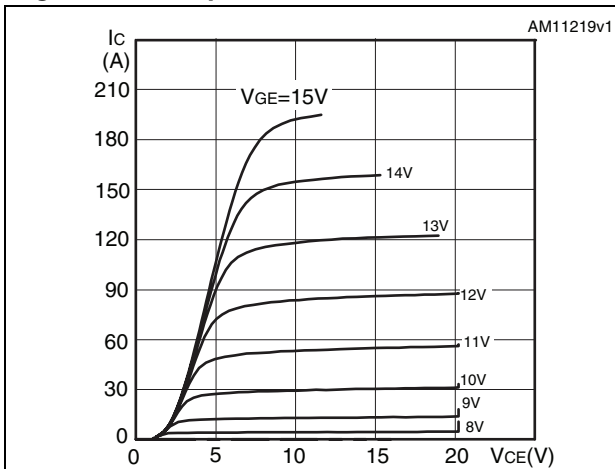

Figure 3. Transfer characteristics

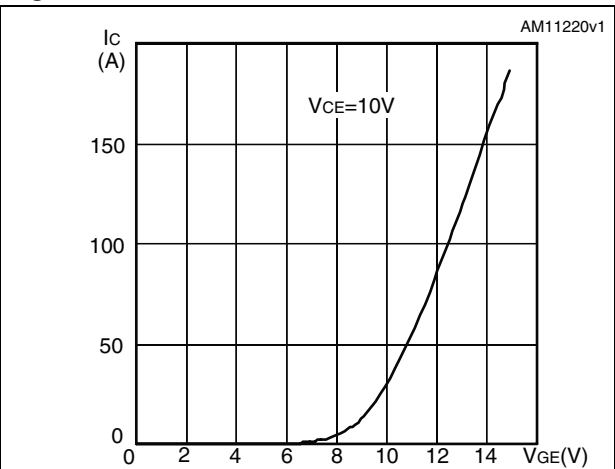

Figure 4. Collector-emitter on voltage vs. collector current

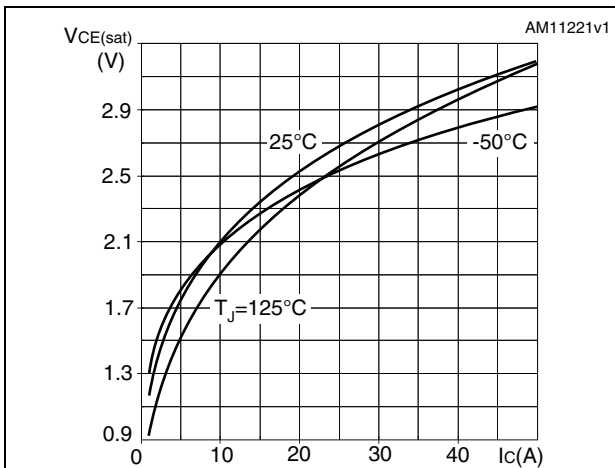

Figure 5. Collector-emitter on voltage vs. temperature

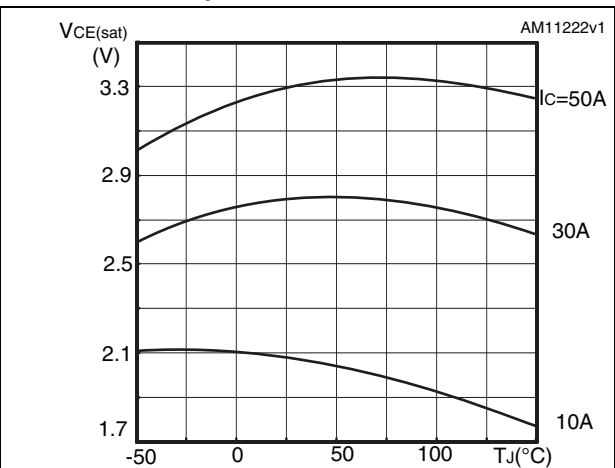

Figure 6. Gate charge vs. gate-source voltage

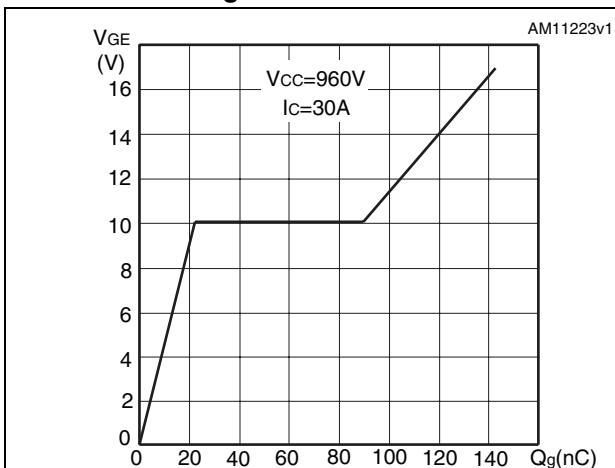

Figure 7. Capacitance variations

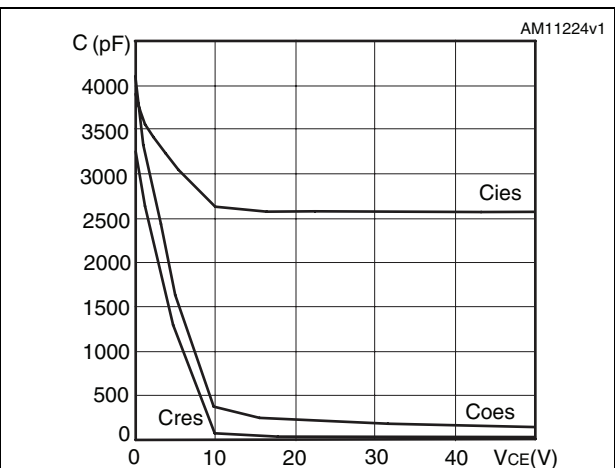

Figure 8. Normalized gate threshold voltage vs. temperature

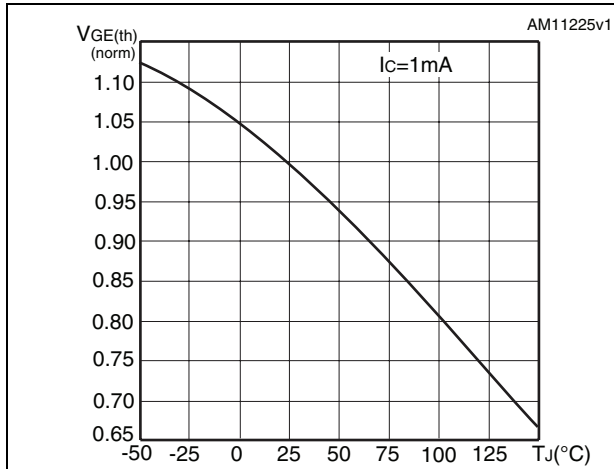

Figure 9. Normalized breakdown voltage vs. temperature

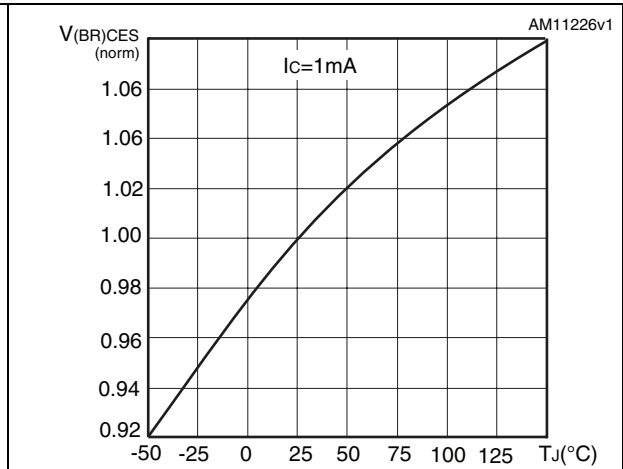

Figure 10. Switching losses vs. collector current

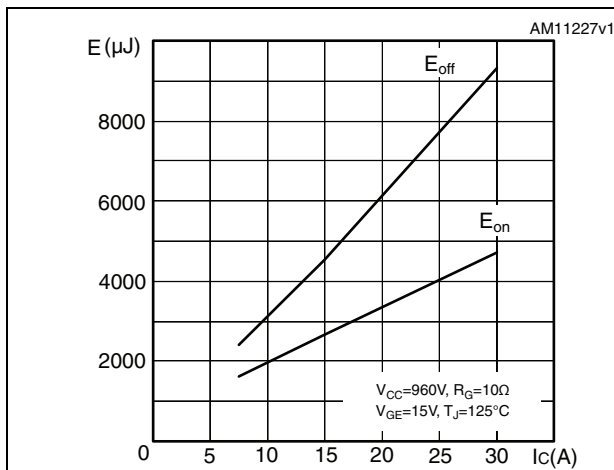

Figure 11. Switching losses vs. gate resistance

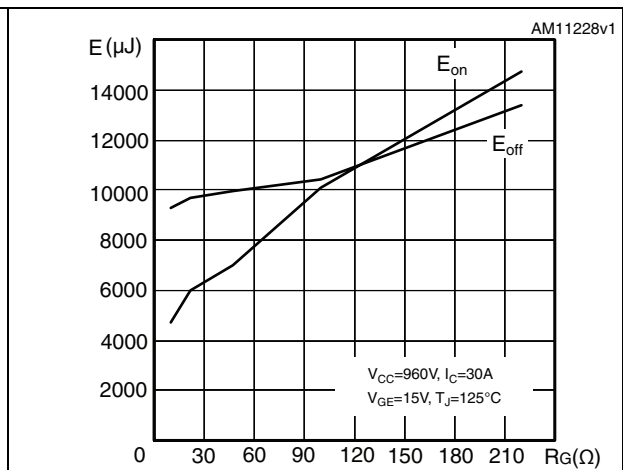

Figure 12. Switching losses vs. temperature

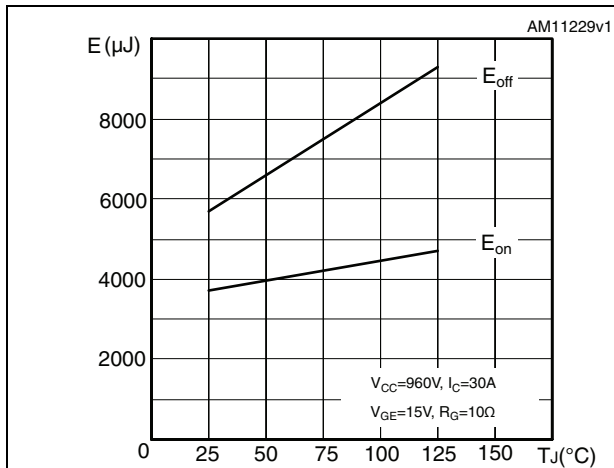

Figure 13. Thermal impedance

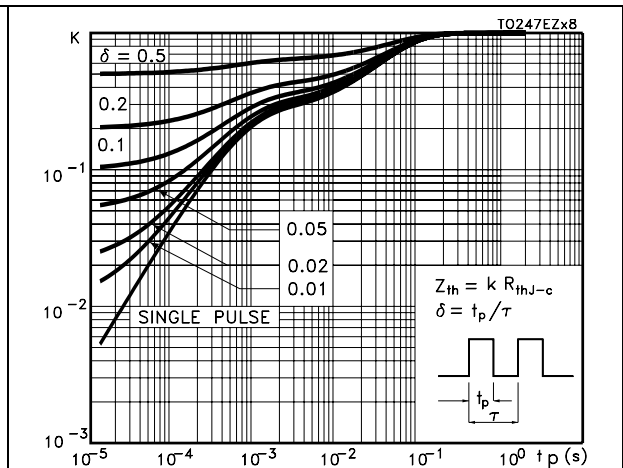

Figure 14. Turn-off SOA

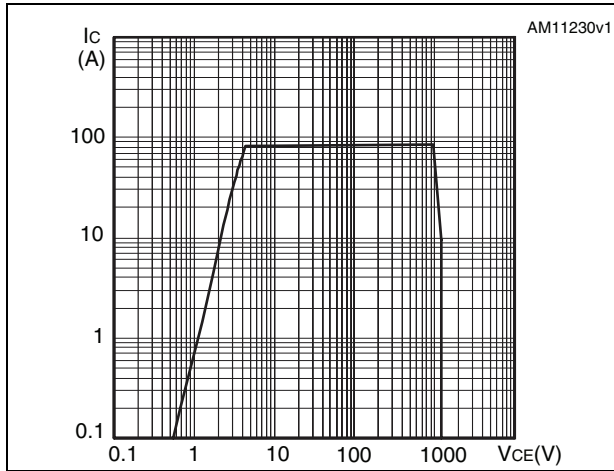
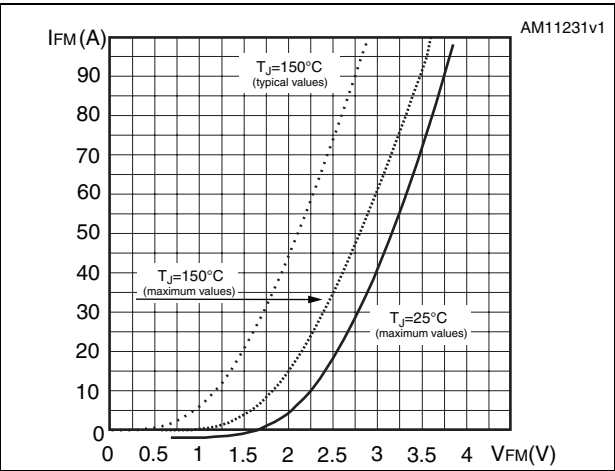
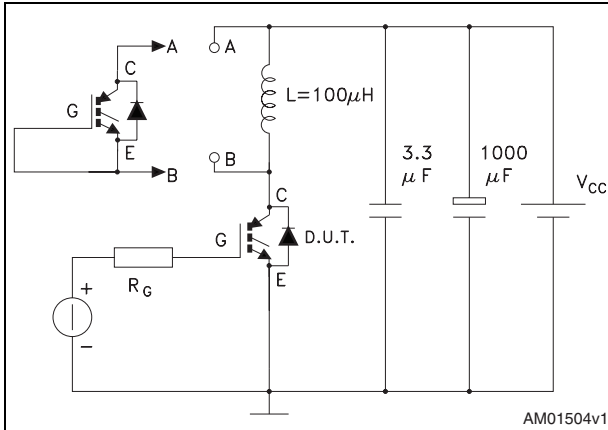

Figure 15. Forward voltage drop vs. forward current



3 Test circuits

Figure 16. Test circuit for inductive load switching



AM01504v1

Figure 17. Gate charge test circuit

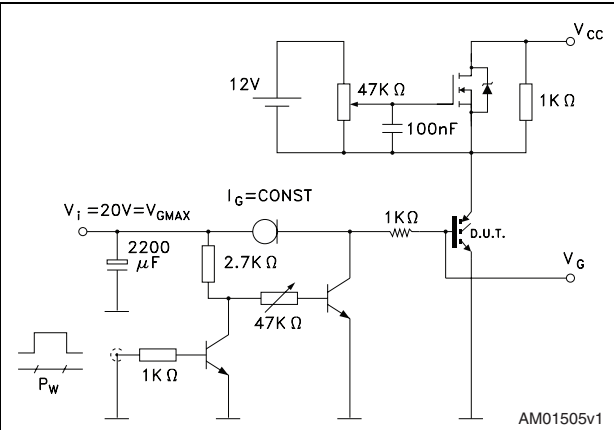

AM01505v1

Figure 18. Switching waveform

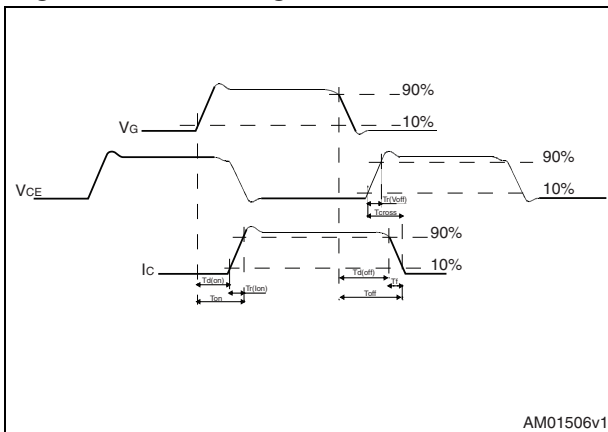

AM01506v1

Figure 19. Diode recovery time waveform

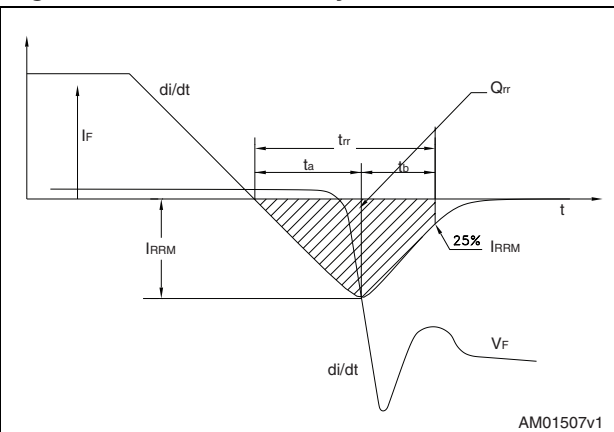

AM01507v1

4 Package mechanical data

In order to meet environmental requirements, ST offers these devices in different grades of ECOPACK® packages, depending on their level of environmental compliance. ECOPACK® specifications, grade definitions and product status are available at: www.st.com. ECOPACK is an ST trademark.

Table 9. TO-247 mechanical data

Dim.	mm.		
	Min.	Typ.	Max.
A	4.85		5.15
A1	2.20		2.60
b	1.0		1.40
b1	2.0		2.40
b2	3.0		3.40
c	0.40		0.80
D	19.85		20.15
E	15.45		15.75
e	5.30	5.45	5.60
L	14.20		14.80
L1	3.70		4.30
L2		18.50	
ØP	3.55		3.65
ØR	4.50		5.50
S	5.30	5.50	5.70

Figure 20. TO-247 drawing dimensions

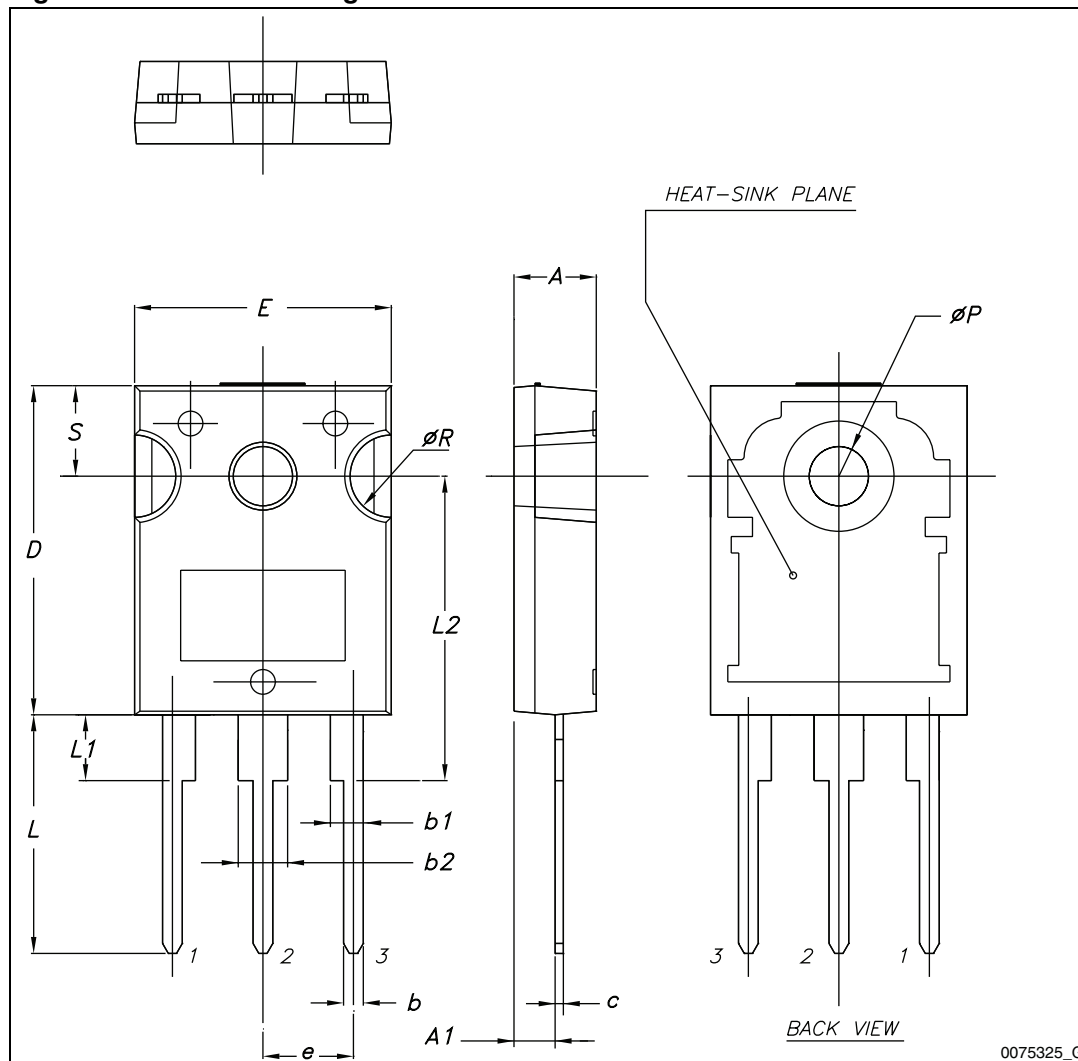
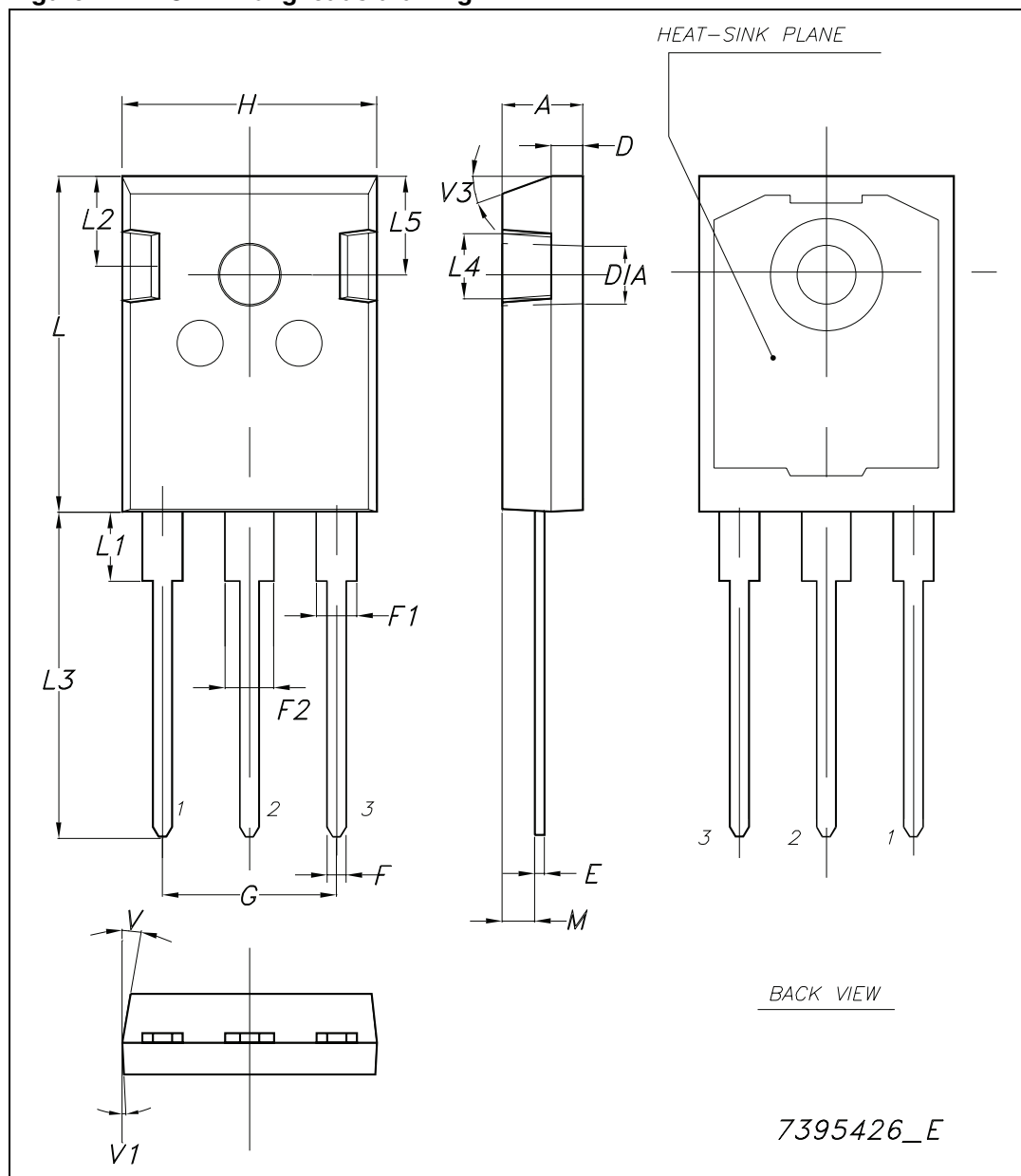

Table 10. TO-247 long leads mechanical data

Dim.	mm		
	Min.	Typ.	Max.
A	4.90		5.15
D	1.85		2.10
E	0.55		0.67
F	1.07		1.32
F1	1.90		2.38
F2	2.87		3.38
G	10.90 BSC		
H	15.77		16.02
L	20.82		21.07
L1	4.16		4.47
L2	5.49		5.74
L3	20.05		20.30
L4	3.68		3.93
L5	6.04		6.29
M	2.27		2.52
V		10°	
V1		3°	
V3		20°	
Dia.	3.55		3.66

Figure 21. TO-247 long leads drawing



5 Revision history

Table 11. Document revision history

Date	Revision	Changes
22-Jan-2009	1	Initial release
29-Jun-2009	2	Document status promoted from preliminary data to datasheet.
09-Jul-2009	3	Inserted dynamic values Table 5 on page 4 , Table 6 on page 4 and Table 7 on page 5 .
11-Jan-2012	4	Added order code STGWA40N120KD Table 1 on page 1 , Section 2.1 on page 6 , mechanical data TO-247 long leads Table 10 on page 12 and Figure 21 on page 13 .
27-Feb-2012	5	Modified: Description on page 1 .

Please Read Carefully:

Information in this document is provided solely in connection with ST products. STMicroelectronics NV and its subsidiaries ("ST") reserve the right to make changes, corrections, modifications or improvements, to this document, and the products and services described herein at any time, without notice.

All ST products are sold pursuant to ST's terms and conditions of sale.

Purchasers are solely responsible for the choice, selection and use of the ST products and services described herein, and ST assumes no liability whatsoever relating to the choice, selection or use of the ST products and services described herein.

No license, express or implied, by estoppel or otherwise, to any intellectual property rights is granted under this document. If any part of this document refers to any third party products or services it shall not be deemed a license grant by ST for the use of such third party products or services, or any intellectual property contained therein or considered as a warranty covering the use in any manner whatsoever of such third party products or services or any intellectual property contained therein.

UNLESS OTHERWISE SET FORTH IN ST'S TERMS AND CONDITIONS OF SALE ST DISCLAIMS ANY EXPRESS OR IMPLIED WARRANTY WITH RESPECT TO THE USE AND/OR SALE OF ST PRODUCTS INCLUDING WITHOUT LIMITATION IMPLIED WARRANTIES OF MERCHANTABILITY, FITNESS FOR A PARTICULAR PURPOSE (AND THEIR EQUIVALENTS UNDER THE LAWS OF ANY JURISDICTION), OR INFRINGEMENT OF ANY PATENT, COPYRIGHT OR OTHER INTELLECTUAL PROPERTY RIGHT.

UNLESS EXPRESSLY APPROVED IN WRITING BY TWO AUTHORIZED ST REPRESENTATIVES, ST PRODUCTS ARE NOT RECOMMENDED, AUTHORIZED OR WARRANTED FOR USE IN MILITARY, AIR CRAFT, SPACE, LIFE SAVING, OR LIFE SUSTAINING APPLICATIONS, NOR IN PRODUCTS OR SYSTEMS WHERE FAILURE OR MALFUNCTION MAY RESULT IN PERSONAL INJURY, DEATH, OR SEVERE PROPERTY OR ENVIRONMENTAL DAMAGE. ST PRODUCTS WHICH ARE NOT SPECIFIED AS "AUTOMOTIVE GRADE" MAY ONLY BE USED IN AUTOMOTIVE APPLICATIONS AT USER'S OWN RISK.

Resale of ST products with provisions different from the statements and/or technical features set forth in this document shall immediately void any warranty granted by ST for the ST product or service described herein and shall not create or extend in any manner whatsoever, any liability of ST.

ST and the ST logo are trademarks or registered trademarks of ST in various countries.

Information in this document supersedes and replaces all information previously supplied.

The ST logo is a registered trademark of STMicroelectronics. All other names are the property of their respective owners.

© 2012 STMicroelectronics - All rights reserved

STMicroelectronics group of companies

Australia - Belgium - Brazil - Canada - China - Czech Republic - Finland - France - Germany - Hong Kong - India - Israel - Italy - Japan - Malaysia - Malta - Morocco - Philippines - Singapore - Spain - Sweden - Switzerland - United Kingdom - United States of America

www.st.com





Компания «ЭлектроПласт» предлагает заключение долгосрочных отношений при поставках импортных электронных компонентов на взаимовыгодных условиях!

Наши преимущества:

- Оперативные поставки широкого спектра электронных компонентов отечественного и импортного производства напрямую от производителей и с крупнейших мировых складов;
- Поставка более 17-ти миллионов наименований электронных компонентов;
- Поставка сложных, дефицитных, либо снятых с производства позиций;
- Оперативные сроки поставки под заказ (от 5 рабочих дней);
- Экспресс доставка в любую точку России;
- Техническая поддержка проекта, помощь в подборе аналогов, поставка прототипов;
- Система менеджмента качества сертифицирована по Международному стандарту ISO 9001;
- Лицензия ФСБ на осуществление работ с использованием сведений, составляющих государственную тайну;
- Поставка специализированных компонентов (Xilinx, Altera, Analog Devices, Intersil, Interpoint, Microsemi, Aeroflex, Peregrine, Syfer, Eurofarad, Texas Instrument, Miteq, Cobham, E2V, MA-COM, Hittite, Mini-Circuits, General Dynamics и др.);

Помимо этого, одним из направлений компании «ЭлектроПласт» является направление «Источники питания». Мы предлагаем Вам помощь Конструкторского отдела:

- Подбор оптимального решения, техническое обоснование при выборе компонента;
- Подбор аналогов;
- Консультации по применению компонента;
- Поставка образцов и прототипов;
- Техническая поддержка проекта;
- Защита от снятия компонента с производства.



Как с нами связаться

Телефон: 8 (812) 309 58 32 (многоканальный)

Факс: 8 (812) 320-02-42

Электронная почта: org@eplast1.ru

Адрес: 198099, г. Санкт-Петербург, ул. Калинина, дом 2, корпус 4, литера А.