

Current transformer - PACT RCP-4000A-UIRO-PT-D95 - 2906234

Please be informed that the data shown in this PDF Document is generated from our Online Catalog. Please find the complete data in the user's documentation. Our General Terms of Use for Downloads are valid (<http://phoenixcontact.com/download>)



Set consisting of a 4-way signal conditioner with push-in connection technology and a Rogowski coil 300 mm in length/95 mm in diameter for AC current measurement on busbars and power lines. The signal conditioner outputs 8 different standard signals on the output side and has one switching output.



Key Commercial Data

Packing unit	1 pc
Weight per Piece (excluding packing)	440.0 g
Custom tariff number	85437090
Country of origin	Germany

Technical data

Measuring transducer supply

Nominal supply voltage	24 V DC
Nominal supply voltage range	9.6 V DC ... 30 V DC
Power consumption	≤ 1 W (at $I_{OUT} = 20$ mA, 9.6 V DC, 600 Ω load)

Measuring coil input data

Frequency measuring range	40 Hz ... 20000 Hz
Position error	< 1 %
Linearity error	0.1 %

Measuring transducer input data

Measuring ranges (current)	100 A 250 A 400 A 630 A 1000 A 1500 A 2000 A 4000 A
Configurable/programmable	Via DIP switches

Measuring transducer signal input

Input signal (at 50 Hz)	100 mV (1000 A)
Input impedance	> 100 k Ω

Measuring coil signal output

Current transformer - PACT RCP-4000A-UIRO-PT-D95 - 2906234

Technical data

Measuring coil signal output

Output signal (at 50 Hz)	100 mV (no load, at 1,000 A)
Output voltage (in no-load operation)	$V_{OUT} = M \cdot di/dt$
Output voltage (sinusoidal, in no-load operation)	100 mV ($V_{OUT} = 2 \cdot \pi \cdot M \cdot f \cdot I$ (M = 0.318 μ H; example: At 50 Hz; I = 1,000 A))

Measuring transducer signal output

Current output signal	0 mA ... 20 mA (via DIP switch)
	4 mA ... 20 mA (via DIP switch)
	0 mA ... 10 mA (via DIP switch)
	2 mA ... 10 mA (via DIP switch)
	0 mA ... 21 mA (Can be set via software)
Voltage output signal	0 V ... 10 V (via DIP switch)
	2 V ... 10 V (via DIP switch)
	0 V ... 5 V (via DIP switch)
	1 V ... 5 V (via DIP switch)
	0 V ... 10.5 V (Can be set via software)
Load/output load current output	$\leq 600 \Omega$ (20 mA)

General data, measuring coil

Length of measuring coil	300 mm
Diameter of measuring coil	8.3 mm ± 0.2 mm
Length of signal cable	3000 mm
Conductor structure signal line	2x 0.22 mm (Signal (tinned))
	1x 0.22 mm (Shielding (tinned))
Coil material	Elastollan
Housing material	PC
Insulation	double insulation
Rated insulation voltage	1000 V AC (rms CAT III)
	600 V AC (rms CAT IV)
Test voltage	10.45 kV (DC / 1 min.)
Basic accuracy	$< \pm 0.21 \%$
UL, USA / Canada	UL 61010 Recognized

General data for measuring transducer

Maximum transmission error	$\leq 0.5 \%$ (From the range end value)
Frequency range	16 Hz ... 1000 Hz
Housing material	PBT
Degree of protection	IP20
Test voltage	3 kV (50 Hz, 1 min.)

Current transformer - PACT RCP-4000A-UIRO-PT-D95 - 2906234

Technical data

General data for measuring transducer

UL, USA / Canada	UL 508 Listed
------------------	---------------

General data

Standards/regulations	IEC 61010-1
	IEC 61010-2-032
Pollution degree	2
Overvoltage category	II
Typical measuring error	< 1 %

Connection data

Connection name	Measuring transducer side
Conductor cross section flexible min.	0.2 mm ²
Conductor cross section flexible max.	2.5 mm ²
Conductor cross section solid min.	0.2 mm ²
Conductor cross section solid max.	2.5 mm ²
Conductor cross section AWG min.	26
Conductor cross section AWG max.	12
Screw thread	M3
Connection method	Push-in connection
Stripping length	10 mm

Dimensions

Width	6.20 mm
Height	110.50 mm
Depth	120.50 mm

Ambient conditions

Ambient temperature (operation)	-30 °C ... 80 °C (Measuring coil)
	-40 °C ... 70 °C (Measuring transducer)
Ambient temperature (storage/transport)	-40 °C ... 80 °C (Measuring coil)
	-40 °C ... 85 °C (Measuring transducer)
Maximum altitude	> 4000 m
Measuring coil degree of protection	IP67 (not assessed by UL)

Classifications

eCl@ss

eCl@ss 5.1	27200303
eCl@ss 6.0	27200303

Current transformer - PACT RCP-4000A-UIRO-PT-D95 - 2906234

Classifications

ETIM

ETIM 4.0	EC002475
ETIM 5.0	EC002475

Drawings

Block diagram

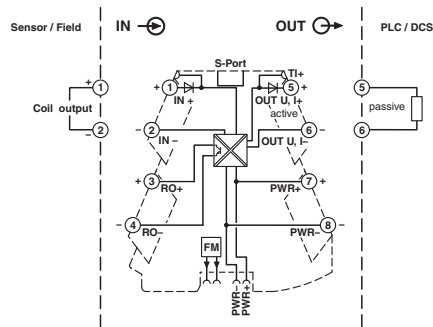



Компания «ЭлектроПласт» предлагает заключение долгосрочных отношений при поставках импортных электронных компонентов на взаимовыгодных условиях!

Наши преимущества:

- Оперативные поставки широкого спектра электронных компонентов отечественного и импортного производства напрямую от производителей и с крупнейших мировых складов;
- Поставка более 17-ти миллионов наименований электронных компонентов;
- Поставка сложных, дефицитных, либо снятых с производства позиций;
- Оперативные сроки поставки под заказ (от 5 рабочих дней);
- Экспресс доставка в любую точку России;
- Техническая поддержка проекта, помощь в подборе аналогов, поставка прототипов;
- Система менеджмента качества сертифицирована по Международному стандарту ISO 9001;
- Лицензия ФСБ на осуществление работ с использованием сведений, составляющих государственную тайну;
- Поставка специализированных компонентов (Xilinx, Altera, Analog Devices, Intersil, Interpoint, Microsemi, Aeroflex, Peregrine, Syfer, Eurofarad, Texas Instrument, Miteq, Cobham, E2V, MA-COM, Hittite, Mini-Circuits, General Dynamics и др.);

Помимо этого, одним из направлений компании «ЭлектроПласт» является направление «Источники питания». Мы предлагаем Вам помощь Конструкторского отдела:

- Подбор оптимального решения, техническое обоснование при выборе компонента;
- Подбор аналогов;
- Консультации по применению компонента;
- Поставка образцов и прототипов;
- Техническая поддержка проекта;
- Защита от снятия компонента с производства.



Как с нами связаться

Телефон: 8 (812) 309 58 32 (многоканальный)

Факс: 8 (812) 320-02-42

Электронная почта: org@eplast1.ru

Адрес: 198099, г. Санкт-Петербург, ул. Калинина, дом 2, корпус 4, литера А.