

## Screwless Clamp Terminal Socket

PYF□□S

- Screwless clamping greatly contributes to reduce wiring time
- No over or under tightening of cable connection so better contact reliability is achieved
- Double wiring possible on all the terminals, and easy bridge and branch connections
- Use either solid or stranded wires from 0.2 to 1.5 mm<sup>2</sup> (AWG24 to AWG16)
- Safe terminal arrangement: Coil terminals separated from contact terminals
- Unique ejector enables easy relay replacement
- Two types of nameplate are available: New MY and Legrand
- Finger-protection construction



## Ordering Information

Item	Part number	
	4-pole	2-pole
Socket	<b>PYF14S</b>	<b>PYF08S</b>
Clip & Release lever	<b>PYCM-14S</b>	<b>PYCM-08S</b>
Nameplate	<b>R99-11 nameplate for MY</b>	
Socket Bridge	<b>PYDM-14SR, PYDM-14SB</b>	<b>PYDM-08SR, PYDM-08SB</b>

## Specifications

Item	PYF14S	PYF08S	Remarks
Relay	MY2 Series MY4 Series	MY2 Series	---
Dimensions	31 × 85 × 36.5 mm max. (W × H × D)	23.2 × 85 × 36.5 mm max. (W × H × D)	---
Rated voltage	250 V AC		---
Rated carry current	10 A at 55°C with MY2 (S) (see note) 5 A at 70°C with MY4 (S)	10 A at 55°C with MY2 (S) 7 A at 70°C with MY2 (S)	VDE0627
Applicable wires	0.2 to 1.5 mm <sup>2</sup> (AWG24 to AWG16) Solid wire Stranded wires		---
Number of wire connections	2 wires per terminal (1 wire per hole)		---
Clamping force	10 N min. (0.2 mm <sup>2</sup> ) 40 N min. (1.5 mm <sup>2</sup> )		EN60999

Note: MY2 (S) can be used at 70°C but at 7 A.

### ■ SAFETY STANDARDS (APPROVAL PENDING)

VDE0627 (IEC664, EN60999)  
UL508 (UL1059)  
CSA C22.2 No. 14 (CSA C22.2 No. 158)

# Dimensions

Unit: mm

## ■ PYF14S

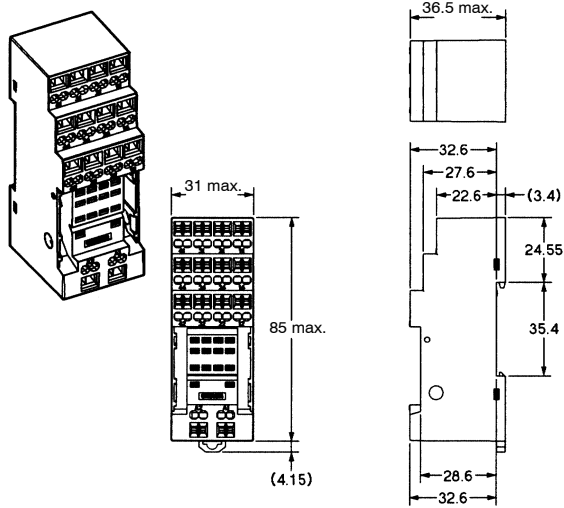

## ■ PYF08S

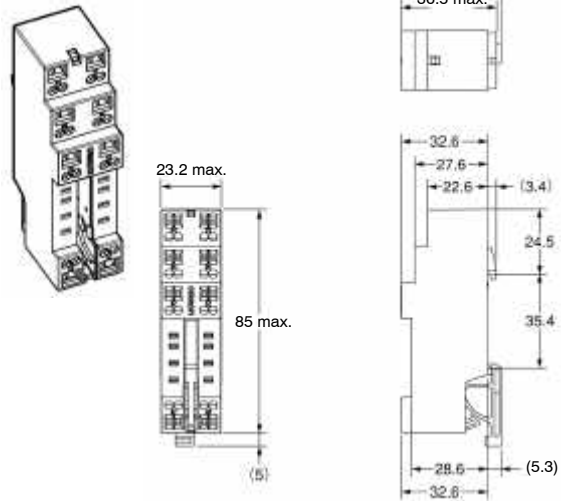

## ■ TERMINAL ARRANGEMENT

### PYF14S

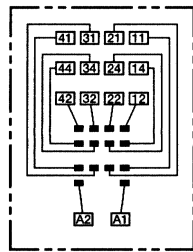

### PYF08S

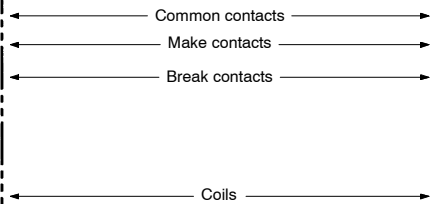
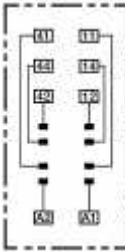

Note: Pole-2 and pole-3 cannot be used with the MY2 type.  
Use pole-1 (terminal numbers: 11, 14, 12) and pole-4 (terminal numbers: 41, 44, 42).

## ■ MOUNTING HEIGHT (WITH LEVER)

### PYF14S

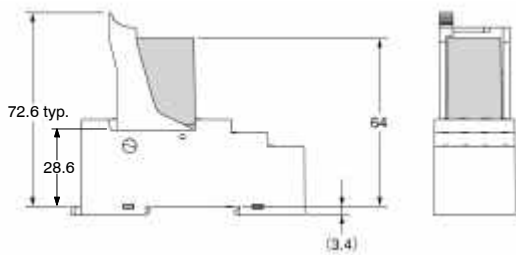

### PYF08S

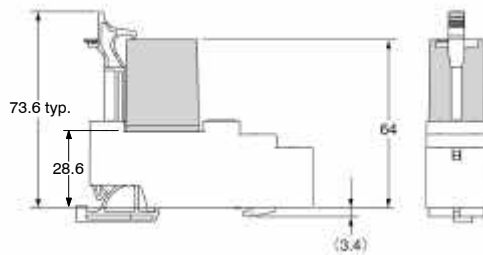

# Accessories (Order separately)

Unit: mm

## ■ SOCKET BRIDGE

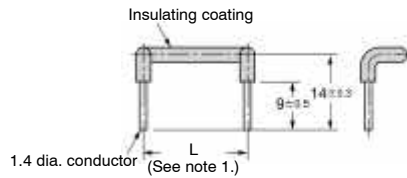

Note: 1. The relationship between the model number, the length L, and the color of the insulating coating is shown in the following table.

Model number	Length L (mm)	Color of insulating coating
PYDM-14SR	27.5±0.3	Red
PYDM-14SB		Blue
PYDM-08SR	19.7±0.3	Red
PYDM-08SB		Blue

2. The insulating coating must be able to withstand a voltage of 1,500 V for 1 minute. Use either PE or PA as the material of the insulating coating.

- The positions of the ends of the insulating coating must not vary more than 0.5 mm.
- The characteristics of the socket bridge are shown in the following table.

Item	Characteristic
Rated ON current	10 A
Rated insulation voltage	250 VAC
Temperature rise	35°C max.
Dielectric strength	1,500 VAC for 1 minute
Ambient operating temperature	-55 to 70°C

## ■ PYF14S LEVER

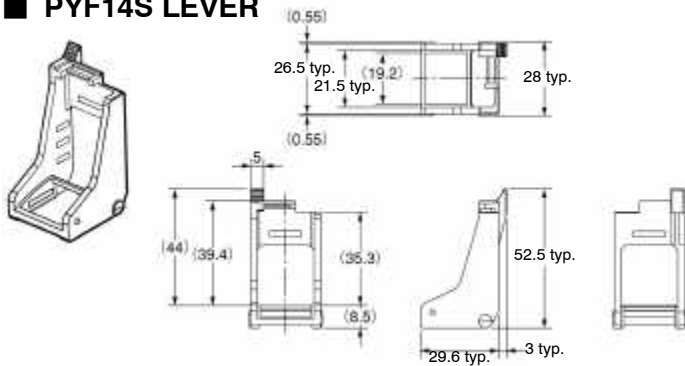

## ■ PYF08S LEVER

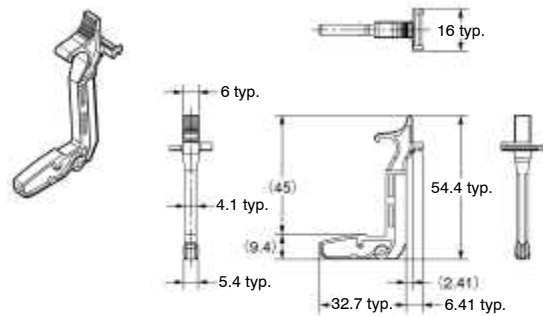

# Installation

## ■ TOOLS

A flat-blade screwdriver should be used to mount the cables.

### Applicable Screwdriver

Flat-blade, Parallel-tip, 2.5 mm diameter (3.0 mm max.)

#### Flat-blade, Parallel-tip



#### Flat-blade, Flared-tip

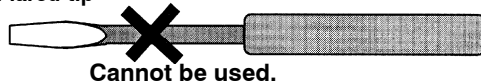

- Examples: FACOM AEF.2.5 × 75E (AEF. 3 × 75E)  
 VESSEL No. 9900(-)2.5 × 75 (No. 9900(-)3 × 100)  
 WAGO 210-119  
 WIHA 260/2.5 × 40 (260/3 × 50)

Note: Chamfering (beveling) the tip of the driver improves insertion when used as an exclusive tool.

## ■ APPLICABLE WIRES

### Applicable Wire Sizes

0.2 to 1.5 mm<sup>2</sup>, AWG24 to AWG16

### Applicable Wire Type

Solid wires, stranded wires, flexible wires, or wires with ferules can be used.

(See note 1) < 2.2 □ Diameter D (mm) □ 3.2 (3.5: see note 2)

Conductor diameter d (mm) or length of sides a and b (mm) □ 1.9

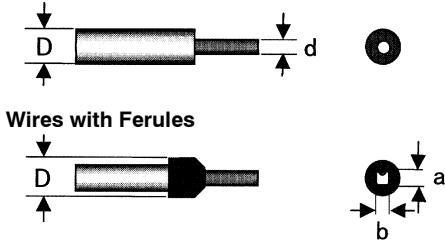

Note: 1. If the overall diameter of the wire is less than 2.2 mm, do not insert the wire past the conductor. Refer to the following diagrams.

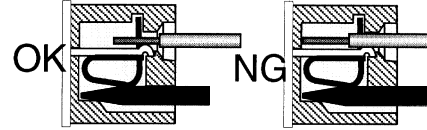

2. If the overall diameter of the wire is over 3.2 mm, it will be difficult to use double wiring.

### Examples of Applicable Wires (Confirmed Using Catalog Information)

Type of wire	Conductor type	See note 1, above.	Recommended wire sizes	See note 2, above.
Equipment wire 2491X	Flexible		0.5, 0.75, 1.0 mm <sup>2</sup>	1.5 mm <sup>2</sup>
BS6004	Solid	0.5 mm <sup>2</sup>		
Switchgear BS6231	Solid		1.0 mm <sup>2</sup>	1.5 mm <sup>2</sup>
Switchgear BS6231	Flexible		0.5, 0.75 mm <sup>2</sup>	1.0 mm <sup>2</sup>
Tri-rated control and switchgear	Flexible		0.5, 0.75, 1.0, 1.5 mm <sup>2</sup>	
Conduit	Stranded		1.5 mm <sup>2</sup>	
UL1007	Flexible	18AWG	16AWG	
UL1015	Flexible		18AWG, 16AWG	
UL1061	Flexible	18AWG		
UL1430	Flexible	18AWG	16AWG	

## ■ WIRING

Use wires of the applicable sizes specified above. The length of the exposed conductor should be 8 to 9 mm.

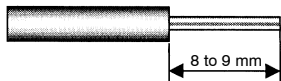

Fig. 1 Exposed Conductor Length

Use the following wiring procedure.

1. Insert the specified screwdriver into the release hole located beside the wire connection hole where the wire is to be inserted.

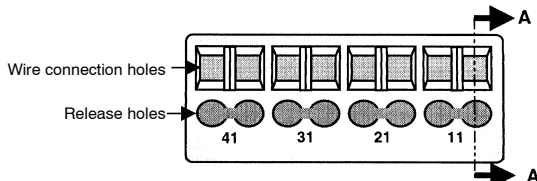

Fig. 2 Wire Connection Holes and Release Holes

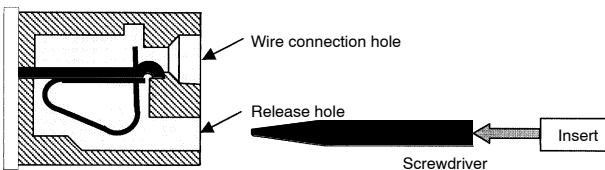
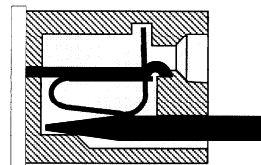
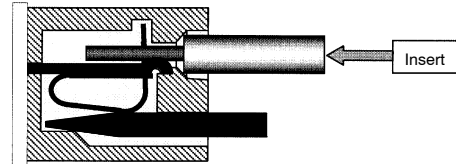

Fig. 3 Section A-A of Fig. 2



2. Insert the exposed conductor into the wire connection hole.



3. Pull out the screwdriver.

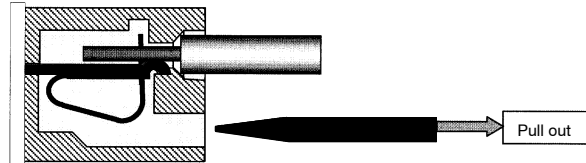

## Precautions

### ■ PRECAUTIONS FOR CONNECTION

Do not move the screwdriver up, down, or from side to side while it is inserted in the hole. Doing so may cause damage to internal components (e.g., deformation of the coil spring or cracks in the housing) or cause deterioration of insulation.

Do not insert the screwdriver at an angle. Doing so may break the side of the socket and result in a short-circuit.

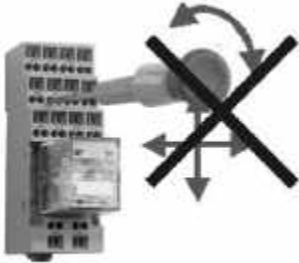

Do not insert two or more wires in the hole. Wires may come in contact with the spring causing a temperature rise or may be subject to sparks. (There are two wiring holes for each terminal.)



Insert the screwdriver along the hole wall as shown below.



If lubricating liquid, such as oil, is present on the tip of the screwdriver, the screwdriver may fall out resulting in injury to the operator.

Insert the screwdriver into the bottom of the hole. It may not be possible to connect cables properly if the screwdriver is inserted incorrectly.

### ■ GENERAL PRECAUTIONS

Use the clip to prevent relays from floating or falling out of the socket.

Do not use the product if it has been dropped on the ground. Dropping the product may adversely affect performance.

Confirm that the socket is securely attached to the mounting track before wiring. If the socket is mounted insecurely it may fall and injure the operator.

Ensure that the socket is not charged during wiring and maintenance. Not doing so may result in electric shock.

Do not pour water or cleaning agents on the product. Doing so may result in electric shock.

Do not use the socket in locations subject to solvents or alkaline chemicals.

Do not use the socket in locations subject to ultraviolet light (e.g., direct sunlight). Doing so may result in markings fading, rust, corrosion or resin deterioration.

Do not dispose of the product in fire.

### ■ REMOVING FROM MOUNTING RAIL

To remove the socket from the mounting rail, insert the tip of the screwdriver in the fixture rail and move it in the direction shown below.

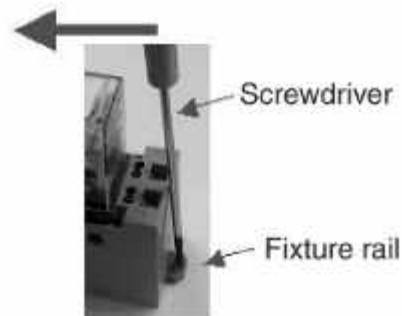

**NOTE: DIMENSIONS SHOWN ARE IN MILLIMETERS. To convert millimeters to inches divide by 25.4.**

**OMRON**<sup>®</sup>

**OMRON ELECTRONICS LLC**

One East Commerce Drive  
Schaumburg, IL 60173

**1-800-55-OMRON**

**OMRON ON-LINE**

Global - <http://www.omron.com>  
USA - <http://www.omron.com/oei>  
Canada - <http://www.omron.com/oci>

**OMRON CANADA, INC.**

885 Milner Avenue  
Scarborough, Ontario M1B 5V8

**416-286-6465**



Компания «ЭлектроПласт» предлагает заключение долгосрочных отношений при поставках импортных электронных компонентов на взаимовыгодных условиях!

Наши преимущества:

- Оперативные поставки широкого спектра электронных компонентов отечественного и импортного производства напрямую от производителей и с крупнейших мировых складов;
- Поставка более 17-ти миллионов наименований электронных компонентов;
- Поставка сложных, дефицитных, либо снятых с производства позиций;
- Оперативные сроки поставки под заказ (от 5 рабочих дней);
- Экспресс доставка в любую точку России;
- Техническая поддержка проекта, помощь в подборе аналогов, поставка прототипов;
- Система менеджмента качества сертифицирована по Международному стандарту ISO 9001;
- Лицензия ФСБ на осуществление работ с использованием сведений, составляющих государственную тайну;
- Поставка специализированных компонентов (Xilinx, Altera, Analog Devices, Intersil, Interpoint, Microsemi, Aeroflex, Peregrine, Syfer, Eurofarad, Texas Instrument, Miteq, Cobham, E2V, MA-COM, Hittite, Mini-Circuits, General Dynamics и др.);

Помимо этого, одним из направлений компании «ЭлектроПласт» является направление «Источники питания». Мы предлагаем Вам помощь Конструкторского отдела:

- Подбор оптимального решения, техническое обоснование при выборе компонента;
- Подбор аналогов;
- Консультации по применению компонента;
- Поставка образцов и прототипов;
- Техническая поддержка проекта;
- Защита от снятия компонента с производства.



#### Как с нами связаться

**Телефон:** 8 (812) 309 58 32 (многоканальный)

**Факс:** 8 (812) 320-02-42

**Электронная почта:** [org@eplast1.ru](mailto:org@eplast1.ru)

**Адрес:** 198099, г. Санкт-Петербург, ул. Калинина, дом 2, корпус 4, литера А.