

## J210, J211, J212 N-Channel JFET

### Features

- InterFET [N0026L Geometry](#)
- Low Noise: 2.5 nV/√Hz Typical
- Low Ciss: 5pF Typical
- Low Leakage: 10pA Typical
- RoHS Compliant
- SMT, TH, and Bare Die Package options.

### Applications

- Audio Amplifiers
- General Purpose Amplifiers

### Description

The -25V InterFET J210, J211, and J212 JFET's are targeted for sensitive amplifier stages with gate leakages typically less than 10pA at room temperatures.

SOT23 Top View

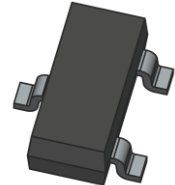
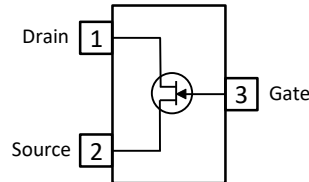

TO-92 Bottom View

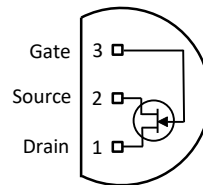

### Product Summary

Parameters	J210 Min	J211 Min	J212 Min	Unit
$BV_{GSS}$ Gate to Source Breakdown Voltage	-25	-25	-25	V
$I_{DSS}$ Drain to Source Saturation Current	2	7	15	mA
$V_{GS(off)}$ Gate to Source Cutoff Voltage	-1	-2.5	-4	V
$G_{FS}$ Forward Transconductance	4	6	7	mS

### Ordering Information Custom Part and Binning Options Available

Part Number	Description	Case	Packaging
J210; J211; J212	Through-Hole	TO-92	Bulk
SMPJ210; SMPJ211; SMPJ212	Surface Mount	SOT23	Bulk
SMPJ210TR; SMPJ211TR; SMPJ212TR	7" Tape and Reel: Max 3,000 Pieces 13" Tape and Reel: Max 9,000 Pieces	SOT23	Minimum 1,000 Pieces Tape and Reel
J210COT; J211COT; J212COT	Chip Orientated Tray (COT Waffle Pack)	COT	400/Waffle Pack
J210CFT; J211CFT; J212CFT	Chip Face-up Tray (CFT Waffle Pack)	CFT	400/Waffle Pack



**Disclaimer:** It is the Buyers responsibility for designing, validating and testing the end application under all field use cases and extreme use conditions. Guaranteeing the application meets required standards, regulatory compliance, and all safety and security requirements is the responsibility of the Buyer. These resources are subject to change without notice.

## Electrical Characteristics

### Maximum Ratings (@ T<sub>A</sub> = 25°C, Unless otherwise specified)

Parameters	Value	Unit
V <sub>RGS</sub> Reverse Gate Source and Gate Drain Voltage	-25	V
I <sub>FG</sub> Continuous Forward Gate Current	10	mA
P <sub>D</sub> Continuous Device Power Dissipation	360	mW
P Power Derating	3.27	mW/°C
T <sub>J</sub> Operating Junction Temperature	-55 to 125	°C
T <sub>STG</sub> Storage Temperature	-65 to 150	°C

### Static Characteristics (@ T<sub>A</sub> = 25°C, Unless otherwise specified)

Parameters	Conditions	J210		J211		J212		Unit
		Min	Max	Min	Max	Min	Max	
V <sub>(BR)GSS</sub> Gate to Source Breakdown Voltage	V <sub>DS</sub> = 0V, I <sub>G</sub> = -1μA	-25		-25		-25		V
I <sub>GSS</sub> Gate to Source Reverse Current	V <sub>GS</sub> = -15V, V <sub>DS</sub> = 0V		-100		-100		-100	pA
I <sub>G</sub> Gate Operating Current	V <sub>DS</sub> = 10V, I <sub>D</sub> = 1mA	-10 (typ)		-10 (typ)		-10 (typ)		pA
V <sub>GS(OFF)</sub> Gate to Source Cutoff Voltage	V <sub>DS</sub> = 15V, I <sub>D</sub> = 1nA	-1	-3	-2.5	-4.5	-4	-6	V
I <sub>DSS</sub> Drain to Source Saturation Current	V <sub>GS</sub> = 0V, V <sub>DS</sub> = 15V (Pulsed)	2	15	7	20	15	40	mA

### Dynamic Characteristics (@ T<sub>A</sub> = 25°C, Unless otherwise specified)

Parameters	Conditions	J210		J211		J212		Unit
		Min	Max	Min	Max	Min	Max	
G <sub>FS</sub> Forward Transconductance	V <sub>DS</sub> = 15V, V <sub>GS</sub> = 0V, f = 1kHz	4	12	6	12	7	10	mS
G <sub>OS</sub> Output Conductance	V <sub>DS</sub> = 15V, V <sub>GS</sub> = 0V, f = 1kHz		150		200		200	μS
C <sub>ISS</sub> Input Capacitance	V <sub>DS</sub> = 15V, V <sub>GS</sub> = 0V, f = 1MHz	4 (typ)		4 (typ)		4 (typ)		pF
C <sub>RSS</sub> Reverse Transfer Capacitance	V <sub>DS</sub> = 15V, V <sub>GS</sub> = 0V, f = 1MHz	1 (typ)		1 (typ)		1 (typ)		pF
e <sub>n</sub> Noise Voltage	V <sub>DS</sub> = 15V, V <sub>GS</sub> = 0V, f = 1kHz	10 (typ)		10 (typ)		10 (typ)		nV/√Hz

## SOT23 (TO-236AB) Mechanical and Layout Data

### Package Outline Data



1. All linear dimensions are in millimeters.
2. Package weight approximately 0.12 grams
3. Molded plastic case UL 94V-0 rated
4. For Tape and Reel specifications refer to InterFET CTC-021 Tape and Reel Specification, Document number: IF39002
5. Bulk product is shipped in standard ESD shipping material
6. Refer to JEDEC standards for additional information.

### Suggested Pad Layout



1. All linear dimensions are in millimeters.
2. The suggested land pattern dimensions have been provided for reference only. A more robust pattern may be desired for wave soldering.

## TO-92 Mechanical and Layout Data

### Package Outline Data

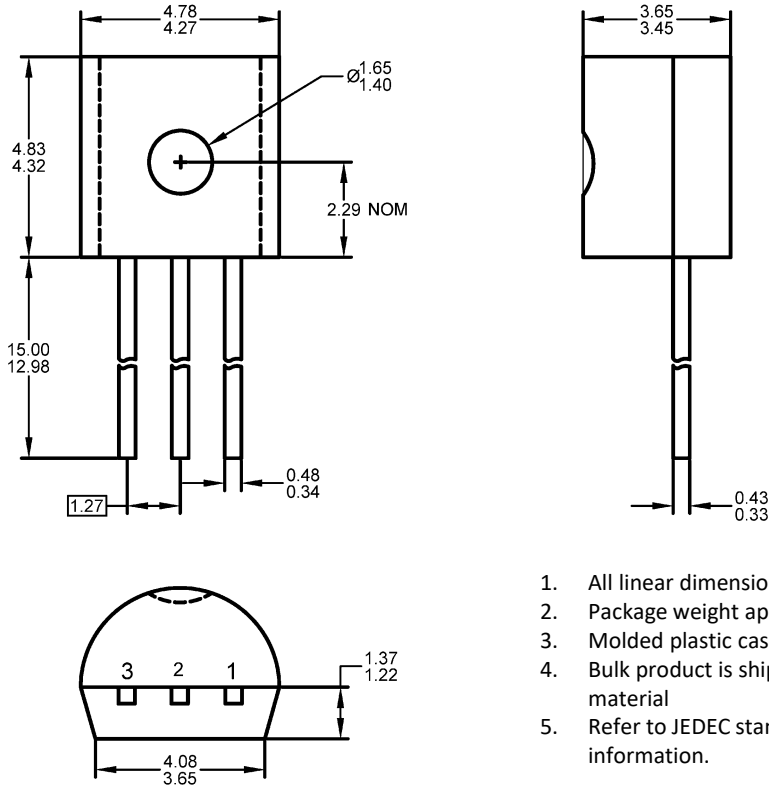

1. All linear dimensions are in millimeters.
2. Package weight approximately 0.19 grams
3. Molded plastic case UL 94V-0 rated
4. Bulk product is shipped in standard ESD shipping material
5. Refer to JEDEC standards for additional information.

### Suggested Through-Hole Layout

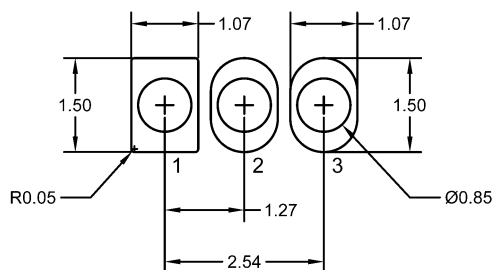

1. All linear dimensions are in millimeters.
2. The suggested land pattern dimensions have been provided as a straight lead reference only. A more robust pattern may be desired for wave soldering and/or bent lead configurations.



Компания «ЭлектроПласт» предлагает заключение долгосрочных отношений при поставках импортных электронных компонентов на взаимовыгодных условиях!

Наши преимущества:

- Оперативные поставки широкого спектра электронных компонентов отечественного и импортного производства напрямую от производителей и с крупнейших мировых складов;
- Поставка более 17-ти миллионов наименований электронных компонентов;
- Поставка сложных, дефицитных, либо снятых с производства позиций;
- Оперативные сроки поставки под заказ (от 5 рабочих дней);
- Экспресс доставка в любую точку России;
- Техническая поддержка проекта, помощь в подборе аналогов, поставка прототипов;
- Система менеджмента качества сертифицирована по Международному стандарту ISO 9001;
- Лицензия ФСБ на осуществление работ с использованием сведений, составляющих государственную тайну;
- Поставка специализированных компонентов (Xilinx, Altera, Analog Devices, Intersil, Interpoint, Microsemi, Aeroflex, Peregrine, Syfer, Eurofarad, Texas Instrument, Miteq, Cobham, E2V, MA-COM, Hittite, Mini-Circuits, General Dynamics и др.);

Помимо этого, одним из направлений компании «ЭлектроПласт» является направление «Источники питания». Мы предлагаем Вам помощь Конструкторского отдела:

- Подбор оптимального решения, техническое обоснование при выборе компонента;
- Подбор аналогов;
- Консультации по применению компонента;
- Поставка образцов и прототипов;
- Техническая поддержка проекта;
- Защита от снятия компонента с производства.



#### Как с нами связаться

**Телефон:** 8 (812) 309 58 32 (многоканальный)

**Факс:** 8 (812) 320-02-42

**Электронная почта:** [org@eplast1.ru](mailto:org@eplast1.ru)

**Адрес:** 198099, г. Санкт-Петербург, ул. Калинина, дом 2, корпус 4, литера А.