

## General Specifications

### Electrical Capacity (Resistive Load)

<b>Power Level (silver):</b>	6A @ 125V AC & 3A @ 250V AC or 3A @ 30V DC	
<b>Logic Level (gold):</b>	0.4VA maximum @ 28V AC/DC maximum (Applicable Range 0.1mA ~ 0.1A @ 20mV ~ 28V)	
<b>Logic/Power Level: (gold over silver)</b>	Combines silver & gold ratings	

Note: Find additional explanation dual rating & operating range in Supplement section.

### Other Ratings

<b>Contact Resistance:</b>	10 milliohms maximum for silver; 20 milliohms maximum for gold
<b>Insulation Resistance:</b>	1,000 megohms minimum @ 500V DC
<b>Dielectric Strength:</b>	1,000V AC minimum between contacts for 1 minute minimum; 1,500V AC minimum between contacts & case for 1 minute minimum
<b>Mechanical Life:</b>	50,000 operations minimum for splashproof models; 100,000 for all other models
<b>Electrical Life:</b>	25,000 operations minimum for silver; 50,000 operations minimum for gold 50,000 operations minimum for silver at 3A @ 125V AC

**Nominal Operating Force:** Momentary Action: 1-pole 9.32N; 2-pole 16.18N; 4-pole 25.54N;  
Alternate Action: 1-pole 4.41N; 2-pole 7.06N; 4-pole 11.77N

<b>Contact Timing:</b>	Slow make, slow break		
<b>Plunger Travel:</b>	Screw-on Cap (Mom.)	Screw-on Cap (Alt.)	Snap-on Cap (Mom. & Alt.)
<b>Pretravel:</b>	.028" (0.71mm)	.110" (2.80mm)	.125" (3.19mm)
<b>Overtravel:</b>	.043" (1.09mm)	.043" (1.10mm)	.050" (1.26mm)
<b>Total Travel</b>	.071" (1.80mm)	.153" (3.90mm)	.175" (4.45mm)

### Materials & Finishes

<b>Plunger:</b>	Brass w/nickel plating; polyacetal w/B1 bushing	<b>Bushing:</b>	Brass with nickel plating
<b>Frame:</b>	Stainless steel	<b>Case:</b>	Diallyl phthalate resin (UL94V-0)
<b>Movable Contactor:</b>	Phosphor bronze with silver or gold plating		
<b>Movable Contacts:</b>	Silver alloy (code W); copper with gold plating (code G); or silver alloy with gold plating (code A)		
<b>Stationary Contacts:</b>	Silver with silver plating (code W); copper or brass with gold plating (code G); or silver with gold plating (code A)		
<b>Terminals:</b>	Copper or brass with silver plating; copper or brass with gold plating		

### Environmental Data

<b>Operating Temp Range:</b>	-30°C through +85°C (-22°F through +185°F)
<b>Humidity:</b>	90 ~ 95% humidity for 96 hours @ 40°C (104°F)
<b>Vibration:</b>	10 ~ 55Hz with peak-to-peak amplitude of 1.5mm traversing the frequency range & returning in 1 minute; 3 right angled directions for 2 hours
<b>Shock:</b>	50G (490m/s <sup>2</sup> ) acceleration (tested in 6 right angled directions, with 5 shocks in each direction)
<b>Sealing:</b>	B3 & D3 bushing options equivalent to IP67

### Installation

<b>Mounting Torque:</b>	1.5Nm (13.0 lb•in) for double nut; .7Nm (6.0 lb•in) for single nut
<b>Cap Installation Force:</b>	80.0N (18.0 lbf) maximum downward force on actuator
<b>Soldering Time &amp; Temp:</b>	Wave Soldering (PC version): See Profile A in Supplement section. Manual Soldering: See Profile A in Supplement section.
<b>Process Seal:</b>	These devices are not process sealed. Hand clean locally using alcohol based solution.

### Standards & Certifications

<b>Flammability Standards:</b>	UL94V-0 case
<b>UL:</b>	<b>File No. E44145 - Recognized only when ordered with marking on switch.</b> Add "/U" or "/CUL" before dash in part number to order UL recognized switch. All models recognized at 6A @ 125V AC or 3A @ 250V AC or 0.4VA max. @ 28V DC max.
<b>CSA:</b>	<b>File No. 023535_0_000 - Certified only when ordered with marking on switch.</b> Add "/C" before dash in part number to order CSA certified switch. All models certified at 6A @ 125V AC or 3A @ 250V AC or 0.4VA max. @ 28V max.

# Distinctive Characteristics

Guide interlocked with actuator block prevents window locking and maintains correct plunger alignment to assure contact stability.

Employs an over-center actuator mechanism, which diminishes sparking and increases operating life in AC circuits.

High torque bushing construction prevents rotation or separation from frame during installation.

Splashproof option (D3 and B3 bushing codes) features an o-ring within the bushing and one under the face nut to protect from splashed, sprayed, or spilled liquids.

High insulating barriers, formed in the molded diallyl phthalate case, increase isolation of circuits in multipole devices.

Prominent external insulating barriers increase insulation resistance and dielectric strength.



Epoxy sealed terminals prevent entry of solder flux and other contaminants.

Clinching of the frame to the case well above the base and terminals provides 1,500V dielectric strength.



Actual Size



	Bushing Mount	Page C74
	Bracket PC Mount	Page C80
	Large Bushing	Page C87

- Toggle
- Rockers
- Pushbuttons**
- Illuminated PB
- Programmable
- Keylocks
- Rotaries
- Slides
- Tactiles
- Tilt
- Touch
- Indicators
- Accessories
- Supplement

## TYPICAL SWITCH ORDERING EXAMPLE

**MB** **2011** **S** **S1** **W** **01** — **C** **A**

Poles & Circuits			
2011	SPDT	ON	(ON)
2065	SPDT	ON	ON
2061	DPDT	ON	(ON)
2085	DPDT	ON	ON
2181	4PDT	ON	(ON)
2185	4PDT	ON	ON

( ) = Momentary

Contact Materials & Ratings	
<b>W</b>	Silver Rated 6A @ 125V AC & 3A @ 250V AC
<b>G</b>	Gold Rated 0.4VA max @ 28V AC/DC max
<b>A</b>	Gold over Silver Rated 6A @ 125V AC & 0.4VA max @ 28V AC/DC max

Caps	
<b>B</b>	.315" (8.0mm) Diameter
<b>C</b>	.394" (10.0mm) Diameter

Cap Colors	
<b>A</b>	Black
<b>B</b>	White
<b>C</b>	Red
<b>E</b>	Yellow
<b>F</b>	Green
<b>G</b>	Blue
<b>H</b>	Gray

Plunger Types	
<b>S</b>	Plunger for Screw-on Caps
<b>L</b>	Plunger for Snap-on Caps

Bushings	
<b>S1</b>	.335" (8.5mm) Threaded with Keyway
<b>S2</b>	.335" (8.5mm) Smooth with Keyway
<b>S4</b>	.335" (8.5mm) Metric Threaded with Keyway
<b>D1</b>	.335" (8.5mm) Threaded with D-Flat
<b>D3</b>	.335" (8.5mm) Threaded Splashproof without Keyway

Terminals	
<b>01</b>	Solder Lug*
<b>02</b>	Quick Connect
<b>03</b>	.250" (6.35mm) Straight PC
<b>05</b>	.425" (10.8mm) Wirewrap
<b>06</b>	.750" (19.05mm) Wirewrap
<b>07</b>	.964" (24.5mm) Wirewrap
<b>08</b>	1.062" (27.0mm) Wirewrap

### IMPORTANT:





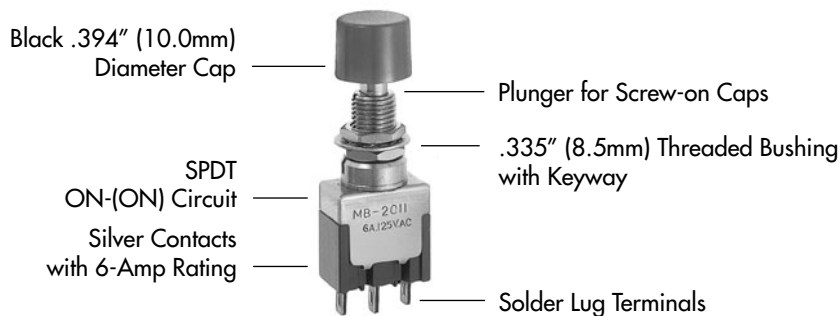

Switches are supplied without UL, cULus & CSA marking unless specified. **UL, cULus & CSA recognized only when ordered with marking on the switch.** Specific models, ratings, & ordering instructions are noted on General Specifications page.

### DESCRIPTION FOR TYPICAL ORDERING EXAMPLE

**MB2011SS1W01-CA**

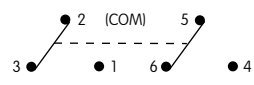
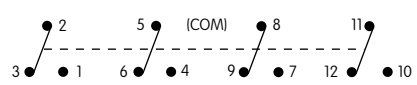

\* Wire harness & cable assemblies offered only in Americas

POLES & CIRCUITS						
Pole	Model	Plunger Position ( ) = Momentary		Connected Terminals		Throw & Switch Schematics
		Normal  Keyway	Down 	Normal  Keyway	Down 	
SP	MB2011	ON	(ON)	2-3	2-1	SPDT 
	MB2065	ON	ON			
DP	MB2061	ON	(ON)	2-3 5-6	2-1 5-4	DPDT 
	MB2085	ON	ON			
4P	MB2181	ON	(ON)	2-3 5-6	2-1 5-4	4PDT 
	MB2185	ON	ON	8-9 11-12	8-7 11-10	

## PLUNGER TYPES

On alternate action models, after transferring circuit, the plunger returns to its original position and does not latch down.



### Plunger for Screw-on Caps



Momentary Plunger Length



Momentary Cap Location



Alternate Plunger Length

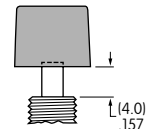

Alternate Cap Location



### Plunger for Snap-on Caps



Momentary & Alternate Plunger Length



Momentary & Alternate Cap Location

## BUSHINGS

**S1** .335" (8.5mm)  
Threaded with Keyway

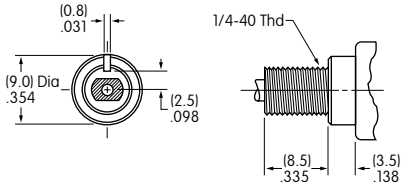

**S2** .335" (8.5mm)  
Smooth with Keyway



**S4** .335" (8.5mm) Metric  
Threaded with Keyway



Maximum Panel Thickness with  
Standard Hardware: .154" (3.9mm)

Maximum Panel Thickness with  
Standard Hardware: .154" (3.9mm)

**D1** .335" (8.5mm)  
Threaded with D Flat

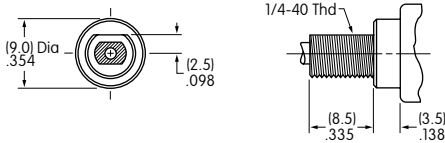

Maximum Panel Thickness with  
Standard Hardware: .154" (3.9mm)

**D3** .335" (8.5mm)  
Threaded Splashproof without Keyway

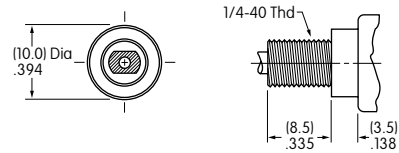

Maximum Panel Thickness with  
Standard Hardware: .240" (6.1mm)

## Panel Cutouts

For S1, S2, or S4 Bushing  
with  
Keyway



For S1 or S4 Bushing  
with  
Optional Locking Ring



For D1 Bushing  
with  
D Flat

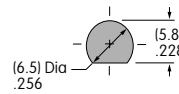

For D3 Bushing  
without  
Keyway

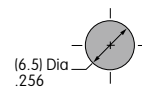

Standard hardware for bushings S1, S4, & D1 includes 2 hex nuts & 1 lockwasher; D3 bushing has 1 hex nut & 1 o-ring.  
Standard & optional hardware are illustrated following the Typical Switch Dimension drawings.

## CONTACT MATERIALS & RATINGS

**W** Silver over Silver      Power Level      6A @ 125V AC & 3A @ 250V AC

**G** Gold over Brass or Copper      Logic Level      0.4VA maximum @ 28V AC/DC maximum  
Note: Complete explanation of operating range in Supplement section.

**A** Gold over Silver      Power Level  
or Logic Level      6A @ 125V AC & 3A @ 250V AC  
or 0.4VA maximum @ 28V AC/DC maximum

Note: This dual rated option is suitable when two or more identical switches are used in logic and in power circuits within the same application. See Supplement section for complete explanation of dual rating and operating range.

Toggles  
Rockers  
Pushbuttons  
Illuminated PB  
Programmable  
Keylocks  
Rotaries  
Slides  
Tactiles  
Tilt  
Touch  
Indicators  
Accessories  
Supplement

## TERMINALS

**01** Solder Lug

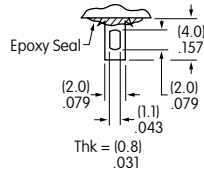

**02** .062" (1.57mm) Wide Quick Connect

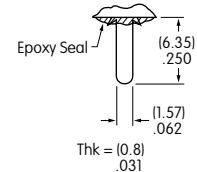

**03** .250" (6.35mm) Straight PC

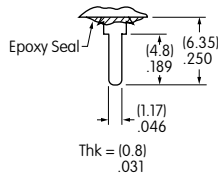

Single Pole

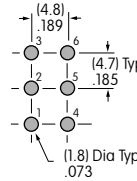

Double Pole

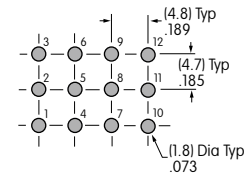

Four Pole

**05** .425" (10.8mm) Wirewrap or Extended PC

**06** .750" (19.05mm) Wirewrap or Extended PC

**07** .964" (24.5mm) Wirewrap or Extended PC

**08** 1.062" (27.0mm) Wirewrap or Extended PC

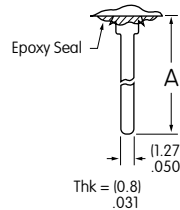

If using as extended PC terminal, refer to the above footprints.

Dimension A = terminal lengths as shown beside the terminal codes at the left.

## CAPS & CAP COLORS

**B** AT413  
.315" (8.0mm) Diameter  
Screw-on Cap

AT443  
.315" (8.0mm) Diameter  
Snap-on Cap

**C** AT407  
.394" (10.0mm) Diameter  
Screw-on Cap

AT442  
.394" (10.0mm) Diameter  
Snap-on Cap

For use with Plunger Code S

For use with Plunger Code L

For use with Plunger Code S

For use with Plunger Code L

Cap Material: PBT  
Finish: Glossy

Cap Material: Polycarbonate  
Finish: Glossy

Cap Material: PBT  
Finish: Glossy

Cap Material: Polycarbonate  
Finish: Glossy

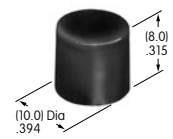
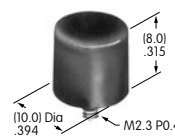
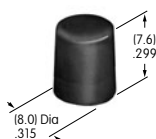
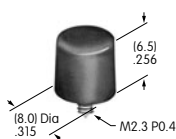

Cap Colors Available:

**A**

Black

**B**

White

**C**

Red

**E**

Yellow

**F**

Green

**G**

Blue

**H**

Gray

## TYPICAL SWITCH DIMENSIONS

### Solder Lug

### Single Pole

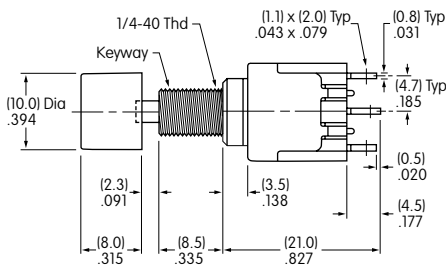

MB2011SS1W01-CA

### Solder Lug

### Double Pole

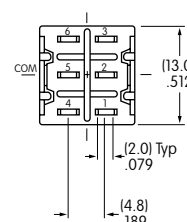
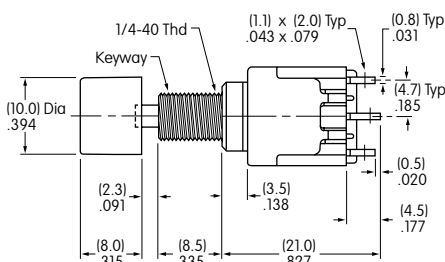
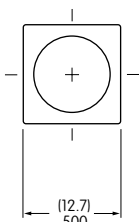

MB2061SS1W01-CA

### Solder Lug

### Four Pole

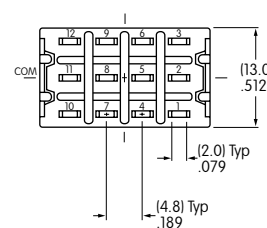
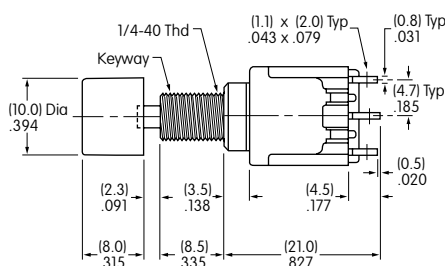
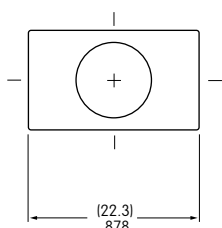

MB2181SS1W01-CA

Toggles

Rockers

Pushbuttons

Illuminated PB

Programmable

Keylocks

Rotaries

Slides

Tactiles

Tilt

Touch

Indicators

Accessories

Supplement

## HARDWARE

### Standard Hardware

### Optional Hardware

#### AT513H for Inch AT513M for Metric Hexagon Nut

2 included with each switch  
(1 with splashproof models)

Material:  
Brass with Nickel plating



#### AT509 Lockwasher

1 included with each switch  
(not with splashproof models)

Material:  
Steel with Zinc/Chromate



#### AT516 O-ring for Splashproof Bushing

1 included with  
each splashproof model

Material:  
Nitrile butadiene rubber



#### AT507H for Inch AT507M for Metric Locking Ring

Material:  
Steel with Zinc/Chromate



### Optional Mounting Collars/Conical Nuts

### Optional Splashproof Boots for S Plunger

#### AT512H for Inch AT512M for Metric Conical Nut

Used with .315" (8.0mm)  
Diameter Cap (cap code B)  
Material:  
Brass with chrome plating



#### AT512CH for Inch AT512CM for Metric Conical nut

Used with .394" (10.0mm)  
Diameter Cap (cap code C)  
Material:  
Brass with chrome plating



Dimension A = Cap Height

.091" (2.3mm) for Momentary with Plunger Code S  
.157" (4.0mm) for Alternate with Plunger Code S  
.142" (3.6mm) for Momentary & Alternate with Plunger Code L

#### AT4041H for Inch AT4041M for Metric Boot for Momentary

Material:  
Silicone rubber



Operating Life 100,000

Boots for momentary devices  
are accompanied by a threaded  
adaptor which extends the length  
of the plunger.

#### AT4042H for Inch AT4042M for Metric Boot for Alternate

Material:  
Silicone rubber

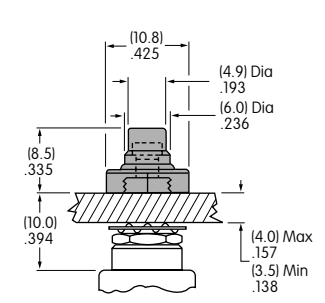

Operating Life 30,000





Компания «ЭлектроПласт» предлагает заключение долгосрочных отношений при поставках импортных электронных компонентов на взаимовыгодных условиях!

Наши преимущества:

- Оперативные поставки широкого спектра электронных компонентов отечественного и импортного производства напрямую от производителей и с крупнейших мировых складов;
- Поставка более 17-ти миллионов наименований электронных компонентов;
- Поставка сложных, дефицитных, либо снятых с производства позиций;
- Оперативные сроки поставки под заказ (от 5 рабочих дней);
- Экспресс доставка в любую точку России;
- Техническая поддержка проекта, помощь в подборе аналогов, поставка прототипов;
- Система менеджмента качества сертифицирована по Международному стандарту ISO 9001;
- Лицензия ФСБ на осуществление работ с использованием сведений, составляющих государственную тайну;
- Поставка специализированных компонентов (Xilinx, Altera, Analog Devices, Intersil, Interpoint, Microsemi, Aeroflex, Peregrine, Syfer, Eurofarad, Texas Instrument, Miteq, Cobham, E2V, MA-COM, Hittite, Mini-Circuits, General Dynamics и др.);

Помимо этого, одним из направлений компании «ЭлектроПласт» является направление «Источники питания». Мы предлагаем Вам помощь Конструкторского отдела:

- Подбор оптимального решения, техническое обоснование при выборе компонента;
- Подбор аналогов;
- Консультации по применению компонента;
- Поставка образцов и прототипов;
- Техническая поддержка проекта;
- Защита от снятия компонента с производства.



#### Как с нами связаться

**Телефон:** 8 (812) 309 58 32 (многоканальный)

**Факс:** 8 (812) 320-02-42

**Электронная почта:** [org@eplast1.ru](mailto:org@eplast1.ru)

**Адрес:** 198099, г. Санкт-Петербург, ул. Калинина, дом 2, корпус 4, литера А.