



NPN SILICON RF TRANSISTOR NE664M04 / 2SC5754

NPN SILICON RF TRANSISTOR FOR MEDIUM OUTPUT POWER AMPLIFICATION (0.4 W) FLAT-LEAD 4-PIN THIN-TYPE SUPER MINIMOLD

FEATURES

- Ideal for 460 MHz to 2.4 GHz medium output power amplification
- $P_{O(1\text{ dB})} = 26.0\text{ dBm TYP. @ } V_{CE} = 3.6\text{ V, } f = 1.8\text{ GHz, } P_{in} = 15\text{ dBm}$
- High collector efficiency: $\eta_c = 60\%$
- UHS0-HV technology ($f_T = 25\text{ GHz}$) adopted
- High reliability through use of gold electrodes
- Flat-lead 4-pin thin-type super minimold package

ORDERING INFORMATION

Part Number	Quantity	Supplying Form
NE664M04-A 2SC5754-A	50 pcs (Non reel)	• 8 mm wide embossed taping
NE664M04-T2-A 2SC5754-T2-A	3 kpcs/reel	• Pin 1 (Emitter), Pin 2 (Collector) face the perforation side of the tape

Remark To order evaluation samples, contact your nearby sales office.
The unit sample quantity is 50 pcs.

Caution: Observe precautions when handling because these devices are sensitive to electrostatic discharge

The information in this document is subject to change without notice. Before using this document, please confirm that this is the latest version.

ABSOLUTE MAXIMUM RATINGS (T_A = +25°C)

Parameter	Symbol	Ratings	Unit
Collector to Base Voltage	V _{CBO}	13	V
Collector to Emitter Voltage	V _{CEO}	5.0	V
Emitter to Base Voltage	V _{EBO}	1.5	V
Collector Current	I _c	500	mA
Total Power Dissipation	P _{tot} ^{Note}	735	mW
Junction Temperature	T _j	150	°C
Storage Temperature	T _{stg}	-65 to +150	°C

Note Mounted on 38 × 38 mm, t = 0.4 mm polyimide PCB

THERMAL RESISTANCE

Parameter	Symbol	Test Conditions	Ratings	Unit
Junction to Ambient Resistance	R _{th j-a1}	Mounted on 38 × 38 mm, t = 0.4 mm polyimide PCB	130	°C/W
	R _{th j-a2}	Stand alone device in free air	570	°C/W

ELECTRICAL CHARACTERISTICS (T_A = +25°C)

Parameter	Symbol	Test Conditions	MIN.	TYP.	MAX.	Unit
DC Characteristics						
Collector Cut-off Current	I _{CB0}	V _{CB} = 5 V, I _E = 0 mA	–	–	1 000	nA
Emitter Cut-off Current	I _{EB0}	V _{BE} = 1 V, I _C = 0 mA	–	–	1 000	nA
DC Current Gain	h _{FE} ^{Note 1}	V _{CE} = 3 V, I _C = 100 mA	40	60	100	–
RF Characteristics						
Gain Bandwidth Product	f _T	V _{CE} = 3 V, I _C = 100 mA, f = 0.5 GHz	16	20	–	GHz
Insertion Power Gain	S _{21e} ²	V _{CE} = 3 V, I _C = 100 mA, f = 2 GHz	5.0	6.5	–	dB
Reverse Transfer Capacitance	C _{re} ^{Note 2}	V _{CB} = 3 V, I _E = 0 mA, f = 1 MHz	–	1.0	1.5	pF
Maximum Available Power Gain	MAG ^{Note 3}	V _{CE} = 3 V, I _C = 100 mA, f = 2 GHz	–	12.0	–	dB
Linear Gain	G _L	V _{CE} = 3.6 V, I _{Cq} = 20 mA, f = 1.8 GHz, P _{in} = 0 dBm, 1/2 Duty	–	12.0	–	dB
Gain 1 dB Compression Output Power	P _{O(1 dB)}	V _{CE} = 3.6 V, I _{Cq} = 4 mA, f = 1.8 GHz, P _{in} = 15 dBm, 1/2 Duty	–	26.0	–	dBm
Collector Efficiency	η _C	V _{CE} = 3.6 V, I _{Cq} = 4 mA, f = 1.8 GHz, P _{in} = 15 dBm, 1/2 Duty	–	60	–	%

- Notes**
1. Pulse measurement: PW ≤ 350 μs, Duty Cycle ≤ 2%
 2. Collector to base capacitance when the emitter grounded
 3. $MAG = \left| \frac{S_{21}}{S_{12}} \right| (K - \sqrt{K^2 - 1})$

h_{FE} CLASSIFICATION

Rank	FB
Marking	R57
h _{FE} Value	40 to 100

● TYPICAL CHARACTERISTICS (Unless otherwise specified, $T_A = +25^\circ\text{C}$)

TOTAL POWER DISSIPATION vs. AMBIENT TEMPERATURE

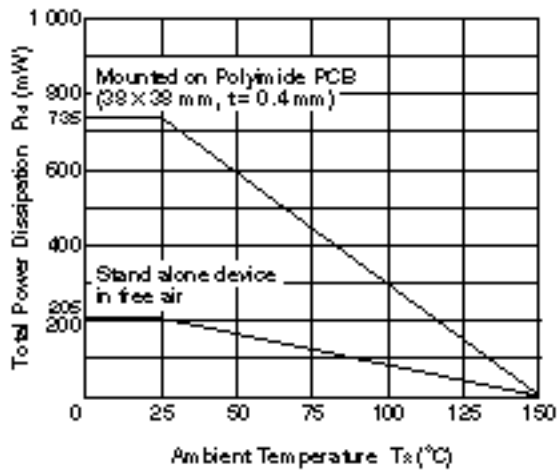

REVERSE TRANSFER CAPACITANCE vs. COLLECTOR TO BASE VOLTAGE

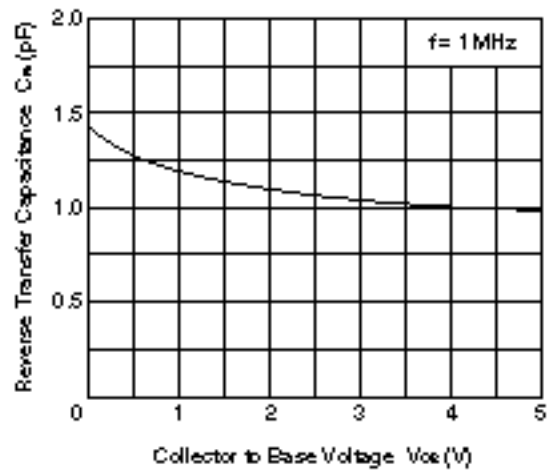

COLLECTOR CURRENT vs. BASE TO EMITTER VOLTAGE

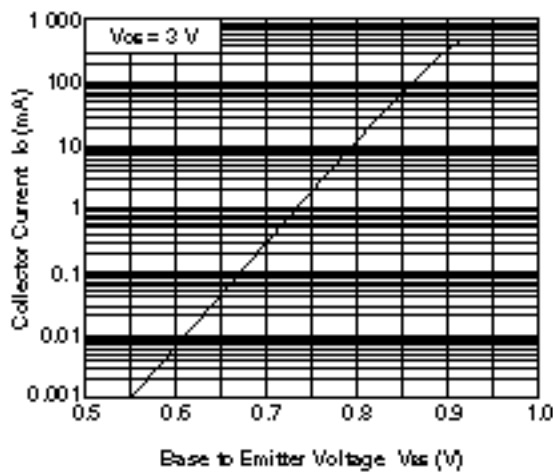

COLLECTOR CURRENT vs. COLLECTOR TO EMITTER VOLTAGE

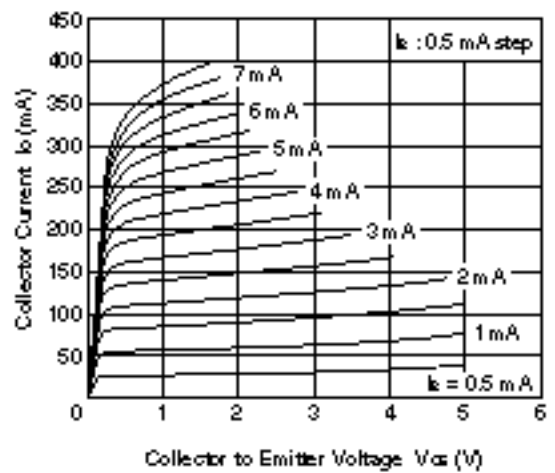

DC CURRENT GAIN vs. COLLECTOR CURRENT

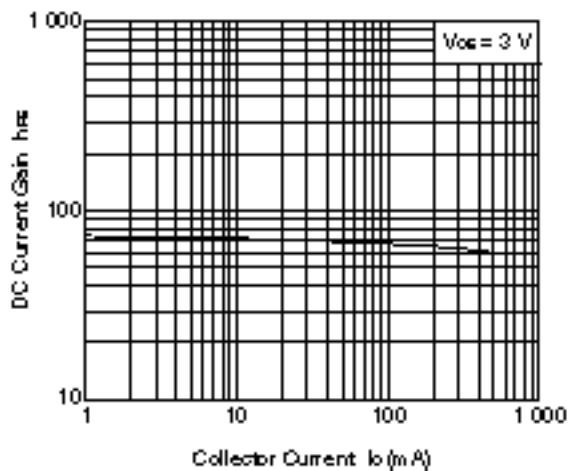

GAIN BANDWIDTH PRODUCT vs. COLLECTOR CURRENT

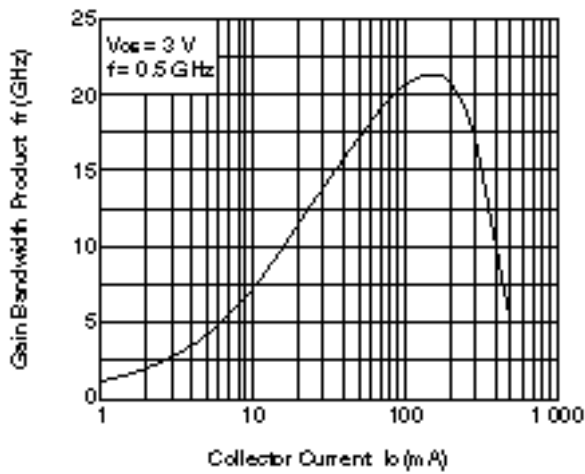

INSERTION POWER GAIN, MAG, MSG vs. FREQUENCY

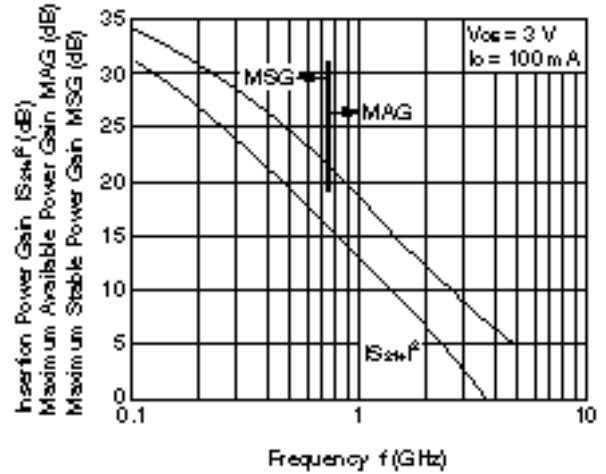

INSERTION POWER GAIN, MAG, MSG vs. COLLECTOR CURRENT

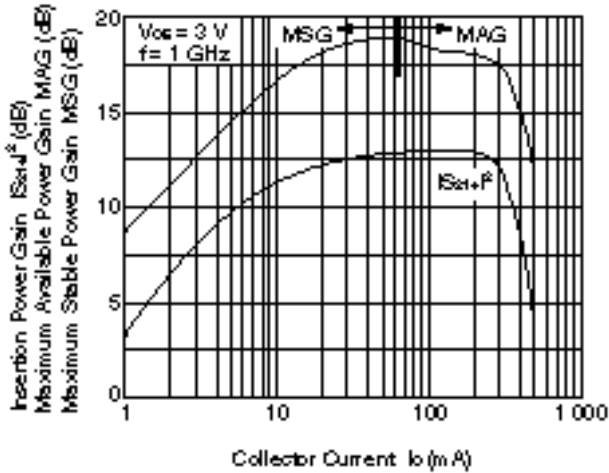

INSERTION POWER GAIN, MAG, MSG vs. COLLECTOR CURRENT

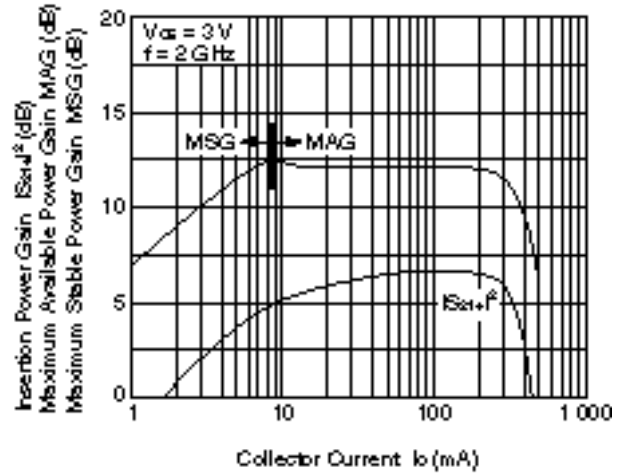

INSERTION POWER GAIN, MAG, MSG vs. COLLECTOR CURRENT

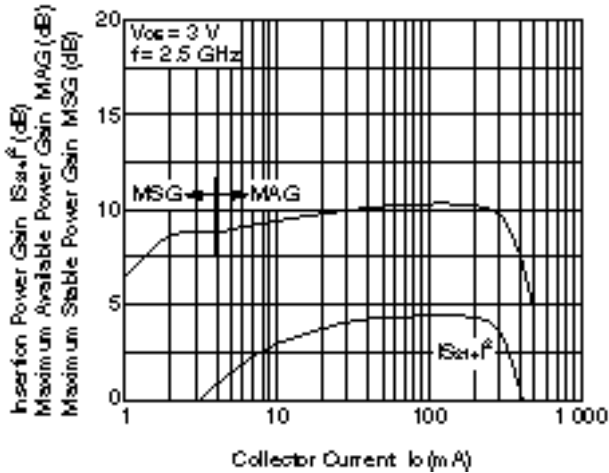

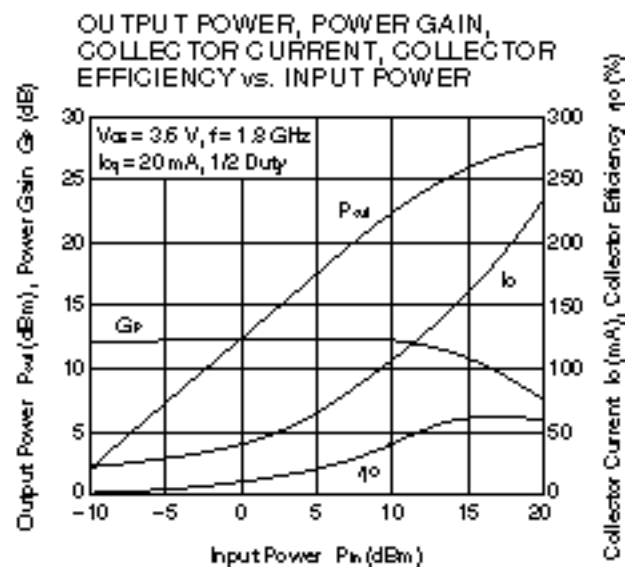
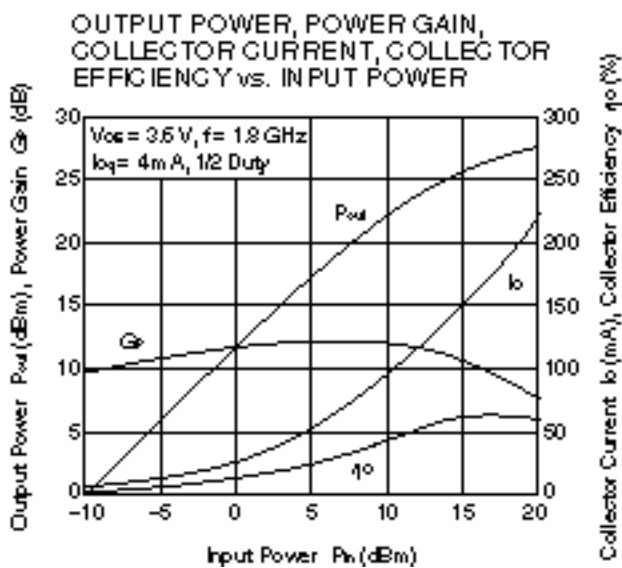
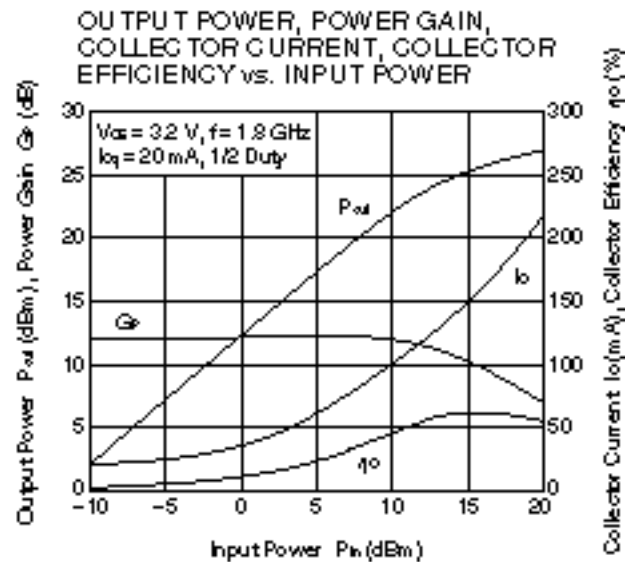
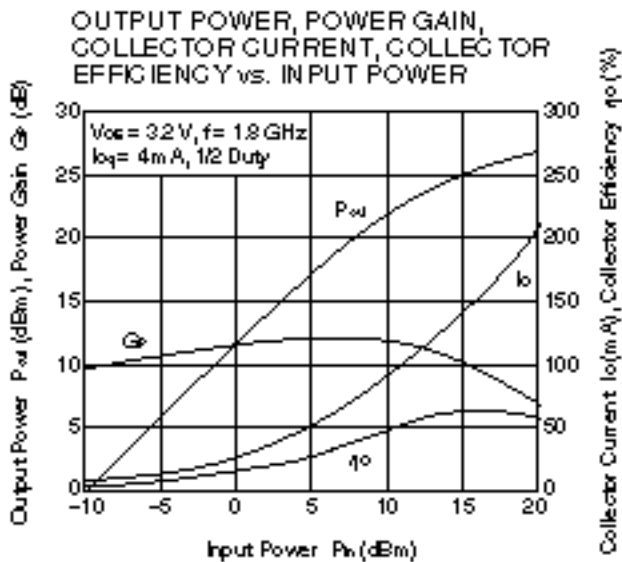
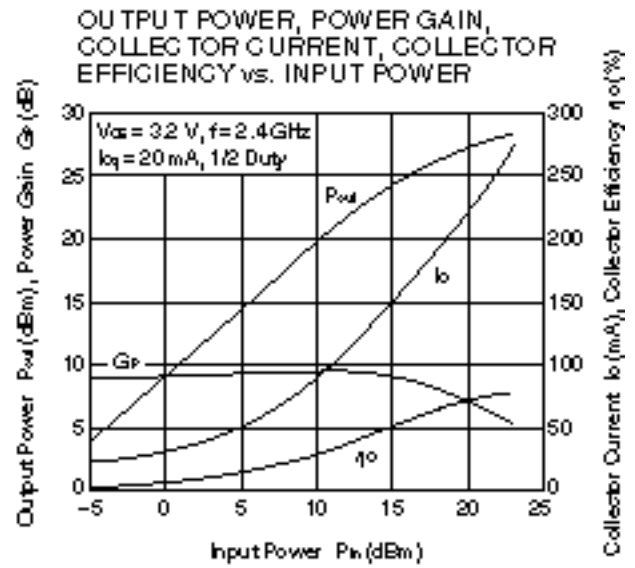
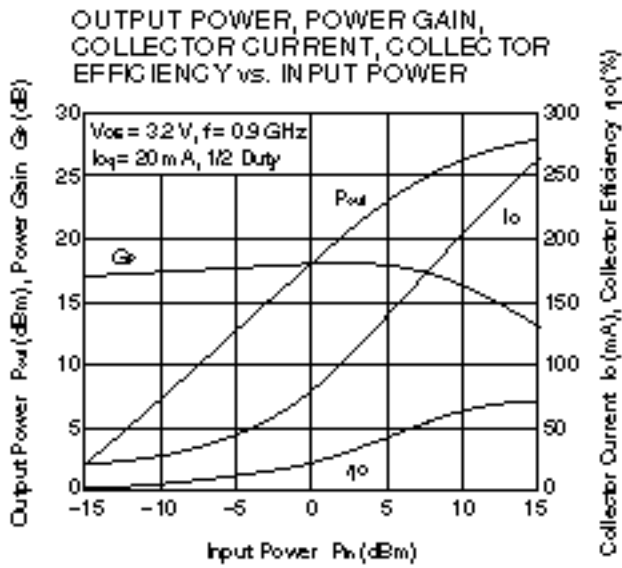

Remark The graphs indicate nominal characteristics.

POWER SUPPLY IMPEDANCE, LOAD IMPEDANCE (Recommended value)

Frequency f (GHz)	Collector to Emitter Voltage V_{CE} (V)	Supply Impedance Z_s (Ω)	Load Impedance Z_L (Ω)
0.9	2.8 to 3.6	8.4 – 5.2 j	15.1 – 4.3 j
1.8	2.8 to 3.6	6.3 – 16.4 j	15.8 – 6.9 j
2.4	2.8 to 3.6	5.9 – 22.1 j	15.2 – 17.9 j

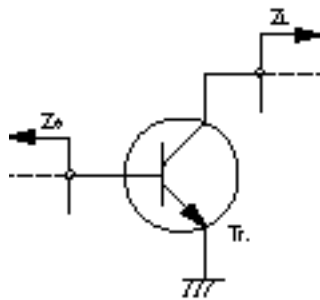

f = 0.9 GHz

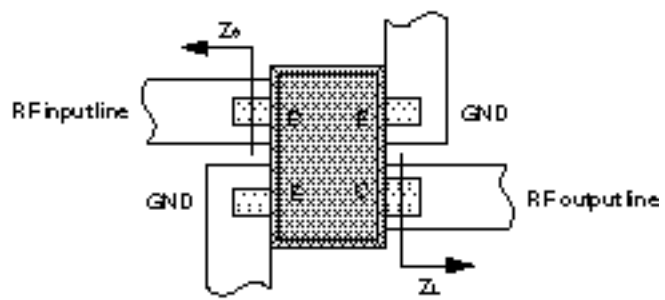
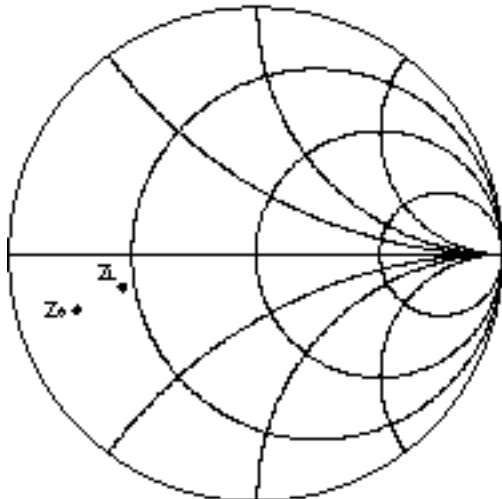

f = 1.8 GHz

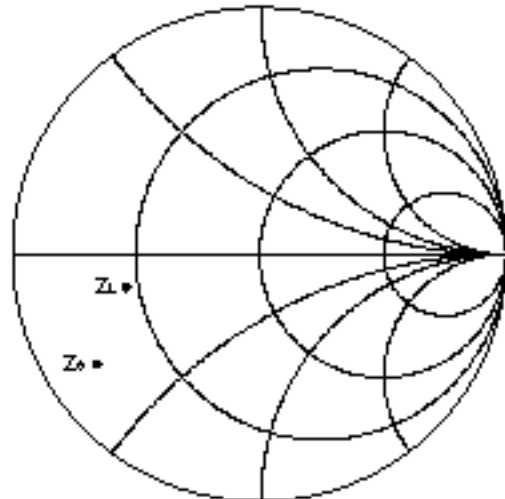

f = 2.4 GHz

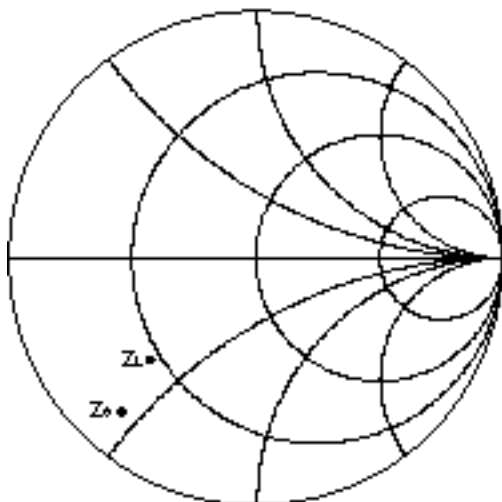

APPLICATION EXAMPLE (Low-cost PA solution)

Bluetooth Power Class 1
f = 2.4 GHz

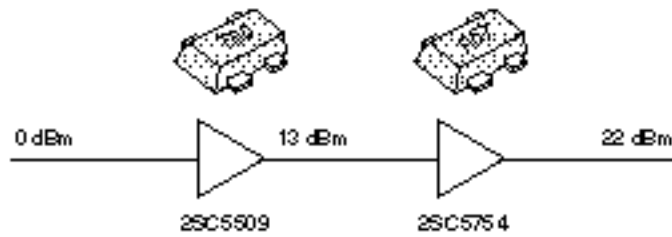

SS Cordless Phone
f = 2.4 GHz

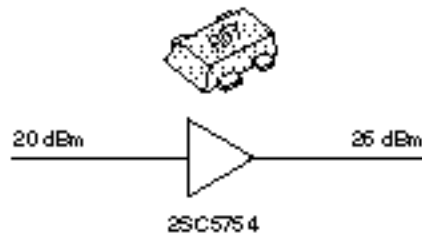

DCS1800 (GSM1800) Cellular Phone
f = 1.8 GHz

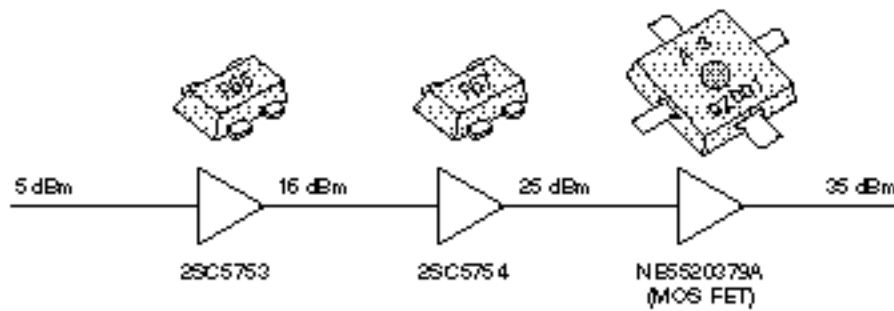

Cordless Phone
f = 0.9 GHz

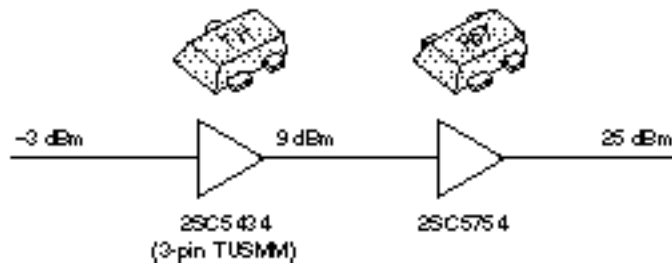

EVALUATION CIRCUIT EXAMPLE : 1.8 GHz PA EVALUATION BOARD

PCB Pattern and Element Layout

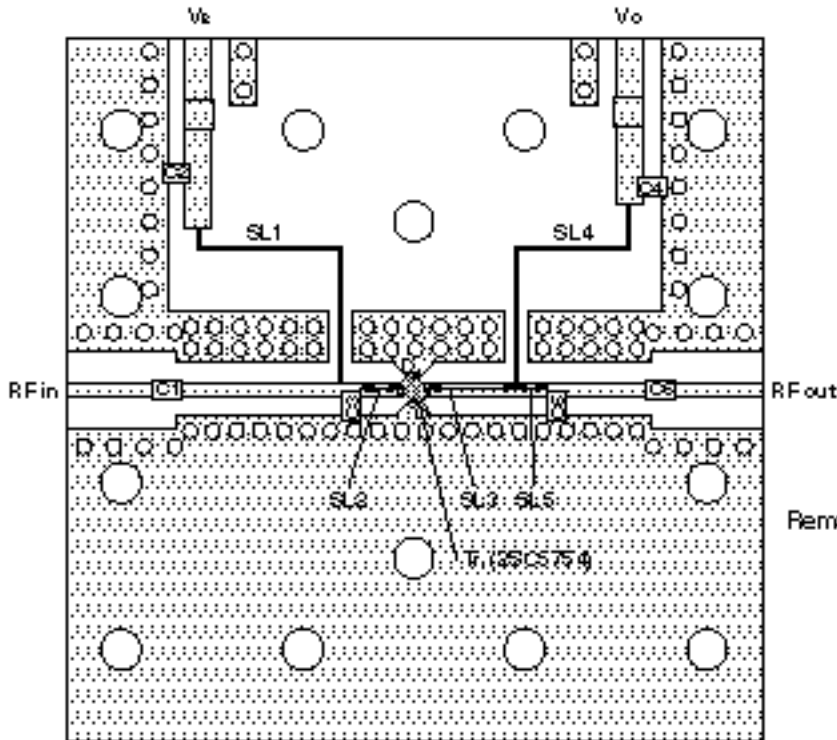

- Remarks
1. 38 × 38 mm, t=0.4 mm, ε= 4.55 double-sided copper-clad polyimide board
 2. Back side : GND pattern
 3. Solderplating on pattern
 4. ∅: Through holes

Equivalent Circuit

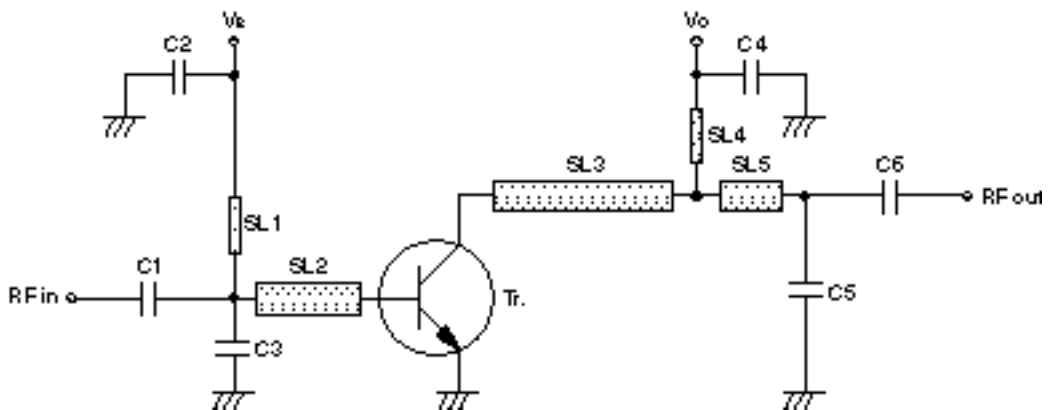

Parts List

Parts	Value	Size	Classification
C1, C6	18 pF		Multilayer ceramic chip capacitor
C2	3 300 pF		Multilayer ceramic chip capacitor
C3	3 pF		Multilayer ceramic chip capacitor
C4	15 pF		Multilayer ceramic chip capacitor
C5	1.5 pF		Multilayer ceramic chip capacitor
SL1, SL4		w = 0.20 mm	Strip line
SL2		w = 0.76 mm, l = 2.5 mm	Strip line
SL3		w = 0.76 mm, l = 5 mm	Strip line
SL5		w = 0.76 mm, l = 1.5 mm	Strip line

EXAMPLE OF CHARACTERISTICS FOR 1.8 GHz PA EVALUATION BOARD

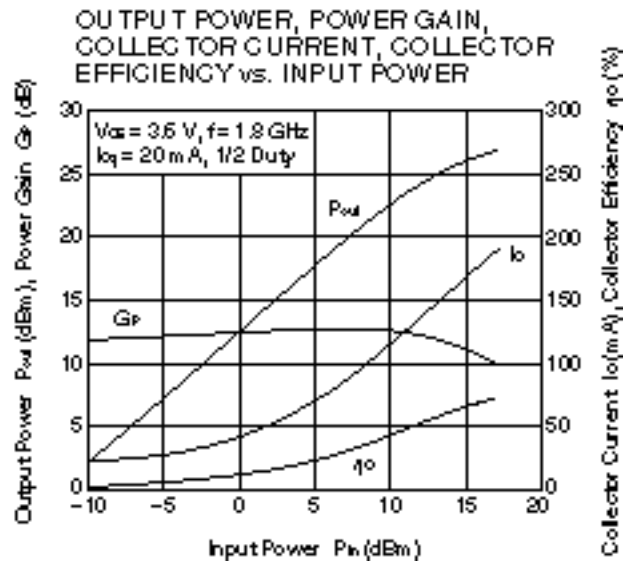
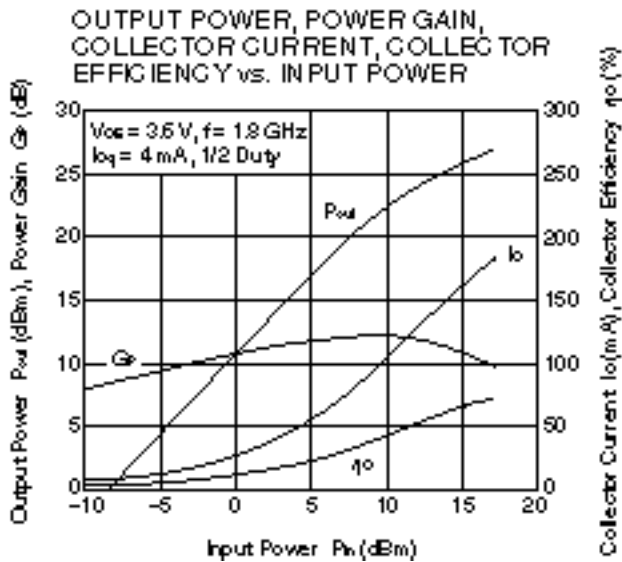
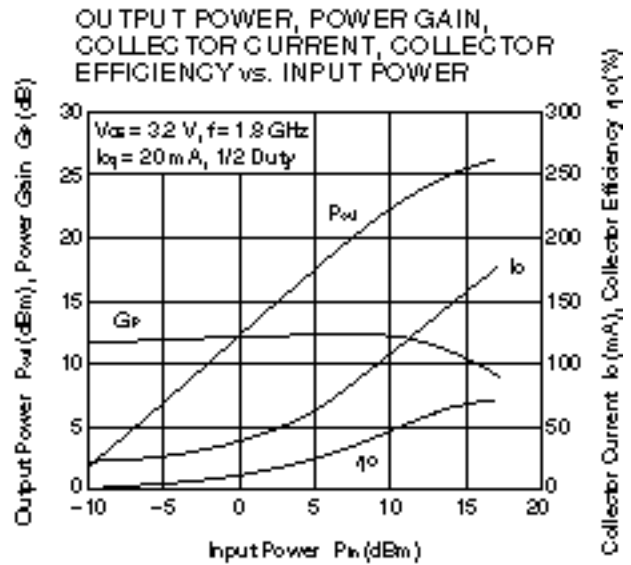
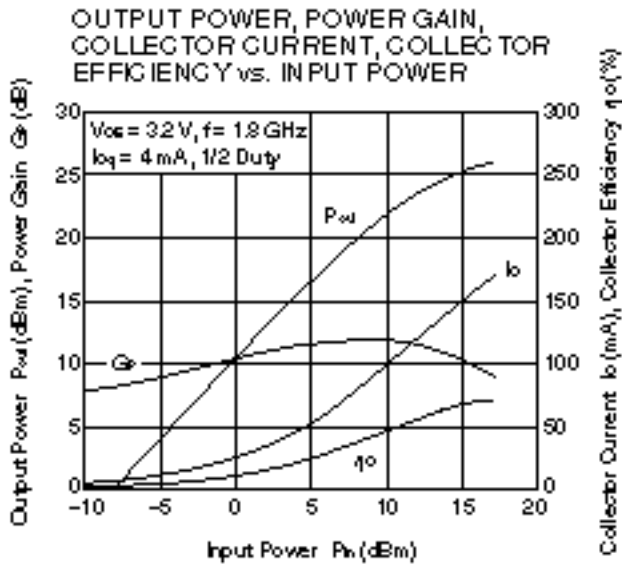

Remark The graphs indicate nominal characteristics.

S-PARAMETERS

Note When $K \geq 1$, the MAG (Maximum Available Power Gain) is used. $MAG = \left| \frac{S_{21}}{S_{12}} \right| (K - \sqrt{K^2 - 1})$

When $K < 1$, the MSG (Maximum Stable Power Gain) is used. $MSG = \left| \frac{S_{21}}{S_{12}} \right|$

$V_{CE} = 3 \text{ V}$, $I_c = 4 \text{ mA}$, $Z_o = 50 \Omega$

Frequency (GHz)	S ₁₁		S ₂₁		S ₁₂		S ₂₂		K	MAG/MSG ^{Note} (dB)
	MAG.	ANG. (deg.)	MAG.	ANG. (deg.)	MAG.	ANG. (deg.)	MAG.	ANG. (deg.)		
0.1	0.771	-53.6	10.332	152.8	0.054	61.7	0.748	-36.2	0.113	22.82
0.2	0.777	-90.9	10.223	129.7	0.093	42.6	0.721	-52.4	0.176	20.41
0.3	0.777	-115.1	7.903	117.3	0.105	32.1	0.574	-71.3	0.169	18.75
0.4	0.787	-131.9	6.419	107.5	0.113	23.9	0.477	-84.5	0.198	17.55
0.5	0.784	-144.3	5.324	99.3	0.117	18.5	0.407	-95.0	0.251	16.58
0.6	0.790	-153.9	4.575	92.5	0.119	14.4	0.364	-104.1	0.284	15.84
0.7	0.799	-161.2	3.971	87.3	0.120	11.1	0.332	-112.5	0.317	15.18
0.8	0.803	-167.5	3.507	82.2	0.121	8.3	0.311	-119.3	0.353	14.62
0.9	0.806	-172.9	3.131	77.7	0.121	6.1	0.293	-126.5	0.395	14.15
1.0	0.808	-177.5	2.835	73.7	0.120	4.4	0.281	-132.1	0.438	13.72
1.1	0.806	178.4	2.567	69.9	0.120	2.7	0.276	-138.4	0.494	13.32
1.2	0.809	174.9	2.359	66.2	0.119	1.5	0.270	-143.6	0.535	12.98
1.3	0.814	171.8	2.185	62.9	0.118	0.1	0.273	-148.0	0.564	12.68
1.4	0.817	168.4	2.030	59.7	0.117	-1.0	0.272	-152.7	0.602	12.38
1.5	0.821	165.4	1.895	56.4	0.116	-1.9	0.274	-156.4	0.637	12.11
1.6	0.819	162.5	1.776	53.3	0.115	-2.9	0.277	-161.1	0.698	11.87
1.7	0.821	159.8	1.669	50.2	0.114	-3.6	0.280	-164.7	0.741	11.64
1.8	0.826	156.9	1.577	46.9	0.113	-4.2	0.289	-168.8	0.767	11.44
1.9	0.823	154.5	1.490	44.1	0.112	-4.7	0.294	-171.9	0.837	11.25
2.0	0.830	151.3	1.415	40.9	0.111	-5.2	0.303	-174.9	0.849	11.04
2.1	0.832	148.8	1.338	37.7	0.110	-5.6	0.309	-178.1	0.894	10.85
2.2	0.837	146.2	1.280	35.0	0.109	-5.6	0.317	178.9	0.923	10.71
2.3	0.835	143.6	1.218	32.2	0.107	-5.8	0.328	175.7	0.995	10.56
2.4	0.836	141.2	1.160	29.5	0.106	-5.8	0.338	173.2	1.046	9.07
2.5	0.843	138.7	1.109	26.6	0.105	-5.7	0.352	170.6	1.047	8.90
2.6	0.845	136.5	1.052	24.1	0.105	-5.8	0.360	169.0	1.092	8.16
2.7	0.850	134.1	1.004	21.4	0.106	-5.9	0.372	166.5	1.101	7.84
2.8	0.852	132.2	0.960	19.0	0.105	-6.0	0.379	164.4	1.144	7.32
2.9	0.860	130.5	0.914	16.4	0.103	-6.1	0.390	162.1	1.151	7.12
3.0	0.863	128.8	0.879	14.1	0.101	-6.0	0.398	159.9	1.188	6.75
4.0	0.876	117.1	0.622	-3.2	0.104	2.4	0.494	140.8	1.482	3.68
5.0	0.902	102.8	0.461	-20.4	0.117	0.2	0.624	125.0	1.296	2.69

$V_{CE} = 3\text{ V}$, $I_C = 10\text{ mA}$, $Z_0 = 50\ \Omega$

Frequency (GHz)	S ₁₁		S ₂₁		S ₁₂		S ₂₂		K	MAG/MSG (dB)
	MAG.	ANG. (deg.)	MAG.	ANG. (deg.)	MAG.	ANG. (deg.)	MAG.	ANG. (deg.)		
0.1	0.658	-82.1	19.246	142.9	0.041	51.9	0.692	-60.8	0.161	26.72
0.2	0.708	-127.0	15.736	118.5	0.061	35.9	0.584	-89.6	0.246	24.10
0.3	0.750	-145.1	11.390	107.0	0.065	27.9	0.509	-113.3	0.270	22.41
0.4	0.769	-156.9	8.892	99.2	0.068	23.4	0.463	-129.5	0.335	21.14
0.5	0.777	-165.2	7.166	93.0	0.070	21.4	0.435	-141.6	0.409	20.11
0.6	0.782	-171.8	6.060	87.6	0.072	20.4	0.425	-150.7	0.473	19.26
0.7	0.796	-176.7	5.232	83.5	0.074	19.8	0.419	-158.3	0.518	18.51
0.8	0.800	179.2	4.586	79.4	0.075	19.5	0.414	-164.2	0.570	17.85
0.9	0.801	175.2	4.078	75.8	0.076	19.5	0.414	-169.9	0.634	17.29
1.0	0.805	171.9	3.676	72.6	0.078	19.5	0.412	-174.5	0.680	16.74
1.1	0.805	168.8	3.326	69.6	0.079	19.6	0.418	-178.8	0.738	16.23
1.2	0.810	166.0	3.044	66.4	0.081	19.7	0.419	177.2	0.773	15.75
1.3	0.811	163.6	2.817	63.5	0.083	19.9	0.424	174.3	0.810	15.31
1.4	0.814	161.0	2.611	60.8	0.085	20.0	0.427	170.9	0.846	14.89
1.5	0.818	158.4	2.431	58.2	0.087	20.0	0.429	168.2	0.875	14.49
1.6	0.816	156.0	2.276	55.6	0.088	19.7	0.436	164.9	0.919	14.11
1.7	0.819	153.6	2.134	52.8	0.090	19.7	0.440	162.3	0.948	13.74
1.8	0.822	151.1	2.014	50.0	0.092	19.6	0.449	159.7	0.968	13.40
1.9	0.821	149.1	1.900	47.7	0.094	19.4	0.453	157.3	1.001	12.81
2.0	0.829	146.3	1.798	44.7	0.096	19.2	0.459	155.2	1.004	12.32
2.1	0.832	144.0	1.697	42.2	0.098	18.9	0.464	152.9	1.029	11.35
2.2	0.836	141.7	1.622	39.5	0.100	18.7	0.470	150.8	1.034	10.98
2.3	0.833	139.3	1.549	37.2	0.102	18.4	0.480	148.6	1.073	10.19
2.4	0.836	137.1	1.473	35.1	0.103	17.8	0.487	146.8	1.091	9.72
2.5	0.842	134.7	1.404	32.6	0.105	17.3	0.497	145.0	1.088	9.45
2.6	0.844	132.8	1.332	30.5	0.107	16.7	0.499	143.5	1.104	8.99
2.7	0.847	130.5	1.267	28.0	0.109	16.0	0.509	141.8	1.112	8.61
2.8	0.852	128.8	1.211	26.1	0.110	15.5	0.514	140.1	1.121	8.29
2.9	0.858	127.3	1.155	23.7	0.111	15.0	0.522	138.6	1.119	8.09
3.0	0.862	125.9	1.111	21.8	0.111	14.6	0.525	136.7	1.128	7.82
4.0	0.870	115.0	0.801	6.2	0.128	12.2	0.579	121.3	1.236	5.04
5.0	0.894	101.2	0.609	-10.4	0.141	3.3	0.660	110.5	1.161	3.92

$V_{CE} = 3\text{ V}$, $I_C = 20\text{ mA}$, $Z_O = 50\ \Omega$

Frequency (GHz)	S ₁₁		S ₂₁		S ₁₂		S ₂₂		K	MAG/MSG (dB)
	MAG.	ANG. (deg.)	MAG.	ANG. (deg.)	MAG.	ANG. (deg.)	MAG.	ANG. (deg.)		
0.1	0.617	-113.5	26.805	134.3	0.029	48.5	0.657	-83.2	0.235	29.60
0.2	0.715	-149.3	18.809	111.7	0.041	34.8	0.573	-117.3	0.351	26.64
0.3	0.763	-161.5	13.211	101.4	0.043	30.7	0.544	-137.8	0.410	24.87
0.4	0.777	-169.8	10.147	94.9	0.046	30.0	0.530	-151.1	0.508	23.45
0.5	0.786	-175.7	8.126	89.7	0.048	30.9	0.519	-160.5	0.603	22.30
0.6	0.788	179.5	6.815	85.0	0.051	32.0	0.519	-167.4	0.678	21.28
0.7	0.797	175.7	5.858	81.6	0.054	32.8	0.520	-173.2	0.735	20.37
0.8	0.804	172.4	5.119	77.9	0.057	33.6	0.519	-177.7	0.779	19.55
0.9	0.804	169.2	4.548	74.8	0.059	34.5	0.523	178.0	0.834	18.84
1.0	0.809	166.7	4.094	72.0	0.063	35.2	0.522	174.3	0.868	18.16
1.1	0.807	164.2	3.703	69.3	0.066	35.4	0.530	170.9	0.909	17.50
1.2	0.813	161.8	3.386	66.4	0.069	35.6	0.532	167.6	0.930	16.91
1.3	0.815	159.6	3.132	63.7	0.073	35.7	0.536	165.0	0.946	16.34
1.4	0.817	157.3	2.898	61.4	0.076	35.5	0.539	162.2	0.970	15.82
1.5	0.821	155.1	2.696	58.9	0.079	35.3	0.541	159.6	0.984	15.32
1.6	0.818	152.9	2.522	56.5	0.083	34.6	0.547	157.0	1.008	14.29
1.7	0.822	150.6	2.362	54.0	0.086	34.4	0.550	154.6	1.022	13.49
1.8	0.827	148.6	2.226	51.4	0.089	33.5	0.559	152.3	1.021	13.10
1.9	0.823	146.4	2.104	49.2	0.092	33.0	0.561	150.2	1.046	12.26
2.0	0.834	143.9	1.988	46.5	0.095	32.3	0.567	148.1	1.035	12.05
2.1	0.834	141.5	1.872	44.0	0.099	31.5	0.571	146.0	1.051	11.41
2.2	0.837	139.5	1.787	41.7	0.101	30.7	0.575	144.1	1.057	11.02
2.3	0.836	137.2	1.706	39.6	0.104	29.9	0.585	142.0	1.071	10.52
2.4	0.840	135.2	1.621	37.6	0.106	28.9	0.589	140.4	1.077	10.16
2.5	0.844	133.0	1.546	35.3	0.109	27.6	0.600	138.6	1.076	9.84
2.6	0.848	131.1	1.464	33.4	0.112	26.7	0.601	137.3	1.079	9.46
2.7	0.852	129.0	1.397	31.1	0.114	25.6	0.609	135.6	1.078	9.17
2.8	0.855	127.2	1.333	29.3	0.115	24.7	0.612	134.0	1.087	8.82
2.9	0.863	125.8	1.271	27.2	0.117	24.1	0.618	132.6	1.081	8.63
3.0	0.865	124.3	1.222	25.2	0.118	23.4	0.622	130.8	1.088	8.34
4.0	0.871	114.0	0.884	10.9	0.139	16.7	0.661	115.4	1.147	5.71
5.0	0.896	100.5	0.677	-4.5	0.152	5.8	0.717	105.1	1.103	4.54

$V_{CE} = 3\text{ V}$, $I_C = 50\text{ mA}$, $Z_O = 50\ \Omega$

Frequency (GHz)	S ₁₁		S ₂₁		S ₁₂		S ₂₂		K	MAG/MSG (dB)
	MAG.	ANG. (deg.)	MAG.	ANG. (deg.)	MAG.	ANG. (deg.)	MAG.	ANG. (deg.)		
0.1	0.647	-145.2	33.598	125.4	0.019	44.0	0.648	-104.5	0.368	32.46
0.2	0.755	-168.0	21.218	106.4	0.025	42.8	0.610	-139.3	0.572	29.32
0.3	0.781	-174.3	14.535	97.1	0.027	42.6	0.602	-154.7	0.663	27.25
0.4	0.793	-179.5	11.079	91.6	0.031	45.3	0.602	-164.6	0.764	25.57
0.5	0.795	176.7	8.817	87.3	0.035	47.4	0.599	-171.6	0.842	24.04
0.6	0.796	173.1	7.381	83.2	0.039	49.4	0.604	-176.8	0.895	22.76
0.7	0.806	170.3	6.312	80.2	0.043	50.4	0.605	178.7	0.925	21.62
0.8	0.808	167.5	5.525	76.8	0.048	50.7	0.606	175.0	0.947	20.62
0.9	0.810	165.1	4.893	74.0	0.052	50.9	0.611	171.6	0.971	19.73
1.0	0.814	162.9	4.391	71.4	0.056	50.8	0.611	168.5	0.985	18.91
1.1	0.810	160.6	3.984	69.2	0.061	50.7	0.619	165.7	1.008	17.63
1.2	0.812	158.6	3.642	66.4	0.065	50.2	0.621	162.7	1.017	16.67
1.3	0.816	156.7	3.366	63.9	0.070	49.3	0.625	160.4	1.017	16.04
1.4	0.820	154.7	3.112	61.7	0.074	48.4	0.627	157.9	1.021	15.35
1.5	0.822	152.7	2.893	59.4	0.078	47.4	0.629	155.6	1.027	14.67
1.6	0.822	150.5	2.707	57.2	0.082	46.2	0.635	153.2	1.035	14.02
1.7	0.826	148.7	2.533	54.9	0.086	45.3	0.638	151.0	1.037	13.49
1.8	0.827	146.5	2.385	52.4	0.090	43.9	0.646	148.8	1.040	13.00
1.9	0.828	144.6	2.252	50.3	0.094	42.8	0.647	146.7	1.047	12.47
2.0	0.836	142.2	2.123	47.7	0.098	41.5	0.652	144.8	1.039	12.16
2.1	0.838	140.1	2.003	45.5	0.101	40.2	0.655	142.8	1.044	11.67
2.2	0.841	138.0	1.907	43.4	0.104	39.1	0.657	140.9	1.047	11.28
2.3	0.840	135.8	1.822	41.3	0.108	37.7	0.668	139.0	1.054	10.87
2.4	0.842	133.8	1.731	39.4	0.110	36.3	0.670	137.4	1.060	10.48
2.5	0.849	131.7	1.650	37.2	0.113	34.7	0.680	135.7	1.053	10.24
2.6	0.850	129.9	1.562	35.5	0.116	33.4	0.680	134.4	1.060	9.79
2.7	0.854	127.8	1.485	33.4	0.119	31.9	0.689	132.6	1.059	9.47
2.8	0.859	126.1	1.418	31.6	0.120	30.9	0.691	131.2	1.061	9.21
2.9	0.867	124.7	1.353	29.7	0.122	30.2	0.695	129.8	1.054	9.03
3.0	0.869	123.3	1.301	27.9	0.124	29.2	0.698	128.1	1.059	8.74
4.0	0.875	113.3	0.939	14.6	0.147	19.9	0.730	112.8	1.093	6.20
5.0	0.900	99.8	0.719	-0.1	0.159	8.1	0.772	102.7	1.067	4.99

$V_{CE} = 3\text{ V}$, $I_C = 100\text{ mA}$, $Z_0 = 50\ \Omega$

Frequency (GHz)	S ₁₁		S ₂₁		S ₁₂		S ₂₂		K	MAG/MSG (dB)
	MAG.	ANG. (deg.)	MAG.	ANG. (deg.)	MAG.	ANG. (deg.)	MAG.	ANG. (deg.)		
0.1	0.693	-161.1	36.699	121.5	0.014	58.0	0.629	-118.6	0.633	34.23
0.2	0.777	-174.9	22.046	104.6	0.018	50.1	0.633	-147.6	0.722	30.88
0.3	0.790	-179.4	15.005	95.4	0.023	53.9	0.624	-160.6	0.820	28.23
0.4	0.801	176.7	11.384	90.5	0.027	55.4	0.629	-169.1	0.885	26.32
0.5	0.801	173.7	9.034	86.5	0.031	57.8	0.629	-175.3	0.942	24.61
0.6	0.800	170.4	7.543	82.5	0.036	58.8	0.633	-179.9	0.973	23.18
0.7	0.811	168.2	6.460	79.6	0.041	59.0	0.636	176.1	0.980	21.95
0.8	0.813	165.9	5.645	76.5	0.046	58.6	0.635	172.7	0.992	20.89
0.9	0.813	163.7	5.006	73.7	0.051	58.2	0.642	169.6	1.004	19.53
1.0	0.817	161.6	4.499	71.3	0.056	57.7	0.642	166.6	1.011	18.44
1.1	0.813	159.5	4.066	68.9	0.060	56.8	0.650	164.0	1.025	17.32
1.2	0.816	157.4	3.718	66.4	0.065	55.7	0.651	161.2	1.029	16.55
1.3	0.820	155.7	3.437	63.8	0.070	54.5	0.655	159.0	1.026	15.95
1.4	0.822	153.6	3.175	61.8	0.074	53.2	0.658	156.5	1.030	15.24
1.5	0.826	151.8	2.954	59.5	0.079	51.9	0.659	154.3	1.031	14.68
1.6	0.825	149.6	2.763	57.3	0.083	50.3	0.666	151.9	1.035	14.08
1.7	0.829	147.9	2.581	55.0	0.087	49.4	0.667	149.8	1.037	13.54
1.8	0.830	145.9	2.436	52.6	0.091	47.6	0.674	147.7	1.038	13.09
1.9	0.830	144.0	2.292	50.7	0.095	46.4	0.676	145.7	1.044	12.54
2.0	0.838	141.7	2.164	48.1	0.099	44.8	0.679	143.8	1.038	12.21
2.1	0.842	139.5	2.038	45.9	0.103	43.3	0.683	141.8	1.039	11.77
2.2	0.843	137.5	1.944	43.8	0.106	42.0	0.685	140.0	1.041	11.40
2.3	0.842	135.3	1.854	41.8	0.109	40.4	0.695	138.2	1.048	10.97
2.4	0.845	133.2	1.762	40.0	0.112	38.9	0.698	136.5	1.050	10.62
2.5	0.851	131.3	1.675	37.8	0.115	37.2	0.706	134.9	1.045	10.35
2.6	0.854	129.4	1.589	36.1	0.118	35.7	0.706	133.6	1.047	9.97
2.7	0.856	127.4	1.512	34.1	0.121	34.1	0.715	131.9	1.049	9.62
2.8	0.863	125.7	1.442	32.3	0.122	33.2	0.716	130.4	1.049	9.37
2.9	0.868	124.4	1.376	30.5	0.124	32.3	0.721	129.0	1.048	9.13
3.0	0.873	122.9	1.324	28.7	0.125	31.2	0.724	127.3	1.046	8.93
4.0	0.874	113.0	0.954	15.7	0.149	21.2	0.754	112.1	1.081	6.33
5.0	0.898	99.6	0.731	1.5	0.161	9.1	0.793	102.0	1.063	5.03

$V_{CE} = 3\text{ V}$, $I_C = 150\text{ mA}$, $Z_O = 50\ \Omega$

Frequency (GHz)	S ₁₁		S ₂₁		S ₁₂		S ₂₂		K	MAG/MSG (dB)
	MAG.	ANG. (deg.)	MAG.	ANG. (deg.)	MAG.	ANG. (deg.)	MAG.	ANG. (deg.)		
0.1	0.716	-163.4	36.859	120.7	0.012	52.3	0.632	-121.0	0.611	34.91
0.2	0.788	-176.8	22.148	104.0	0.017	57.2	0.632	-150.7	0.801	31.13
0.3	0.799	179.3	15.025	95.0	0.021	58.1	0.627	-162.8	0.869	28.54
0.4	0.802	175.7	11.366	90.1	0.026	60.6	0.634	-170.8	0.933	26.48
0.5	0.803	172.5	9.013	86.0	0.031	61.8	0.634	-176.6	0.971	24.67
0.6	0.804	169.7	7.533	82.1	0.036	62.4	0.639	179.0	0.993	23.24
0.7	0.812	167.5	6.447	79.2	0.041	62.0	0.641	175.2	0.997	21.98
0.8	0.814	165.2	5.627	76.2	0.046	61.1	0.641	171.9	1.006	20.43
0.9	0.815	163.0	4.984	73.4	0.050	60.8	0.647	168.8	1.017	19.15
1.0	0.817	161.1	4.482	71.1	0.055	59.8	0.648	165.9	1.022	18.18
1.1	0.816	159.1	4.055	68.8	0.060	58.7	0.656	163.4	1.029	17.24
1.2	0.822	157.1	3.706	66.2	0.065	57.7	0.657	160.8	1.029	16.54
1.3	0.820	155.4	3.427	63.7	0.070	56.4	0.661	158.5	1.033	15.81
1.4	0.824	153.4	3.163	61.6	0.074	54.9	0.664	156.0	1.032	15.19
1.5	0.826	151.4	2.938	59.5	0.079	53.4	0.665	153.9	1.036	14.57
1.6	0.826	149.4	2.752	57.3	0.083	51.9	0.672	151.5	1.039	14.00
1.7	0.829	147.6	2.573	55.0	0.087	50.7	0.673	149.4	1.041	13.47
1.8	0.832	145.7	2.423	52.6	0.091	48.8	0.681	147.2	1.040	13.03
1.9	0.830	143.8	2.287	50.6	0.095	47.5	0.681	145.3	1.046	12.49
2.0	0.839	141.2	2.154	48.1	0.099	45.9	0.685	143.4	1.040	12.15
2.1	0.841	139.1	2.028	45.9	0.102	44.5	0.688	141.5	1.044	11.68
2.2	0.844	137.3	1.934	43.8	0.106	43.0	0.690	139.7	1.043	11.33
2.3	0.842	135.1	1.848	41.9	0.109	41.4	0.700	137.9	1.049	10.92
2.4	0.847	132.9	1.755	40.1	0.112	39.7	0.703	136.2	1.050	10.59
2.5	0.853	131.0	1.672	37.9	0.115	38.0	0.712	134.6	1.044	10.34
2.6	0.856	129.2	1.581	36.3	0.118	36.5	0.712	133.3	1.048	9.94
2.7	0.860	127.2	1.505	34.2	0.121	35.0	0.719	131.6	1.047	9.64
2.8	0.865	125.6	1.435	32.5	0.122	34.0	0.722	130.2	1.048	9.35
2.9	0.871	124.1	1.371	30.6	0.124	33.1	0.727	128.7	1.044	9.15
3.0	0.874	122.8	1.318	28.7	0.126	32.0	0.730	127.0	1.045	8.90
4.0	0.879	113.0	0.951	15.8	0.149	21.8	0.758	112.0	1.073	6.39
5.0	0.900	99.8	0.727	1.7	0.162	9.5	0.797	101.9	1.060	5.04

$V_{CE} = 3\text{ V}$, $I_C = 200\text{ mA}$, $Z_0 = 50\ \Omega$

Frequency (GHz)	S ₁₁		S ₂₁		S ₁₂		S ₂₂		K	MAG/MSG (dB)
	MAG.	ANG. (deg.)	MAG.	ANG. (deg.)	MAG.	ANG. (deg.)	MAG.	ANG. (deg.)		
0.1	0.715	-166.0	36.507	120.1	0.012	49.8	0.607	-121.9	0.629	34.77
0.2	0.801	-177.8	21.860	103.7	0.016	60.9	0.628	-152.6	0.840	31.31
0.3	0.801	178.2	14.764	94.7	0.020	61.4	0.625	-164.1	0.911	28.66
0.4	0.807	174.8	11.180	89.7	0.025	62.9	0.633	-171.8	0.955	26.52
0.5	0.804	172.2	8.871	86.0	0.030	64.0	0.633	-177.4	0.994	24.72
0.6	0.804	169.3	7.403	81.9	0.035	64.1	0.638	178.3	1.011	22.61
0.7	0.816	167.0	6.346	79.1	0.040	63.6	0.641	174.5	1.008	21.43
0.8	0.816	164.9	5.531	76.0	0.046	62.7	0.641	171.4	1.016	20.08
0.9	0.817	162.9	4.899	73.2	0.050	61.9	0.647	168.4	1.024	18.95
1.0	0.821	160.7	4.409	70.9	0.055	60.9	0.647	165.6	1.026	18.04
1.1	0.820	158.7	3.984	68.6	0.060	59.9	0.655	163.1	1.033	17.11
1.2	0.822	156.8	3.641	66.1	0.065	58.6	0.657	160.4	1.037	16.33
1.3	0.826	155.1	3.366	63.5	0.070	57.5	0.661	158.2	1.032	15.75
1.4	0.829	153.2	3.111	61.5	0.074	55.8	0.663	155.7	1.034	15.10
1.5	0.828	151.2	2.891	59.3	0.079	54.2	0.663	153.7	1.039	14.44
1.6	0.829	149.1	2.702	57.2	0.083	52.6	0.671	151.3	1.042	13.88
1.7	0.832	147.3	2.528	54.9	0.087	51.4	0.673	149.2	1.043	13.35
1.8	0.835	145.3	2.382	52.4	0.091	49.5	0.680	147.0	1.042	12.92
1.9	0.833	143.6	2.246	50.5	0.095	48.1	0.681	145.1	1.049	12.37
2.0	0.840	141.3	2.116	48.0	0.099	46.5	0.684	143.3	1.044	12.01
2.1	0.843	138.9	1.997	45.7	0.103	45.0	0.688	141.3	1.046	11.57
2.2	0.847	136.9	1.904	43.6	0.106	43.5	0.690	139.5	1.043	11.26
2.3	0.844	134.8	1.814	41.6	0.109	42.0	0.699	137.6	1.053	10.79
2.4	0.848	133.0	1.724	39.8	0.112	40.3	0.703	136.1	1.053	10.47
2.5	0.855	130.8	1.641	37.7	0.115	38.5	0.712	134.4	1.047	10.21
2.6	0.858	129.1	1.555	36.1	0.118	37.0	0.710	133.1	1.050	9.84
2.7	0.859	127.1	1.480	34.0	0.121	35.5	0.720	131.4	1.053	9.47
2.8	0.864	125.4	1.412	32.3	0.122	34.5	0.722	130.0	1.055	9.19
2.9	0.873	123.9	1.345	30.4	0.124	33.4	0.726	128.5	1.048	9.02
3.0	0.876	122.6	1.295	28.7	0.126	32.5	0.728	126.9	1.048	8.78
4.0	0.879	112.9	0.937	15.8	0.149	22.0	0.757	111.9	1.076	6.29
5.0	0.901	99.8	0.717	1.4	0.162	9.8	0.795	101.9	1.061	4.96

$V_{CE} = 3\text{ V}$, $I_C = 300\text{ mA}$, $Z_0 = 50\ \Omega$

Frequency (GHz)	S ₁₁		S ₂₁		S ₁₂		S ₂₂		K	MAG/MSG (dB)
	MAG.	ANG. (deg.)	MAG.	ANG. (deg.)	MAG.	ANG. (deg.)	MAG.	ANG. (deg.)		
0.1	0.754	-170.5	33.599	120.7	0.011	49.1	0.576	-127.2	0.713	34.99
0.2	0.816	-179.5	19.900	104.0	0.015	63.0	0.612	-156.1	0.901	31.33
0.3	0.817	177.4	13.409	94.6	0.020	63.5	0.612	-166.4	0.945	28.31
0.4	0.820	174.0	10.129	89.5	0.025	65.0	0.621	-173.6	0.987	26.14
0.5	0.820	171.5	8.019	85.5	0.029	65.6	0.623	-178.9	1.017	23.54
0.6	0.818	168.7	6.699	81.6	0.035	65.7	0.628	177.0	1.035	21.72
0.7	0.829	166.8	5.732	78.7	0.040	64.7	0.631	173.4	1.026	20.57
0.8	0.829	164.4	5.009	75.6	0.045	64.1	0.631	170.4	1.035	19.31
0.9	0.830	162.4	4.438	72.9	0.050	63.3	0.637	167.6	1.043	18.24
1.0	0.834	160.3	3.991	70.4	0.055	61.9	0.637	164.8	1.043	17.38
1.1	0.830	158.3	3.607	68.2	0.060	60.9	0.645	162.4	1.054	16.39
1.2	0.835	156.6	3.295	65.5	0.064	59.6	0.648	159.6	1.052	15.71
1.3	0.835	154.7	3.047	63.0	0.069	58.2	0.651	157.6	1.054	15.03
1.4	0.838	152.9	2.815	60.9	0.074	56.6	0.654	155.2	1.053	14.41
1.5	0.840	150.7	2.618	58.6	0.078	54.9	0.655	153.1	1.054	13.82
1.6	0.841	149.0	2.448	56.5	0.082	53.3	0.661	150.8	1.058	13.26
1.7	0.841	147.0	2.292	54.1	0.087	51.9	0.663	148.6	1.061	12.71
1.8	0.846	145.0	2.159	51.6	0.091	50.2	0.670	146.5	1.057	12.31
1.9	0.841	143.1	2.034	49.8	0.095	48.7	0.671	144.7	1.071	11.69
2.0	0.852	140.7	1.919	47.1	0.099	47.0	0.673	142.8	1.056	11.44
2.1	0.854	138.7	1.810	45.0	0.102	45.6	0.678	141.0	1.060	10.98
2.2	0.857	136.9	1.729	42.8	0.106	44.0	0.680	139.1	1.058	10.66
2.3	0.855	134.5	1.648	40.8	0.109	42.5	0.691	137.4	1.065	10.24
2.4	0.858	132.6	1.565	38.9	0.111	40.7	0.693	135.8	1.069	9.87
2.5	0.863	130.6	1.491	36.7	0.114	38.9	0.700	134.1	1.063	9.61
2.6	0.866	128.9	1.412	35.1	0.117	37.4	0.701	132.8	1.066	9.23
2.7	0.870	126.7	1.345	33.0	0.120	35.9	0.709	131.3	1.063	8.95
2.8	0.872	125.0	1.286	31.2	0.122	34.9	0.711	129.8	1.069	8.64
2.9	0.880	123.7	1.229	29.5	0.124	33.9	0.716	128.4	1.060	8.48
3.0	0.883	122.4	1.182	27.6	0.125	32.9	0.719	126.7	1.062	8.23
4.0	0.885	112.6	0.859	14.5	0.149	22.5	0.749	111.9	1.094	5.74
5.0	0.905	99.4	0.662	0.3	0.161	10.2	0.787	101.8	1.076	4.45

$V_{CE} = 3\text{ V}$, $I_C = 400\text{ mA}$, $Z_0 = 50\ \Omega$

Frequency (GHz)	S ₁₁		S ₂₁		S ₁₂		S ₂₂		K	MAG/MSG (dB)
	MAG.	ANG. (deg.)	MAG.	ANG. (deg.)	MAG.	ANG. (deg.)	MAG.	ANG. (deg.)		
0.1	0.806	-172.5	22.733	122.7	0.008	51.5	0.536	-143.9	1.023	33.34
0.2	0.852	-179.9	13.532	105.3	0.015	63.9	0.596	-165.2	0.994	29.55
0.3	0.858	176.5	9.140	95.0	0.019	63.2	0.602	-172.6	1.031	25.69
0.4	0.862	173.2	6.905	89.5	0.024	64.5	0.614	-178.2	1.055	23.08
0.5	0.860	170.6	5.470	85.4	0.029	65.6	0.617	177.4	1.090	20.87
0.6	0.857	168.1	4.566	81.3	0.035	65.6	0.623	173.9	1.106	19.21
0.7	0.865	165.8	3.911	78.2	0.040	65.3	0.626	170.8	1.098	18.02
0.8	0.867	163.7	3.417	75.0	0.045	64.1	0.625	168.0	1.098	16.91
0.9	0.866	161.5	3.029	72.0	0.049	63.3	0.631	165.5	1.112	15.83
1.0	0.868	159.7	2.726	69.6	0.054	62.0	0.631	162.9	1.111	14.97
1.1	0.865	157.7	2.467	67.1	0.059	60.9	0.640	160.6	1.129	14.04
1.2	0.868	155.8	2.256	64.4	0.064	59.6	0.641	158.2	1.124	13.34
1.3	0.869	154.0	2.089	61.8	0.069	58.1	0.646	156.2	1.121	12.72
1.4	0.872	152.2	1.932	59.5	0.073	56.6	0.647	153.8	1.119	12.11
1.5	0.872	149.9	1.801	57.3	0.078	55.0	0.648	151.9	1.126	11.51
1.6	0.871	148.0	1.688	54.9	0.082	53.3	0.655	149.6	1.129	10.95
1.7	0.874	146.1	1.583	52.5	0.086	52.0	0.656	147.6	1.126	10.48
1.8	0.877	144.1	1.492	50.0	0.091	50.2	0.664	145.5	1.120	10.06
1.9	0.872	142.3	1.411	48.1	0.094	48.8	0.664	143.7	1.140	9.47
2.0	0.881	140.0	1.334	45.3	0.098	47.2	0.668	141.8	1.120	9.23
2.1	0.882	137.8	1.259	42.9	0.102	45.8	0.671	140.0	1.124	8.77
2.2	0.886	135.8	1.205	40.7	0.105	44.2	0.672	138.4	1.115	8.53
2.3	0.881	133.7	1.152	38.7	0.108	42.5	0.683	136.4	1.135	8.04
2.4	0.884	131.7	1.095	36.8	0.111	40.9	0.685	135.0	1.135	7.71
2.5	0.888	129.7	1.046	34.6	0.114	39.1	0.695	133.4	1.127	7.46
2.6	0.889	128.0	0.994	32.8	0.117	37.5	0.692	132.2	1.134	7.08
2.7	0.892	126.0	0.948	30.7	0.120	36.0	0.700	130.5	1.130	6.80
2.8	0.894	124.3	0.908	28.9	0.121	35.1	0.702	129.2	1.137	6.51
2.9	0.905	123.1	0.868	27.0	0.123	34.2	0.706	127.9	1.110	6.48
3.0	0.904	121.6	0.838	25.2	0.125	33.3	0.709	126.4	1.120	6.17
4.0	0.902	111.8	0.624	11.8	0.149	22.8	0.740	111.8	1.160	3.81
5.0	0.917	98.8	0.496	-2.3	0.161	10.5	0.779	101.9	1.129	2.71

PACKAGE DIMENSIONS

FLAT-LEAD 4-PIN THIN-TYPE SUPER MINIMOLD (UNIT: mm)

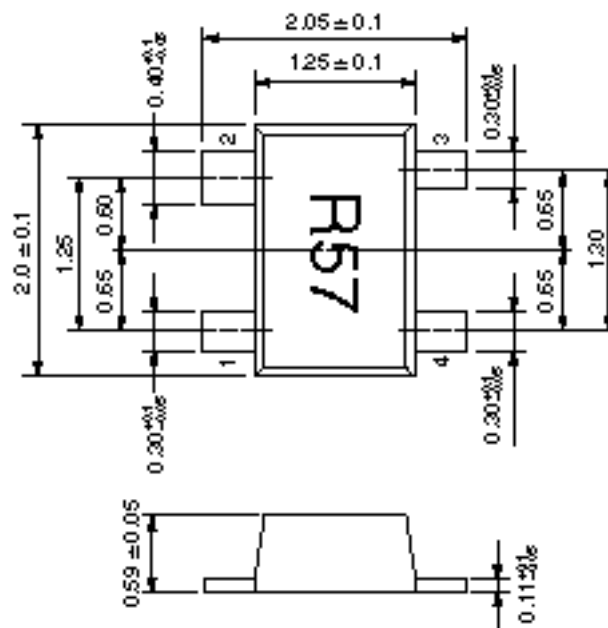
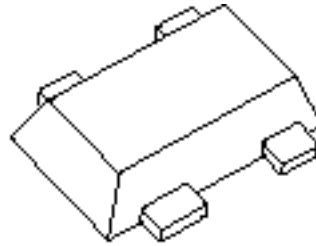

PIN CONNECTIONS

- 1. Emitter
- 2. Collector
- 3. Emitter
- 4. Base



Компания «ЭлектроПласт» предлагает заключение долгосрочных отношений при поставках импортных электронных компонентов на взаимовыгодных условиях!

Наши преимущества:

- Оперативные поставки широкого спектра электронных компонентов отечественного и импортного производства напрямую от производителей и с крупнейших мировых складов;
- Поставка более 17-ти миллионов наименований электронных компонентов;
- Поставка сложных, дефицитных, либо снятых с производства позиций;
- Оперативные сроки поставки под заказ (от 5 рабочих дней);
- Экспресс доставка в любую точку России;
- Техническая поддержка проекта, помощь в подборе аналогов, поставка прототипов;
- Система менеджмента качества сертифицирована по Международному стандарту ISO 9001;
- Лицензия ФСБ на осуществление работ с использованием сведений, составляющих государственную тайну;
- Поставка специализированных компонентов (Xilinx, Altera, Analog Devices, Intersil, Interpoint, Microsemi, Aeroflex, Peregrine, Syfer, Eurofarad, Texas Instrument, Miteq, Cobham, E2V, MA-COM, Hittite, Mini-Circuits, General Dynamics и др.);

Помимо этого, одним из направлений компании «ЭлектроПласт» является направление «Источники питания». Мы предлагаем Вам помощь Конструкторского отдела:

- Подбор оптимального решения, техническое обоснование при выборе компонента;
- Подбор аналогов;
- Консультации по применению компонента;
- Поставка образцов и прототипов;
- Техническая поддержка проекта;
- Защита от снятия компонента с производства.



Как с нами связаться

Телефон: 8 (812) 309 58 32 (многоканальный)

Факс: 8 (812) 320-02-42

Электронная почта: org@eplast1.ru

Адрес: 198099, г. Санкт-Петербург, ул. Калинина, дом 2, корпус 4, литера А.