

## Durable and Easy to Use

- Sealed bearings with IP65 oil resistance.
- Superior shaft loading performance. Radial: 80 N, Thrust: 50 N
- High shock resistance through application of metal slit.
- Optimum angle control possible in combination with PLC or cam positioner.

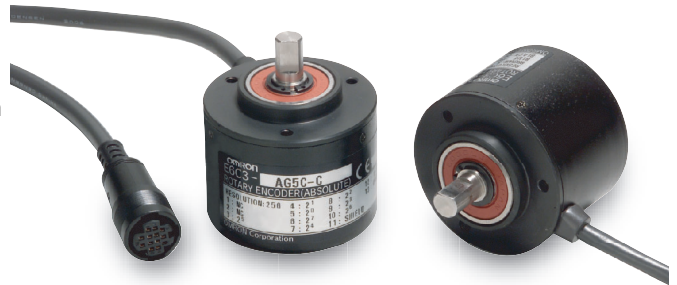

Be sure to read *Safety Precautions* on page 7.

## Ordering Information

### Encoders [Refer to *Dimensions* on page 8.]

Power supply voltage	Output configuration	Output code	Resolution (pulses/rotation)	Connection method	Model
12 to 24 VDC	Open-collector output (NPN)	Gray	256, 360, (720), *2	Pre-wired Connector Model (1 m)	<b>E6C3-AG5C-C (resolution) 1M</b> Example: E6C3-AG5C-C 256P/R 1M
			256, 360, 720, 1,024		<b>E6C3-AG5C (resolution) 1M</b> Example: E6C3-AG5C 256P/R 1M
		Binary	32, 40	Pre-wired Model (1 m) *1	<b>E6C3-AN5C (resolution) 1M</b> Example: E6C3-AN5C 32P/R 1M
	BCD	6, 8, 12	<b>E6C3-AB5C (resolution) 1M</b> Example: E6C3-AB5C 6P/R 1M		
	Open-collector output (PNP)	Gray	256, 360, 720, 1,024		<b>E6C3-AG5B (resolution) 1M</b> Example: E6C3-AG5B 256P/R 1M
		Binary	32, 40		<b>E6C3-AN5B (resolution) 1M</b> Example: E6C3-AN5B 32P/R 1M
BCD		6, 8, 12	<b>E6C3-AB5B (resolution) 1M</b> Example: E6C3-AB5B 6P/R 1M		
5 VDC	Voltage output	Binary	256		<b>E6C3-AN1E 256P/R 1M</b>
12 VDC				<b>E6C3-AN2E 256P/R 1M</b>	

\*1. Standard models are also available with 2-m cables. When ordering, specify the cable length at the end of the model number (example: E6C3-AG5C 360P/R 2M).

\*2. When connecting to the H8PS, use the E6C3-AG5C-C 256, 360, 720P/R. (Only a 2-m cable is available for the 720P/R Model.)  
For the 360/720 resolutions, 2-m cables are standard in-stock.

## Accessories (Order Separately)

[Dimensions: Refer to *Accessories* on page 8 for Extension Cable dimensions and *Accessories* for the dimensions of other accessories.]

Name	Model	Remarks
Couplings	<b>E69-C08B</b>	---
	<b>E69-C68B</b>	Different end diameter (6 to 8 mm)
Flanges	<b>E69-FCA03</b>	---
	<b>E69-FCA04</b>	E69-2 Servo Mounting Bracket provided.
Servo Mounting Bracket	<b>E69-2</b>	Provided with E69-FCA04 Flange.
Extension Cable	<b>E69-DF5</b>	5 m
	<b>E69-DF10</b>	10 m
	<b>E69-DF20</b>	20 m
		Applicable to the E6C3-AG5C-C. Models are also available with 15-m and 98-m cables.

Refer to *Accessories* for details.

## Ratings and Specifications

Item	Model	E6C3-AG5C-C	E6C3-AG5C	E6C3-AN5C	E6C3-AB5C	E6C3-AG5B	E6C3-AN5B	E6C3-AB5B	E6C3-AN1E	E6C3-AN2E
Power supply voltage	12 VDC -10% to 24 VDC +15%, ripple (p-p): 5% max.								5 VDC ±5%	12 VDC ±10%
Current consumption*1	70 mA max.									
Resolution*2 (pulses/rotation)	256, 360, 720	256, 360, 720, 1,024	32, 40	6, 8, 12	256, 360, 720, 1,024	32, 40	6, 8, 12	256		
Output code	Gray code		Binary	BCD	Gray code	Binary	BCD	Binary		
Output configuration	NPN open-collector output				PNP open-collector output				Voltage output	
Output capacity	Applied voltage: 30 VDC max. Sink current: 35 mA max. Residual voltage: 0.4 V max. (at sink current of 35 mA)				Source current: 35 mA max. Residual voltage: 0.4 V max. (at source current of 35 mA)				Output resistance: 2.4 kΩ	Output resistance: 8.2 kΩ
									Sink current: 35 mA max. Residual voltage: 0.4 V max. (at sink current of 35 mA)	
Rise and fall times of output	1 μs max. (Cable length: 2 m, Sink current: 35 mA)								Rise: 3 μs max., Fall: 1 μs max.	Rise: 10 μs max., Fall: 1 μs max.
Maximum response frequency*3	20 kHz								10 kHz	
Logic	Negative logic (high = 0, low = 1)				Positive logic (high = 1, low = 0)					
Direction of rotation*4	Output code increases for CW (as viewed from end of shaft).								Switched using rotation direction input.	
Strobe signal	None		Supported		None		Supported		None	
Positioning signal	None			Supported		None		Supported		None
Parity signal	None		Supported (even)	None			Supported (even)	None		
Starting torque	10 mN·m max. at room temperature, 30 mN·m max. at low temperature									
Moment of inertia	2.3 × 10 <sup>-6</sup> kg·m <sup>2</sup>									
Shaft loading	Radial		80 N							
	Thrust		50 N							
Maximum permissible speed	5,000 r/min									
Ambient temperature range	Operating: -10 to 70°C (with no icing), Storage: -25 to 85°C (with no icing)									
Ambient humidity range	Operating/Storage: 35% to 85% (with no condensation)									
Insulation resistance	20 MΩ min. (at 500 VDC) between current-carrying parts and case									
Dielectric strength	500 VAC, 50/60 Hz for 1 min between current-carrying parts and case									
Vibration resistance	Destruction: 10 to 500 Hz, 150 m/s <sup>2</sup> or 2-mm double amplitude for 11 min 3 times each in X, Y, and Z directions									
Shock resistance	Destruction: 1,000 m/s <sup>2</sup> 3 times each in X, Y, and Z directions									
Degree of protection	IEC 60529 IP65, in-house standards: oilproof									
Connection method	Connector Models *6		Pre-wired Models (Standard cable length: 1 m)							
Material	Case: Aluminum, Main unit: Aluminum, Shaft: SUS303									
Weight (packed state)	Approx. 300 g									
Accessories	Instruction manual									

\*1. An inrush current of approximately 6 A will flow for approximately 0.8 ms when the power is turned ON.

\*2. The code is as follows:

Output code	Resolution	Code No.
Binary	32	1 to 32
	40	1 to 40
	256	0 to 255
BCD	6	0 to 5
	8	0 to 7
	12	0 to 11
Gray	256	0 to 255
	360	76 to 435 (gray after 76)
	720	152 to 871 (gray after 152)
	1,024	0 to 1,023

\*3. The maximum electrical response speed is determined by the resolution and maximum response frequency as follows:

$$\text{Maximum electrical response speed (rpm)} = \frac{\text{Maximum response frequency}}{\text{Resolution}} \times 60$$

This means that the Rotary Encoder will not operate electrically if its speed exceeds the maximum electrical response speed.

\*4. For the E6C3-AN1E and E6C3-AN2E, the rotation direction input (wire color: pink) can be connected to high (Vcc) to increase the output code for CW rotation and connected to low (0 V) to decrease the output code for CW rotation.  
E6C3-AN1E: High = 1.5 to 5 V, Low = 0 to 0.8 V  
E6C3-AN2E: High = 2.2 to 12 V, Low = 0 to 1.2 V

Read the code 10 μs or more after the LSB (2<sup>0</sup>) of the code changes for the E6C3-AN1E or E6C3-AN2E.

\*5. The minimum address of the absolute code is output when cut face D on the shaft and the cable connection direction are as shown in the diagram at the right (output position range: ±15°).

\*6. Resolution of 360 or 720: Standard cable length: 2 m  
Resolution of 256: Standard cable length: 1 m

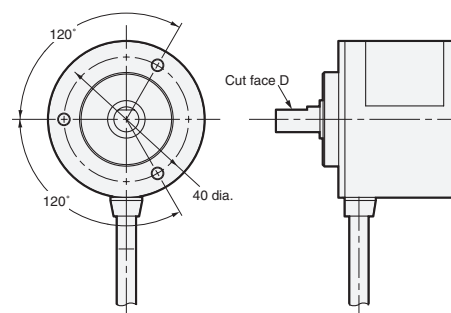

## I/O Circuit Diagrams

Model	E6C3-AG5C/-AG5C-C	E6C3-AG5B	E6C3-AN5C	E6C3-AN5B
<b>Output Circuits</b>	<p>Note: The circuit is the same for all bit outputs.</p>	<p>Note: The circuit is the same for all bit outputs.</p>	<p>Note: The circuit is the same for all bit outputs.</p>	<p>Note: The circuit is the same for all bit outputs.</p>
<b>Output mode</b>	<p>Direction of rotation: CW (as viewed from the end of the shaft)</p>	<p>Direction of rotation: CW (as viewed from the end of the shaft)</p> <p>Resolution/40</p> <p>Resolution of 32  A = 11.25°  B = 6°  C = 3°</p>		

## Connection Specifications

### Connector Models

Model	E6C3-AG5C-C		
	Output signal		
Pin No.	8-bit (256)	9-bit (360)	10-bit (720)
1	} Connected internally	Not connected	2 <sup>9</sup>
2		2 <sup>8</sup>	2 <sup>8</sup>
3	2 <sup>5</sup>	2 <sup>5</sup>	2 <sup>5</sup>
4	2 <sup>1</sup>	2 <sup>1</sup>	2 <sup>1</sup>
5	2 <sup>0</sup>	2 <sup>0</sup>	2 <sup>0</sup>
6	2 <sup>7</sup>	2 <sup>7</sup>	2 <sup>7</sup>
7	2 <sup>4</sup>	2 <sup>4</sup>	2 <sup>4</sup>
8	2 <sup>2</sup>	2 <sup>2</sup>	2 <sup>2</sup>
9	2 <sup>3</sup>	2 <sup>3</sup>	2 <sup>3</sup>
10	2 <sup>6</sup>	2 <sup>6</sup>	2 <sup>6</sup>
11	Shield (ground)		
12	12 to 24 VDC		
13	0 V (common)		

\* Connector: RP13A-12PD-13SC (Hirose Electric Co., Ltd.)  
Note: Normally connect GND to 0 V or to an external ground.

### Pre-wired Models

Model	E6C3-AG5C/E6C3-AG5B		
	Output signal		
Wire color	8-bit (256)	9-bit (360)	10-bit (720 or 1,024)
Brown	2 <sup>0</sup>	2 <sup>0</sup>	2 <sup>0</sup>
Orange	2 <sup>1</sup>	2 <sup>1</sup>	2 <sup>1</sup>
Yellow	2 <sup>2</sup>	2 <sup>2</sup>	2 <sup>2</sup>
Green	2 <sup>3</sup>	2 <sup>3</sup>	2 <sup>3</sup>
Blue	2 <sup>4</sup>	2 <sup>4</sup>	2 <sup>4</sup>
Purple	2 <sup>5</sup>	2 <sup>5</sup>	2 <sup>5</sup>
Gray	2 <sup>6</sup>	2 <sup>6</sup>	2 <sup>6</sup>
White	2 <sup>7</sup>	2 <sup>7</sup>	2 <sup>7</sup>
Pink	Not connected	2 <sup>8</sup>	2 <sup>8</sup>
Light blue	Not connected	Not connected	2 <sup>9</sup>
---	Shield (ground)		
Red	12 to 24 VDC		
Black	0 V (common)		

## I/O Circuit Diagrams

Model	E6C3-AB5C	E6C3-AB5B	E6C3-AN1E	E6C3-AN2E
Output circuits	<p>Note: The circuit is the same for all bit outputs.</p>	<p>Note: The circuit is the same for all bit outputs.</p>	<p>Note: The circuit is the same for all bit outputs.</p>	<p>Note: The circuit is the same for all bit outputs.</p>
	<p>Rotation Direction Input Circuit</p> <p>Note: If the input is connected to Vcc, the output will increase for CW rotation and if the input is connected to 0 V, the output code will decrease for CW rotation.</p>			
Output mode	<p>Direction of rotation: CW (as viewed from end of shaft) Resolution/12</p> <p>Resolution of 8 A = 45°, B = 22.5° C = 11.25° Resolution of 6 A = 60°, B = 30° C = 15°</p>		<p>Direction of rotation: CW (as viewed from end of shaft) if rotation direction input is high and CCW (as viewed from end of shaft) if rotation direction input is low.</p> <p><math>T = 360^\circ / 256 = 1.4^\circ</math></p>	

## Connection Specifications

### Pre-wired Models

Wire color	Model	E6C3-AN5C/-AN5B	E6C3-AB5C/-AB5B		E6C3-AN1E/-AN2E
	Output signal	Output signal	Output signal	Output signal	Output signal
	6-bit (32 or 40)	3-bit (6 or 8)	5-bit (12)	8-bit (256)	
Brown	2 <sup>0</sup>	2 <sup>0</sup>	2 <sup>0</sup>	2 <sup>0</sup>	2 <sup>0</sup>
Orange	2 <sup>1</sup>	2 <sup>1</sup>	2 <sup>1</sup>	2 <sup>1</sup>	2 <sup>1</sup>
Yellow	2 <sup>2</sup>	2 <sup>2</sup>	2 <sup>2</sup>	2 <sup>2</sup>	2 <sup>2</sup>
Green	2 <sup>3</sup>	Not connected	2 <sup>3</sup>	2 <sup>3</sup>	2 <sup>3</sup>
Blue	2 <sup>4</sup>	Not connected	2 <sup>0</sup> × 10	2 <sup>4</sup>	2 <sup>4</sup>
Purple	2 <sup>5</sup>	Not connected	Not connected	2 <sup>5</sup>	2 <sup>5</sup>
Gray	Parity	Positioning	Positioning	2 <sup>6</sup>	2 <sup>6</sup>
White	Strobe	Strobe	Strobe	2 <sup>7</sup>	2 <sup>7</sup>
Pink	Not connected	Not connected	Not connected	Rotation Direction Input	Rotation Direction Input
Light blue	Not connected	Not connected	Not connected	Not connected	Not connected
---	Shield (ground)				
Red	12 to 24 VDC			5 or 12 VDC	
Black	0 V (common)				

Note: Normally connect GND to 0 V or to an external ground.

## Connection Example

### H8PS Cam Positioner Connection Example



#### Ordering Information

Model
H8PS-8A
H8PS-8AP
H8PS-8AF
H8PS-8AFP
H8PS-16A
H8PS-16AP
H8PS-16AF
H8PS-16AFP
H8PS-32A
H8PS-32AP
H8PS-32AF
H8PS-32AFP

#### Specifications

<b>Rated voltage</b>	24 VDC
<b>Cam precision</b>	0.5° (for 720 resolution), 1° (for 256/360 resolution)
<b>No. of output points</b>	8-point output type: 8 cam outputs, 1 RUN output, 1 pulse output 16-point output type: 16 cam outputs, 1 RUN output, 1 pulse output 32-point output type: 32 cam outputs, 1 RUN output, 1 pulse output
<b>Encoder response</b>	RUN mode, test mode: 256/360 resolution ..... 1,600 r/min max. (1,200 r/min when advance compensation is set for four cams or more) 720 resolution ..... 800 r/min max. (600 r/min when advance compensation is set for four cams or more)
<b>Additional functions</b>	<ul style="list-style-type: none"> <li>• Origin compensation (zeroing)</li> <li>• Rotation direction switching</li> <li>• Angle display switching</li> <li>• Teaching</li> <li>• Pulse output</li> <li>• Angle/number of rotations display switching</li> <li>• Puncture *</li> <li>• Angle advance</li> <li>• Number of rotations alarm output</li> <li>• Setting with support software (order separately) *</li> </ul>

\* For 16-point and 32-point output types only

### Programmable Controller Connection Example Connections and System Configuration for E6C3-AG5C and the CQM1H (1,024 Resolution)

By combining the CQM1H-CPU51 and CQM1H-ABB21 with the E6C3-AG5C, output angle settings required to achieve 360° conversion, BCD conversion, and cam control can be easily made.

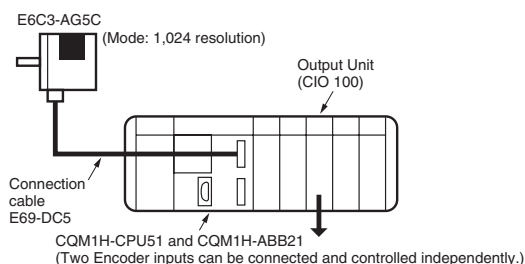

#### CQM1H-CPU51 Settings

Set port 1 to BCD mode and 10-bit resolution.

DM6643 0001

#### Output Timing



#### Ladder Program Example

The REGISTER COMPARISON TABLE (CTBL) instruction of the CQM1H-CPU51 is used to register a comparison table of output angle settings. Up to eight comparison can be registered.



#### DM Area Setting Example for Comparison Table

DM0000	0000	Lower limit 1	} Bit AR 0500
0001	0512	Upper limit 1	
0002	0000	Subroutine 1	} Bit AR 0501
0003	0256	Lower limit 2	
0004	0768	Upper limit 2	
0005	0000	Subroutine 2	} Bit AR 0502
0006	0128	Lower limit 3	
0007	0640	Upper limit 3	
0008	0000	Subroutine 3	} Not used in this example.
0009	0000	Lower limit 4	
0022	0000	Upper limit 8	
0023	0000		

Note: The upper and lower limits are set in increments of 1° in BCD mode and in increments of 5° in 360° mode. Subroutine numbers are set when interrupt processing is required.

#### CQM1H-CPU51 Memory Bits/Words

##### • Range Comparison Results

When the angle of the E6C3-AG5C falls in one of the comparison ranges, the corresponding bit in word AR 05 or AR 06 of the CQM1H-CPU51 turns ON.

The corresponding bit is OFF if there is no match.

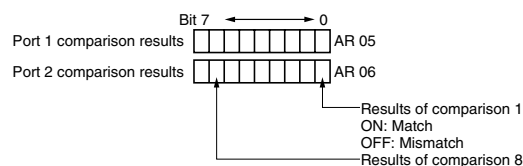

##### • Reading the PV

The grey code of the E6C3-AG5C is automatically converted to BCD or 360° and saved in words CIO 232 and CIO 234 in CQM1H-CPU51 memory.

The present value can also be used elsewhere in the ladder program.

Angle from port 1 \*\*\*\* CIO 232

Angle from port 2 \*\*\*\* CIO 234

Refer to the *CQM1H User's Manual (W363)* for details on the CQM1H-CPU51 Programmable Controller.

## Programmable Controller Connection Example

### Connection to the CPM1A (720 Resolution)



Wiring between the E6C3-AG5C and CPM1A

E6C3-AG5C out-put signal	CPM1A input signal
Brown ( $2^0$ )	00000
Orange ( $2^1$ )	00001
Yellow ( $2^2$ )	00002
Green ( $2^3$ )	00003
Blue ( $2^4$ )	00004
Purple ( $2^5$ )	00005
Gray ( $2^6$ )	00006
White ( $2^7$ )	00007
Pink ( $2^8$ )	00008
Light blue ( $2^9$ )	00009

Output Timing



### Ladder Programming Example



Converts gray code to binary (CIO 200). Sets the unused bits (10 to 15 bits) of CIO 200 to unused (always 0).



Converted to binary (CIO 200) and BCD (CIO 201).

(0) is set to carry flag.

Resolution is 720, so 152 is subtracted. No subtraction would be necessary for resolution of 256 or 1,024. If resolution was 360, 76 would be subtracted.

TABLE COMPARE Instruction If the Encoder value (CIO 202) is within a range in the conversion table set in DM 6200 to DM 6231, the corresponding bit in CIO 203 will turn ON.

Output

### DM Area Setting Example for Comparison Table

DM6200	0000	Lower limit 1	} Bit CIO 20300
6201	0540	Upper limit 1	
6202	0090	Lower limit 2	} Bit CIO 20301
6203	0360	Upper limit 2	
6204	0180	Lower limit 3	} Bit CIO 20302
6205	0659	Upper limit 3	
6206	0000	Lower limit 4	} Not used in this example.
6231	0000	Upper limit 16	

### CPM1A

For details, refer to the *SYSMAC C200HX/HG/HE/C200H/C200HS/CQM1/CPM1A/SRM1 Command Reference Manual* (SCCC-304).

## Safety Precautions

Refer to *Warranty and Limitations of Liability*.

### WARNING

This product is not designed or rated for ensuring safety of persons either directly or indirectly. Do not use it for such purposes.



### Precautions for Correct Use

Do not use the Encoder under ambient conditions that exceed the ratings.

#### ● Wiring

##### Connections

Cable Extension Characteristics

- Conditions will change according to frequency, noise, and other factors. As a guideline, use a cable length of 10 m\* or less.

\* Recommended Cable

Conductor cross section: 0.2 mm<sup>2</sup>

Spiral shield

Conductor resistance: 92 Ω/km max. (20°C)

Insulation resistance: 5 Ω/km min. (20°C)

- The output waveform startup time changes not only according to the length of the cable, but also according to the load resistance and the cable type.
- Extending the cable length not only changes the startup time, but also increases the output residual voltage.

#### ● Connection

Spurious pulses may be generated when power is turned ON and OFF. Wait at least 0.1 s after turning ON the power to the Encoder before using the connected device, and stop using the connected device at least 0.1 s before turning OFF the power to the Encoder. Also, turn ON the power to the load only after turning ON the power to the Encoder.

## Dimensions

Tolerance class IT16 applies to dimensions in this datasheet unless otherwise specified.

### Encoder

E6C3-A□5□

E6C3-AN□E

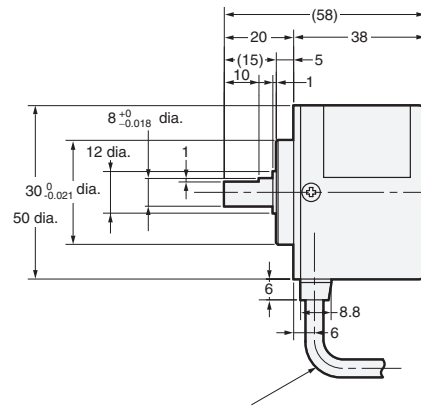

6-dia. oil-resistant PVC-insulated shielded cable with 12 conductors (Conductor cross section: 0.2 mm<sup>2</sup>, Insulator diameter: 1.1 mm), Standard length: 1 m

Note: The E69-C08B Coupling is sold separately.

### E6C3-AG5C-C

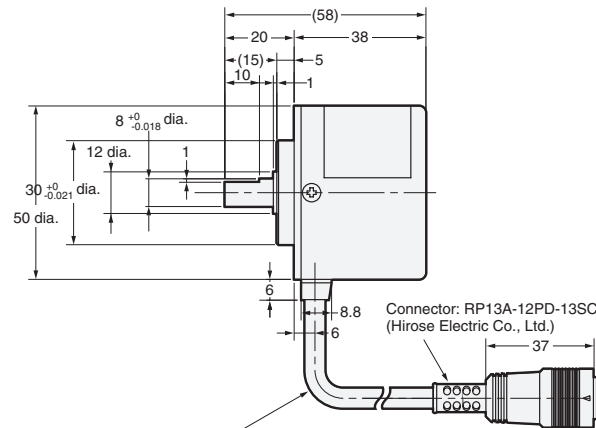

6-dia. oil-resistant PVC-insulated shielded cable with 12 conductors (Conductor cross section: 0.2 mm<sup>2</sup>, Insulator diameter: 1.1 mm), Standard length for resolution of 360 or 720: 2 m

Note: The E69-C08B Coupling is sold separately.

## Accessories (Order Separately)

### Extension Cable

E69-DF5

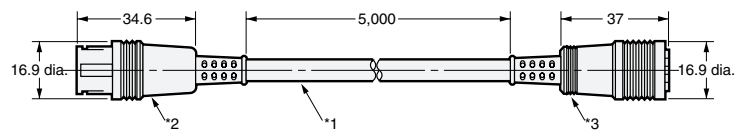

\*1. 6-dia. oil-resistant PVC-insulated shielded cable with 12 conductors (Conductor cross section: 0.2 mm<sup>2</sup>, Insulator diameter: 1.1 mm), Standard length: 5 m

\*2. Connects to connector on E6C3-AG5C-C.

\*3. Connects to H8PS Cam Positioner.

Note: 1. The E69-DF5 (5 m) is also available with the following cable lengths: 10 m, 15 m, 20 m, and 98 m.

2. Cable can be extended to 100 m when the H8PS Cam Positioner is connected.

### Couplings

E69-C08B

E69-C68B

Refer to *Accessories* for details.

### Flanges

E69-FCA03

E69-FCA04

### Servo Mounting Bracket

E69-2



## Read and Understand This Catalog

Please read and understand this catalog before purchasing the products. Please consult your OMRON representative if you have any questions or comments.

## Warranty and Limitations of Liability

### WARRANTY

OMRON's exclusive warranty is that the products are free from defects in materials and workmanship for a period of one year (or other period if specified) from date of sale by OMRON.

OMRON MAKES NO WARRANTY OR REPRESENTATION, EXPRESS OR IMPLIED, REGARDING NON-INFRINGEMENT, MERCHANTABILITY, OR FITNESS FOR PARTICULAR PURPOSE OF THE PRODUCTS. ANY BUYER OR USER ACKNOWLEDGES THAT THE BUYER OR USER ALONE HAS DETERMINED THAT THE PRODUCTS WILL SUITABLY MEET THE REQUIREMENTS OF THEIR INTENDED USE. OMRON DISCLAIMS ALL OTHER WARRANTIES, EXPRESS OR IMPLIED.

### LIMITATIONS OF LIABILITY

OMRON SHALL NOT BE RESPONSIBLE FOR SPECIAL, INDIRECT, OR CONSEQUENTIAL DAMAGES, LOSS OF PROFITS OR COMMERCIAL LOSS IN ANY WAY CONNECTED WITH THE PRODUCTS, WHETHER SUCH CLAIM IS BASED ON CONTRACT, WARRANTY, NEGLIGENCE, OR STRICT LIABILITY.

In no event shall the responsibility of OMRON for any act exceed the individual price of the product on which liability is asserted.

IN NO EVENT SHALL OMRON BE RESPONSIBLE FOR WARRANTY, REPAIR, OR OTHER CLAIMS REGARDING THE PRODUCTS UNLESS OMRON'S ANALYSIS CONFIRMS THAT THE PRODUCTS WERE PROPERLY HANDLED, STORED, INSTALLED, AND MAINTAINED AND NOT SUBJECT TO CONTAMINATION, ABUSE, MISUSE, OR INAPPROPRIATE MODIFICATION OR REPAIR.

## Application Considerations

### SUITABILITY FOR USE

OMRON shall not be responsible for conformity with any standards, codes, or regulations that apply to the combination of products in the customer's application or use of the products.

At the customer's request, OMRON will provide applicable third party certification documents identifying ratings and limitations of use that apply to the products. This information by itself is not sufficient for a complete determination of the suitability of the products in combination with the end product, machine, system, or other application or use.

The following are some examples of applications for which particular attention must be given. This is not intended to be an exhaustive list of all possible uses of the products, nor is it intended to imply that the uses listed may be suitable for the products:

- Outdoor use, uses involving potential chemical contamination or electrical interference, or conditions or uses not described in this catalog.
- Nuclear energy control systems, combustion systems, railroad systems, aviation systems, medical equipment, amusement machines, vehicles, safety equipment, and installations subject to separate industry or government regulations.
- Systems, machines, and equipment that could present a risk to life or property.

Please know and observe all prohibitions of use applicable to the products.

NEVER USE THE PRODUCTS FOR AN APPLICATION INVOLVING SERIOUS RISK TO LIFE OR PROPERTY WITHOUT ENSURING THAT THE SYSTEM AS A WHOLE HAS BEEN DESIGNED TO ADDRESS THE RISKS, AND THAT THE OMRON PRODUCTS ARE PROPERLY RATED AND INSTALLED FOR THE INTENDED USE WITHIN THE OVERALL EQUIPMENT OR SYSTEM.

### PROGRAMMABLE PRODUCTS

OMRON shall not be responsible for the user's programming of a programmable product, or any consequence thereof.

## Disclaimers

### CHANGE IN SPECIFICATIONS

Product specifications and accessories may be changed at any time based on improvements and other reasons.

It is our practice to change model numbers when published ratings or features are changed, or when significant construction changes are made. However, some specifications of the products may be changed without any notice. When in doubt, special model numbers may be assigned to fix or establish key specifications for your application on your request. Please consult with your OMRON representative at any time to confirm actual specifications of purchased products.

### DIMENSIONS AND WEIGHTS

Dimensions and weights are nominal and are not to be used for manufacturing purposes, even when tolerances are shown.

### PERFORMANCE DATA

Performance data given in this catalog is provided as a guide for the user in determining suitability and does not constitute a warranty. It may represent the result of OMRON's test conditions, and the users must correlate it to actual application requirements. Actual performance is subject to the OMRON Warranty and Limitations of Liability.

### ERRORS AND OMISSIONS

The information in this document has been carefully checked and is believed to be accurate; however, no responsibility is assumed for clerical, typographical, or proofreading errors, or omissions.

2008.11

In the interest of product improvement, specifications are subject to change without notice.

**OMRON Corporation**  
Industrial Automation Company

<http://www.ia.omron.com/>

(c)Copyright OMRON Corporation 2008 All Right Reserved.



Компания «ЭлектроПласт» предлагает заключение долгосрочных отношений при поставках импортных электронных компонентов на взаимовыгодных условиях!

Наши преимущества:

- Оперативные поставки широкого спектра электронных компонентов отечественного и импортного производства напрямую от производителей и с крупнейших мировых складов;
- Поставка более 17-ти миллионов наименований электронных компонентов;
- Поставка сложных, дефицитных, либо снятых с производства позиций;
- Оперативные сроки поставки под заказ (от 5 рабочих дней);
- Экспресс доставка в любую точку России;
- Техническая поддержка проекта, помощь в подборе аналогов, поставка прототипов;
- Система менеджмента качества сертифицирована по Международному стандарту ISO 9001;
- Лицензия ФСБ на осуществление работ с использованием сведений, составляющих государственную тайну;
- Поставка специализированных компонентов (Xilinx, Altera, Analog Devices, Intersil, Interpoint, Microsemi, Aeroflex, Peregrine, Syfer, Eurofarad, Texas Instrument, Miteq, Cobham, E2V, MA-COM, Hittite, Mini-Circuits, General Dynamics и др.);

Помимо этого, одним из направлений компании «ЭлектроПласт» является направление «Источники питания». Мы предлагаем Вам помощь Конструкторского отдела:

- Подбор оптимального решения, техническое обоснование при выборе компонента;
- Подбор аналогов;
- Консультации по применению компонента;
- Поставка образцов и прототипов;
- Техническая поддержка проекта;
- Защита от снятия компонента с производства.



#### Как с нами связаться

**Телефон:** 8 (812) 309 58 32 (многоканальный)

**Факс:** 8 (812) 320-02-42

**Электронная почта:** [org@eplast1.ru](mailto:org@eplast1.ru)

**Адрес:** 198099, г. Санкт-Петербург, ул. Калинина, дом 2, корпус 4, литера А.