

## CHIP NOISE FILTER NFZ2HBM□□□SN10L REFERENCE SPECIFICATION

### 1. Scope

This reference specification applies to NFZ2HBM\_SN10L, Chip Noise Filter.

### 2. Part Numbering

(ex) NF Z 2H BM 1R5 S N 1 0 L  
 Product ID Structure Dimension Characteristics Typical Impedance Performance Category Numbers of Circuit special speci- fication \*B: BULK Packaging L:Taping

\*B: Bulk packing also available

### 3. Rating

- Operating Temperature Range      - 55°C to + 125°C
- Storage Temperature Range        - 55°C to + 125°C

Customer Part Number	MURATA Part Number	Impedance at 1MHz		DC Resistance		Rated Current *1 (A)	Emission noise Restraint frequency (recommendation, MHz)
		(Ω)	Tolerance	(Ω)	Tolerance.		
	NFZ2HBM1R5SN10L	1.5	±30%	0.060	±25%	1.20	130-200
	NFZ2HBM2R9SN10L	2.9		0.085		1.10	110-150
	NFZ2HBM4R4SN10L	4.4		0.105		1.05	85-130
	NFZ2HBM6R1SN10L	6.1		0.125		1.00	75-110
	NFZ2HBM8R4SN10L	8.4		0.145		0.90	70-90
	NFZ2HBM110SN10L	11		0.160		0.80	60-80
	NFZ2HBM170SN10L	17		0.210		0.70	50-70
	NFZ2HBM240SN10L	24		0.250		0.65	45-65
	NFZ2HBM330SN10L	33		0.300		0.50	40-55
	NFZ2HBM600SN10L	60		0.300		0.40	30-50

\*1: When applied Rated current to the Products, self temperature rise shall be limited to 20°C max.  
 Typical value is actual performance.

### 4. Testing Conditions

《Unless otherwise specified》

《In case of doubt》

Temperature : Ordinary Temperature / 15°C to 35°C

Temperature : 20°C ± 2°C

Humidity : Ordinary Humidity / 25%(RH) to 85%(RH)

Humidity : 60%(RH) to 70%(RH)

Atmospheric Pressure : 86kPa to 106kPa

### 5. Appearance and Dimensions

0.6 ± 0.2

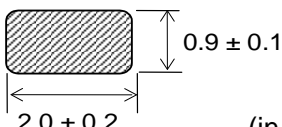
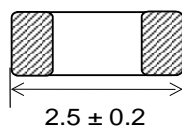
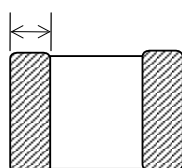

■ Unit Mass (Typical value)  
0.022g

(in mm)

## 6. Electrical Performance

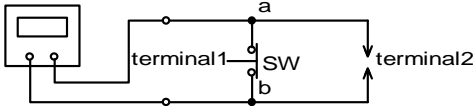
No.	Item	Specification	Test Method
6.1	Impedance	Impedance shall meet item 3.	Measuring Equipment: Agilent 4991A or equivalent (1mA) Measuring Frequency: 1MHz
6.2	DC Resistance	DC Resistance shall meet item 3.	Measuring Equipment: Digital multi meter Digital multi meter (TR6846 or equivalent)  <p>( DC resistance shall be measured after putting chip noise filter between the terminal 2 under the condition of opening between a and b. Every measurement the terminal 1 shall be shorted between a and b when changing noise filter.</p>

## 7. Mechanical Performance

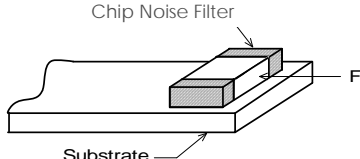
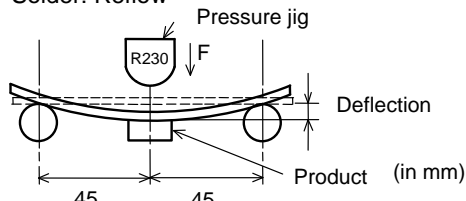
No.	Item	Specification	Test Method
7.1	Shear Test	Chip noise filter shall not be damaged after tested as follows.	Applied Direction  <p>Force: 10N Hold Duration: 5s±1s Applied Direction: Parallel to PCB</p>
7.2	Bending Test		Substrate: Glass-epoxy substrate (100mm × 40mm × 1.0mm) Solder: Reflow  <p>Speed of Applying Force: 0.5mm / s Deflection: 2mm Hold Duration: 30 s</p>
7.3	Vibration		Oscillation Frequency: 10Hz to 2000Hz to 10Hz for 20 min Total amplitude 3.0 mm or Acceleration amplitude 245m/s <sup>2</sup> whichever is smaller. Testing Time: A period of 4h in each of 3 mutually perpendicular directions.
7.4	Drop		It shall be dropped on concrete or steel board. Method : free fall Height : 1m Total of 10 cycles

No.	Item	Specification	Test Method
7.5	Solderability	The wetting area of the electrode shall be at least 90% covered with new solder coating.	Flux: Ethanol solution of rosin 25(wt)% (Immersed for 5s to 10s) Solder: Sn-3.0Ag-0.5Cu Pre-Heating: 150°C±10°C / 60s to 90s Solder Temperature: 240°C±5°C Immersion Time: 3s±1s
7.6	Resistance to Soldering Heat	Appearance: No damage Impedance Change: within ±30%	Flux: Ethanol solution of rosin 25(wt)% (Immersed for 5s to 10s) Solder: Sn-3.0Ag-0.5Cu Pre-Heating: 150°C±10°C / 60s to 90s Solder Temperature: 270°C±5°C Immersion Time: 10s±1s Then measured after exposure in the room condition for 24h±2h.

## 8. Environmental Performance

It shall be soldered on the substrate.

No.	Item	Specification	Test Method
8.1	Heat Resistance	Appearance: No damage Impedance Change: within ±30%	Temperature: 125°C±2°C Time: 1000h (+48h,-0h) Then measured after exposure in the room condition for 24h±2h.
8.2	Cold Resistance		Temperature: -55°C±2°C Time: 1000h (+48h,-0h) Then measured after exposure in the room condition for 24h±2h.
8.3	Humidity		Temperature: 40°C±2°C Humidity: 90%(RH) to 95%(RH) Time: 1000h (+48h,-0h) Then measured after exposure in the room condition for 24h±2h.
8.4	Temperature Cycle		1 cycle: 1 step: -55°C±2°C / 30 min±3 min 2 step: Ordinary temp. / 10 min to 15 min 3 step: 125°C±2°C / 30 min to 3 min 4 step: Ordinary temp. / 10 min to 15 min Total of 100cycles Then measured after exposure in the room condition for 24h±2h.

9. Specification of Packaging

9.1 Appearance and Dimensions of plastic tape (8mm-wide)



Dimension of the Cavity is measured at the bottom side.

9.2 Specification of Taping

- (1) Packing quantity (standard quantity)  
3,000 pcs / reel
- (2) Packing Method  
Products shall be packed in the each embossed cavity of plastic tape and sealed by cover tape.
- (3) Sprocket hole  
The sprocket holes are to the right as the tape is pulled toward the user.
- (4) Spliced point  
Plastic tape and Cover tape has no spliced point.
- (5) Missing components number  
Missing components number within 0.1% of the number per reel or 1 pc., whichever is greater, and are not continuous. The Specified quantity per reel is kept.

9.3 Pull Strength

Plastic tape	10N min.
Cover tape	5N min.

9.4 Peeling off force of cover tape

Speed of Peeling off	300mm / min
Peeling off force	Plastic tape: 0.1N to 0.7N (minimum value is typical)

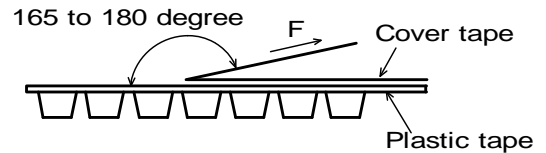

9.5 Dimensions of Leader-tape, Trailer and Reel

There shall be leader-tape (cover tape) and trailer-tape (empty tape) as follows.



**9.6 Marking for reel**

Customer part number, MURATA part number, Inspection number (\*1), RoHS marking (\*2), Quantity etc ...

- \*1) <Expression of Inspection No.> □□ 0000 xxx  
(1)           (2)           (3)
- (1) Factory Code  
 (2) Date      First digit       : Year / Last digit of year  
                   Second digit   : Month / Jan. to Sep. → 1 to 9, Oct. to Dec. → O, N, D  
                   Third, Fourth digit : Day  
 (3) Serial No.
- \*2) <Expression of RoHS marking >                    ROHS - Y (Δ)  
(1) (2)
- (1) RoHS regulation conformity parts.  
 (2) MURATA classification number

**9.7 Marking for Outside package (corrugated paper box)**

Customer name, Purchasing order number, Customer part number, MURATA part number, RoHS marking (\*2), Quantity, etc ...

**9.8 Specification of Outer Case**

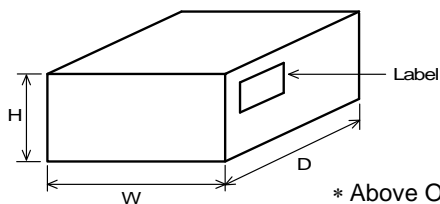

Outer Case Dimensions (mm)			Standard Reel Quantity in Outer Case (Reel)
W	D	H	
186	186	93	5

\* Above Outer Case size is typical. It depends on a quantity of an order

**10. ⚠ Caution**

**Limitation of Applications**

Please contact us before using our products for the applications listed below which require especially high reliability for the prevention of defects which might directly cause damage to the third party's life, body or property.

- |                                   |  |
|-----------------------------------|--|
| (1) Aircraft equipment            | (6) Transportation equipment (vehicles, trains, ships, etc.)   |
| (2) Aerospace equipment           | (7) Traffic signal equipment   |
| (3) Undersea equipment            | (8) Disaster prevention / crime prevention equipment   |
| (4) Power plant control equipment | (9) Data-processing equipment  |
| (5) Medical equipment             | (10) Applications of similar complexity and /or reliability requirements to the applications listed in the above |

**11. Notice**

This product is designed for solder mounting.  
 Please consult us in advance for applying other mounting method such as conductive adhesive.

**11.1 Land pattern designing**

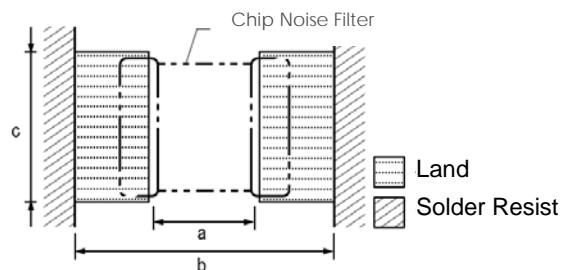

a	1.6
b	3.0
c	2.1

(in mm)

**11.2 Flux, Solder**

- Use rosin-based flux.  
Don't use highly acidic flux with halide content exceeding 0.2(wt) % (chlorine conversion value).  
Don't use water-soluble flux.
- Use Sn-3.0Ag-0.5Cu solder.
- Standard thickness of solder paste: 100 μm to 150 μm.

**11.3 Reflow soldering conditions**

- Pre-heating should be in such a way that the temperature difference between solder and product surface is limited to 150°C max. Cooling into solvent after soldering also should be in such a way that the temperature difference is limited to 100°C max.  
Insufficient pre-heating may cause cracks on the product, resulting in the deterioration of products quality.
- Standard soldering profile and the limit soldering profile is as follows.  
The excessive limit soldering conditions may cause leaching of the electrode and/or resulting in the deterioration of product quality.

Soldering profile

(1) Flow soldering profile

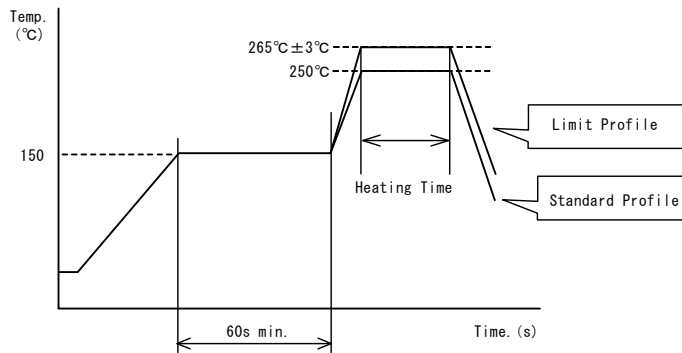

	Standard Profile	Limit Profile
Pre-heating	150°C, 60s min.	
Heating	250°C, 4s~6s	265°C±3°C, 5s
Cycle of flow	2 times	2 times

(2) Reflow soldering profile



	Standard Profile	Limit Profile
Pre-heating	150°C~180°C, 90s±30s	
Heating	above 220°C, 30s~60s	above 230°C, 60s max.
Peak temperature	245°C±3°C	260°C, 10s
Cycle of reflow	2 times	2 times

**11.4 Reworking with soldering iron**

The following conditions must be strictly followed when using a soldering iron.

Pre-heating	150°C, 1 min
Tip temperature	350°C max.
Soldering iron output	80W max.
Tip diameter	φ 3mm max.
Soldering time	3(+1, -0)s
Time	2 times

Note : Do not directly touch the products with the tip of the soldering iron in order to prevent the crack on the products due to the thermal shock.

**11.5 Solder Volume**

- Solder shall be used not to be exceeded the upper limits as shown below.
  - Accordingly increasing the solder volume, the mechanical stress to Chip is also increased.
- Exceeding solder volume may cause the failure of mechanical or electrical performance.

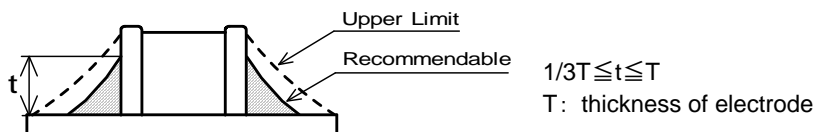

**11.6 Product's location**

The following shall be considered when designing and laying out P.C.B.'s.

- (1) P.C.B. shall be designed so that products are not subject to the mechanical stress due to warping the board.

[Products direction]

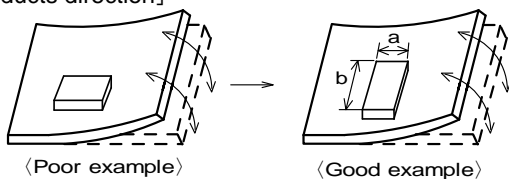

Products shall be located in the sideways direction (Length: a**) to the mechanical stress.**

- (2) Products location on P.C.B. separation

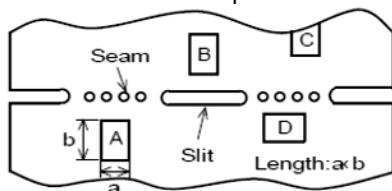

Products (A, B, C, D) shall be located carefully so that products are not subject to the mechanical stress due to warping the board. Because they may be subjected the mechanical stress in order of A · C · B · D.

**11.7 Cleaning Conditions**

Products shall be cleaned on the following conditions.

- (1) Cleaning temperature shall be limited to 60°C max. (40°C max for IPA.)
- (2) Ultrasonic cleaning shall comply with the following conditions with avoiding the resonance phenomenon at the mounted products and P.C.B.  
Power : 20 W / l max.    Frequency : 28kHz to 40kHz    Time : 5 min max.
- (3) Cleaner
  1. Alcohol type cleaner  
Isopropyl alcohol (IPA)
  2. Aqueous agent  
PINE ALPHA ST-100S
- (4) There shall be no residual flux and residual cleaner after cleaning. In the case of using aqueous agent, products shall be dried completely after rinse with de-ionized water in order to remove the cleaner.
- (5) Other cleaning    Please contact us.

### 11.8 Resin coating

The impedance value may change and/or it may affect on the product's performance due to high cure-stress of resin to be used for coating/molding products. So please pay your careful attention when you select resin.

In prior to use, please make the reliability evaluation with the product mounted in your application set.

### 11.9 Caution for use

There is possibility that the impedance value change due to magnetism. Don't use a magnet or a pair of tweezers with magnetism when chip noise filters are handled. (The tip of the tweezers should be molded with resin or pottery.)

### 11.10 Handling of a substrate

After mounting products on a substrate, do not apply any stress to the product caused by bending or twisting to the substrate when cropping the substrate, inserting and removing a connector from the substrate or tightening screw to the substrate.

Excessive mechanical stress may cause cracking in the product.

Bending

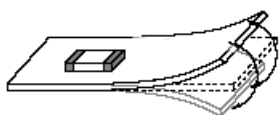

Twisting

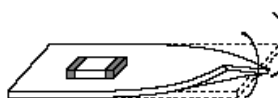

### 11.11 Storage and Handling Requirements

#### (1) Storage period

Use the products within 6 months after delivered.  
Solderability should be checked if this period is exceeded.

#### (2) Storage conditions

• Products should be stored in the warehouse on the following conditions.

Temperature : -10°C to 40°C

Humidity : 15% to 85% relative humidity No rapid change on temperature and humidity

Don't keep products in corrosive gases such as sulfur, chlorine gas or acid, or it may cause oxidization of electrode, resulting in poor solderability.

• Products should be stored on the palette for the prevention of the influence from humidity, dust and so on.

• Products should be stored in the warehouse without heat shock, vibration, direct sunlight and so on.

• Products should be stored under the airtight packaged condition.

#### (3) Handling Condition

Care should be taken when transporting or handling product to avoid excessive vibration or mechanical shock.

## 12. Note

(1) Please make sure that your product has been evaluated in view of your specifications with our product being mounted to your product.

(2) You are requested not to use our product deviating from the reference specifications.

(3) The contents of this reference specification are subject to change without advance notice.

Please approve our product specifications or transact the approval sheet for product specifications before ordering.





Компания «ЭлектроПласт» предлагает заключение долгосрочных отношений при поставках импортных электронных компонентов на взаимовыгодных условиях!

Наши преимущества:

- Оперативные поставки широкого спектра электронных компонентов отечественного и импортного производства напрямую от производителей и с крупнейших мировых складов;
- Поставка более 17-ти миллионов наименований электронных компонентов;
- Поставка сложных, дефицитных, либо снятых с производства позиций;
- Оперативные сроки поставки под заказ (от 5 рабочих дней);
- Экспресс доставка в любую точку России;
- Техническая поддержка проекта, помощь в подборе аналогов, поставка прототипов;
- Система менеджмента качества сертифицирована по Международному стандарту ISO 9001;
- Лицензия ФСБ на осуществление работ с использованием сведений, составляющих государственную тайну;
- Поставка специализированных компонентов (Xilinx, Altera, Analog Devices, Intersil, Interpoint, Microsemi, Aeroflex, Peregrine, Syfer, Eurofarad, Texas Instrument, Miteq, Cobham, E2V, MA-COM, Hittite, Mini-Circuits, General Dynamics и др.);

Помимо этого, одним из направлений компании «ЭлектроПласт» является направление «Источники питания». Мы предлагаем Вам помощь Конструкторского отдела:

- Подбор оптимального решения, техническое обоснование при выборе компонента;
- Подбор аналогов;
- Консультации по применению компонента;
- Поставка образцов и прототипов;
- Техническая поддержка проекта;
- Защита от снятия компонента с производства.



#### Как с нами связаться

**Телефон:** 8 (812) 309 58 32 (многоканальный)

**Факс:** 8 (812) 320-02-42

**Электронная почта:** [org@eplast1.ru](mailto:org@eplast1.ru)

**Адрес:** 198099, г. Санкт-Петербург, ул. Калинина, дом 2, корпус 4, литера А.