

## Ceramic Disc Capacitors Class 1 and 2, 500 V<sub>DC</sub>, General Purpose



Capacitors with 5 mm (0.20") and 7.5 mm (0.30") lead spacing

QUICK REFERENCE DATA		
DESCRIPTION	CLASS 1 (C0G (NP0), SL0)	CLASS 2 (Y5P, Z5U, Y5V, X5F)
Voltage (V <sub>DC</sub> )	500	
Min. Capacitance (pF)	10	100
Max. Capacitance (pF)	82	22 000
Mounting	Through hole	

### MARKING

Marking indicates capacitance value and tolerance in accordance with "EIA 198".

The capacitors meet the essential requirements of "EIA 198". Unless stated otherwise all electrical values apply at an ambient temperature of 25 °C ± 3 °C, at normal atmospheric conditions.

### OPERATING TEMPERATURE RANGE

Class 1, - 55 °C to + 125 °C

Class 2, - 55 °C to + 85 °C

### TEMPERATURE COEFFICIENTS

Class 1, C0G (NP0); SL0

Class 2, Y5P; Z5U; Y5V; X5F

### SECTIONAL SPECIFICATIONS

Class 1, IEC 60 384-8

Class 2, IEC 60 384-9

EIA 198

### CLIMATIC CATEGORY

Class 1, 55/125/21

Class 2, 10/85/21, 30/85/21 and 55/85/21

### FEATURES

- Low losses
- High stability
- High capacitance in small size
- Kinked (preferred) or straight leads
- Compliant to RoHS directive 2002/95/EC



**RoHS**  
COMPLIANT

### APPLICATIONS

- Bypassing
- Coupling
- Resonant circuit

### DESIGN

The capacitors consist of a ceramic disc both sides of which are silver-plated. Connection leads are made of tinned copper having a diameter of 0.6 mm.

The capacitors have inward kinked leads with a spacing of 5 mm (0.200") or 7.5 mm (0.300") and a lead length from 4 mm to 30 mm. Encapsulation is made of phenolic resin.

### CAPACITANCE RANGE

Class 1, at 1 MHz, 1.2 V<sub>RMS</sub>; 10 pF to 82 pF

Class 2, at 1 kHz, 1 ± 0.2 V<sub>RMS</sub>; 100 pF to 22 000 pF

1 kHz, 1 V<sub>RMS</sub> ± 0.2 V<sub>RMS</sub> for capacitance values higher than 1000 pF

### RATED DC VOLTAGE

500 V

### DIELECTRIC STRENGTH

250 % of rated voltage

### INSULATION RESISTANCE AT 500 V<sub>DC</sub>

≥ 10 000 MΩ

### TOLERANCE ON CAPACITANCE

± 5 %; ± 10 %; ± 20 %; + 80/- 20 %

### DISSIPATION FACTOR

Class 1, C ≤ 30 pF; ≤ 20 x (10/C + 0.7) x 10<sup>-4</sup> maximum

Class 1, C > 30 pF; ≤ 0.2 %

Class 2, ≤ 3.0 %



Ceramic Disc Capacitors  
Class 1 and 2, 500 V<sub>DC</sub>, General Purpose

Vishay BCcomponents

<b>ORDERING INFORMATION (PREFERRED TYPES), CLASS 1, 500 V<sub>DC</sub>, KINKED</b>					
C (pF)	TOL. (%)	D <sub>MAX.</sub> (mm)	LEAD SPACING (mm)	SH <sup>(1)</sup> (mm)	CLEAR TEXT CODE
					13 <sup>TH</sup> DIGIT: T = REEL; U = AMMO; 3 = BULK 16 <sup>TH</sup> DIGIT: R = RoHS COMPLIANT
<b>CLASS 1 NP0</b>					
10	± 5	5.0	5.0	4.0	D100J20C0GL6.J5.
12					D120J20C0GL6.J5.
15					D150J20C0GL6.J5.
18		D180J25C0GL6.J5.			
22		D220J25C0GL6.J5.			
27		D270J25C0GL6.J5.			
<b>CLASS 1 SL0</b>					
33	± 5	5.0	5.0	4.0	D330J20SL0L6.J5.
39					D390J20SL0L6.J5.
47					D470J20SL0L6.J5.
56		D560J20SL0L6.J5.			
68		D680J25SL0L6.J5.			
82		D820J25SL0L6.J5.			

**Notes**

<sup>(1)</sup> SH = seated height

- Maximum thickness 4.0 mm
- Lead style codes refer to inward kinked leads. Other styles available on request

<b>ORDERING INFORMATION (PREFERRED TYPES), CLASS 2, 500 V<sub>DC</sub>, KINKED</b>					
C (pF)	TOL. (%)	D <sub>MAX.</sub> (mm)	LEAD SPACING (mm)	SH <sup>(1)</sup> (mm)	CLEAR TEXT CODE
					13 <sup>TH</sup> DIGIT: T = REEL; U = AMMO; 3 = BULK 16 <sup>TH</sup> DIGIT: R = RoHS COMPLIANT
<b>CLASS 2 Y5P</b>					
100	± 10	5	5	4.0	D101K20Y5PL6.J5.
150					D151K20Y5PL6.J5.
220					D221K20Y5PL6.J5.
330					D331K20Y5PL6.J5.
470					D471K20Y5PL6.J5.
680					D681K25Y5PL6.J5.
1000		D102K25Y5PL6.J5.			
1500		D152K29Y5PL6.J5.			
2200		D222K33Y5PL6.J5.			
3300		D332K39Y5PL6.J5.			
4700		D472K43Y5PL6.J5.			
6800		D682K53Y5PL6.J7			
10 000		D103K69Y5PL6.J7.			
<b>CLASS 2 Y5V</b>					
1000	+ 80/- 20	5	5	4.0	D102Z20Y5VL6.J5.
1500					D152Z20Y5VL6.J5.
2200					D222Z25Y5VL6.J5.
3300		D322Z25Y5VL6.J5.			
4700		D472Z29Y5VL6.J5.			
6800		D682Z33Y5VL6.J5.			
10 000		D103Z39Y5VL6.J5.			
15 000		D153Z43Y5VL6.J5.			
22 000		D223Z53Y5VL6.J7.			
					7.5

ORDERING INFORMATION (PREFERRED TYPES), CLASS 2, 500 V <sub>DC</sub> , KINKED						
C (pF)	TOL. (%)	D <sub>MAX.</sub> (mm)	LEAD SPACING (mm)	SH <sup>(1)</sup> (mm)	CLEAR TEXT CODE	
					13 <sup>TH</sup> DIGIT: T = REEL; U = AMMO; 3 = BULK 16 <sup>TH</sup> DIGIT: R = RoHS COMPLIANT	
<b>CLASS 2 Z5U</b>						
1000	± 20	5.0	5.0	4.0	D102M20Z5UL6.J5.	
1500					D152M25Z5UL6.J5.	
2200					D222M25Z5UL6.J5.	
3300					7.5	D332M29Z5UL6.J5.
4700					8.5	D472M33Z5UL6.J5.
6800					10.0	D682M39Z5UL6.J5.
10 000		11.0	D103M43Z5UL6.J5.			
15 000		13.5	D153M53Z5UL6.J7.			
22 000		15.0	7.5		D223M59Z5UL6.J7.	
<b>CLASS 2 X5F</b>						
1 00	± 10	5.0	5.0	4.0	D101K20X5FL6.J5.R.	
2 20					D221K20X5FL6.J5.R.	
330					D331K20X5FL6.J5.R.	
470					6.5	D471K25X5FL6.J5.R.
680					D681K25X5FL6.J5.R.	
1000					7.5	D102K29X5FL6.J5.R.
2200		10.0	D222K39X5FL6.J5.R.			
3300		12.0	7.5		D332K47X5FL6.J7R.	
4700		13.5	4.8		D472K53X5FL6.J7R.	

**Note**

- (1) SH = seated height
- Maximum thickness 4.0 mm
- Lead style codes refer to inward kinked leads. Other styles available on request

PACKAGING				
D <sub>MAX.</sub> (mm)	SIZE CODE	PACKAGING QUANTITIES		
		BULK	REEL	AMMO
5.0 (0.20")	20	1000	2000	2000
6.5 (0.25")	25			
7.5 (0.29")	29			
8.5 (0.33")	33			
10.0 (0.39")	39			
11.0 (0.43")	43			
12.0 (0.47")	47	500	-	-
13.5 (0.53")	53			
15.0 (0.59")	59			
17.5 (0.69")	69			

**Note**

- The capacitors are supplied in bulk packaging (cardboard boxes), in tape on reel or in ammpack.

Ceramic Disc Capacitors  
 Class 1 and 2, 500 V<sub>DC</sub>, General Purpose

Vishay BCcomponents

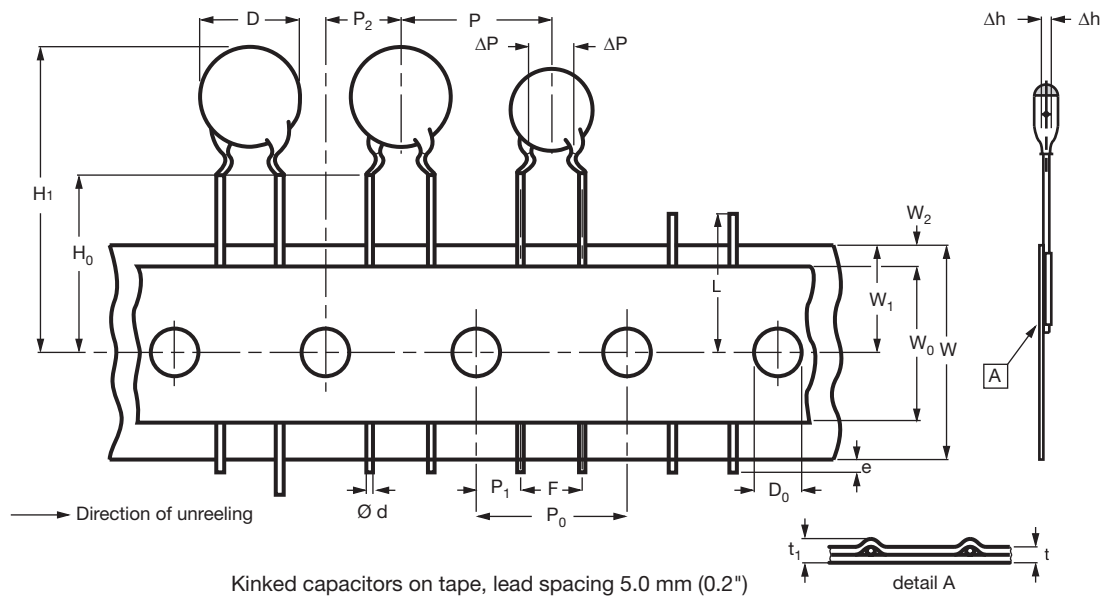

DIMENSIONS OF TAPE			
SYMBOL	PARAMETER	DIMENSIONS (mm)	
		NOMINAL	TOLERANCE
D	Body diameter	11.0 maximum	-
d	Lead diameter	0.6	± 0.05
P <sup>(1)</sup>	Pitch between capacitors	12.7	± 1.0
P <sub>0</sub>	Feed-hole pitch	12.7	± 0.3
ΔP	Plane deviation	1.0 maximum	-
P <sub>1</sub> <sup>(2)</sup>	Feed-hole center to lead center	3.85	± 0.7
P <sub>2</sub> <sup>(2)</sup>	Feed-hole center to component center	6.35	± 1.3
F	Lead spacing	5.0	0.6 - 0.4
Δh	Component alignment	0	± 1.0
W	Tape width	18.0	1.0 - 0.5
W <sub>0</sub>	Hold-down tape width	5.0 minimum	-
W <sub>1</sub>	Hole position	9.0	0.75 - 0.5
W <sub>2</sub>	Hold-down tape margin	3.0 maximum	-
H <sub>0</sub>	Height to seating plane	16.0	± 0.5
H <sub>1</sub>	Maximum component height	32.0	-
e	Lead end protrusion	1.0 maximum	-
L	Maximum length of snapped lead	11.0	-
D <sub>0</sub>	Feed-hole diameter	4.0	± 0.2
t	Total tape thickness	0.9 maximum	-
t <sub>1</sub>	Maximum thickness of tape and wires	1.5 maximum	-

**Notes**
<sup>(1)</sup> Cumulative pitch error: ± ≤ 1 mm/20 pitches

<sup>(2)</sup> Obliquity maximum 3°

# D Series

Vishay BCcomponents

Ceramic Disc Capacitors  
Class 1 and 2, 500 V<sub>DC</sub>, General Purpose



## REEL AND TAPE DATA in millimeters





## Disclaimer

ALL PRODUCT, PRODUCT SPECIFICATIONS AND DATA ARE SUBJECT TO CHANGE WITHOUT NOTICE TO IMPROVE RELIABILITY, FUNCTION OR DESIGN OR OTHERWISE.

Vishay Intertechnology, Inc., its affiliates, agents, and employees, and all persons acting on its or their behalf (collectively, "Vishay"), disclaim any and all liability for any errors, inaccuracies or incompleteness contained in any datasheet or in any other disclosure relating to any product.

Vishay makes no warranty, representation or guarantee regarding the suitability of the products for any particular purpose or the continuing production of any product. To the maximum extent permitted by applicable law, Vishay disclaims (i) any and all liability arising out of the application or use of any product, (ii) any and all liability, including without limitation special, consequential or incidental damages, and (iii) any and all implied warranties, including warranties of fitness for particular purpose, non-infringement and merchantability.

Statements regarding the suitability of products for certain types of applications are based on Vishay's knowledge of typical requirements that are often placed on Vishay products in generic applications. Such statements are not binding statements about the suitability of products for a particular application. It is the customer's responsibility to validate that a particular product with the properties described in the product specification is suitable for use in a particular application. Parameters provided in datasheets and/or specifications may vary in different applications and performance may vary over time. All operating parameters, including typical parameters, must be validated for each customer application by the customer's technical experts. Product specifications do not expand or otherwise modify Vishay's terms and conditions of purchase, including but not limited to the warranty expressed therein.

Except as expressly indicated in writing, Vishay products are not designed for use in medical, life-saving, or life-sustaining applications or for any other application in which the failure of the Vishay product could result in personal injury or death. Customers using or selling Vishay products not expressly indicated for use in such applications do so at their own risk. Please contact authorized Vishay personnel to obtain written terms and conditions regarding products designed for such applications.

No license, express or implied, by estoppel or otherwise, to any intellectual property rights is granted by this document or by any conduct of Vishay. Product names and markings noted herein may be trademarks of their respective owners.

## Material Category Policy

**Vishay Intertechnology, Inc. hereby certifies that all its products that are identified as RoHS-Compliant fulfill the definitions and restrictions defined under Directive 2011/65/EU of The European Parliament and of the Council of June 8, 2011 on the restriction of the use of certain hazardous substances in electrical and electronic equipment (EEE) - recast, unless otherwise specified as non-compliant.**

**Please note that some Vishay documentation may still make reference to RoHS Directive 2002/95/EC. We confirm that all the products identified as being compliant to Directive 2002/95/EC conform to Directive 2011/65/EU.**

**Vishay Intertechnology, Inc. hereby certifies that all its products that are identified as Halogen-Free follow Halogen-Free requirements as per JEDEC JS709A standards. Please note that some Vishay documentation may still make reference to the IEC 61249-2-21 definition. We confirm that all the products identified as being compliant to IEC 61249-2-21 conform to JEDEC JS709A standards.**



Компания «ЭлектроПласт» предлагает заключение долгосрочных отношений при поставках импортных электронных компонентов на взаимовыгодных условиях!

Наши преимущества:

- Оперативные поставки широкого спектра электронных компонентов отечественного и импортного производства напрямую от производителей и с крупнейших мировых складов;
- Поставка более 17-ти миллионов наименований электронных компонентов;
- Поставка сложных, дефицитных, либо снятых с производства позиций;
- Оперативные сроки поставки под заказ (от 5 рабочих дней);
- Экспресс доставка в любую точку России;
- Техническая поддержка проекта, помощь в подборе аналогов, поставка прототипов;
- Система менеджмента качества сертифицирована по Международному стандарту ISO 9001;
- Лицензия ФСБ на осуществление работ с использованием сведений, составляющих государственную тайну;
- Поставка специализированных компонентов (Xilinx, Altera, Analog Devices, Intersil, Interpoint, Microsemi, Aeroflex, Peregrine, Syfer, Eurofarad, Texas Instrument, Miteq, Cobham, E2V, MA-COM, Hittite, Mini-Circuits, General Dynamics и др.);

Помимо этого, одним из направлений компании «ЭлектроПласт» является направление «Источники питания». Мы предлагаем Вам помощь Конструкторского отдела:

- Подбор оптимального решения, техническое обоснование при выборе компонента;
- Подбор аналогов;
- Консультации по применению компонента;
- Поставка образцов и прототипов;
- Техническая поддержка проекта;
- Защита от снятия компонента с производства.



#### Как с нами связаться

**Телефон:** 8 (812) 309 58 32 (многоканальный)

**Факс:** 8 (812) 320-02-42

**Электронная почта:** [org@eplast1.ru](mailto:org@eplast1.ru)

**Адрес:** 198099, г. Санкт-Петербург, ул. Калинина, дом 2, корпус 4, литера А.