

# PR1 Relay Base for:

- Relays With SPDT or DPDT Contacts
- Solid-State Relays With the Same Structure

## Universal Modular System

The 15 mm (0.591 in.) wide PR1 relay base range is a modular system consisting of PR1-B... relay bases, compact electromechanical relays with SPDT or DPDT contacts, solid-state relays, and a comprehensive range of accessories. These include:

- Plug-in input/interference suppression modules
- Relay retaining bracket with labeling field and eject function
- Labels
- Continuous jumpers

Depending on the application, complete coupling relays can be created, which are optimized in terms of cost, function, and service life.

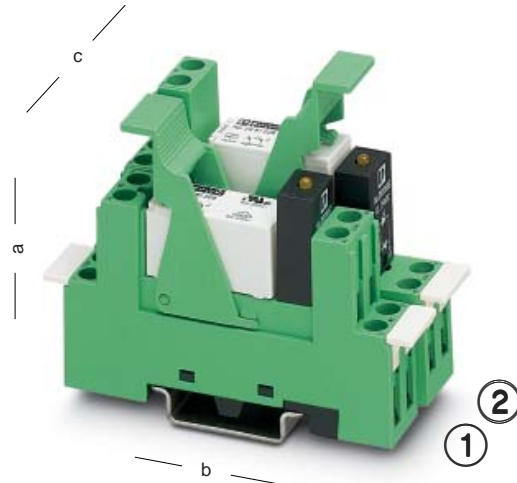

## Base Versions

The relay bases are available in two versions with screw connections<sup>3)</sup> - the flat 2/2 level PR1-BSC2 and the "logical" 1/3 level PR1-BSC3. The second version has coil and contact connections that are located opposite one another and thus meets the requirements of modern control cabinet concepts with clear isolation of control signals and load. Both bases can be extended in terms of functions through the use of keyed plug-in modules with various display and interference suppression elements.







## Cost-Effective Electromechanical Relays

Powerful and cost-effective REL-MR electromechanical miniature power relays are recommended for standard applications. They are available in the following versions:

- With one 16 A PDT contact
  - With two 8 A PDT contacts
  - In all popular AC and DC coil voltages
  - In power contact and gold contact versions
- Additional suitable standard and special relays (e.g., for lamp loads) are available on request<sup>4)</sup>.





## Alternative: Wear-Resistant Solid-State Relays

In critical applications, electromechanical relays reach their maximum service life relatively quickly. This is why, as an alternative, PR1-B... bases can be fitted with OPT wear-resistant solid-state relays with the same structure. These relays provide optimum service life for applications with a high switching frequency and/or for switching high DC loads.

	①	②
	PR1-BSC2...	PR1-BSC3...
Nominal voltage U <sup>1)</sup>	300 V AC	300 V AC
Nominal current I <sup>1)</sup>	12 A	12 A
Conductor cross section		
– Solid	2 x 2.5 mm <sup>2</sup>	2 x 2.5 mm <sup>2</sup>
– Flexible	2 x 2.5 mm <sup>2</sup>	2 x 2.5 mm <sup>2</sup>
American Wire Gauge	2 x 14 AWG	2 x 14 AWG
Connection type	 M 3	 M 3
Approvals <sup>2)</sup>		
Stripping length	8 mm (0.31 in.) 	8 mm (0.31 in.) 
Height (a) with retaining bracket:		
– EL1-P16	63 mm (2.480 in.)	66 mm (2.598 in.)
– EL1-P25	71 mm (2.795 in.)	79 mm (3.110 in.)
Depth (b)	75 mm (2.953 in.)	78.5 mm (3.091 in.)
Width (c)	15.5 mm (0.610 in.)	15.5 mm (0.610 in.)
Ambient temperature	-25°C...+85°C (-13°F...+185°F)	-25°C...+85°C (-13°F...+185°F)

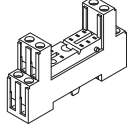
1) The maximum electrical data is relay dependent.  
 2) Details on request.  
 3) Spring-cage connections on request.  
 4) See INTERFACE catalog.

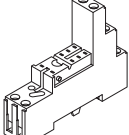
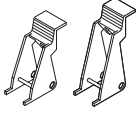
# PR1 Relay Base for Miniature Power Relays With SPDT or DPDT Contacts

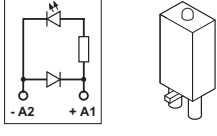
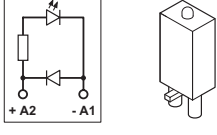
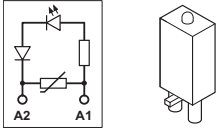
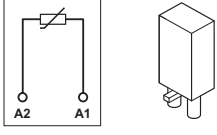
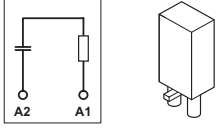
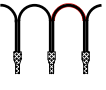
Description	Type	Order No.	Pcs. Pkt.
<p><b>PR1 relay base</b>, for miniature power relays or miniature switching relays with SPDT or DPDT contacts or solid-state relays with a similar structure, 2/2 level version, screw connections, optional connection of input/interference suppression module, for mounting on , safe isolation of I/Os, including MP1 markers, 10 pcs. per pack</p> 	PR1-BSC2/2x21	28 33 51 8	10
<p><b>PR1 relay base</b>, for miniature power relays or miniature switching relays with SPDT or DPDT contacts or solid-state relays with a similar structure, 1/3 level version, screw connections, optional connection of input/interference suppression module, for mounting on , safe isolation of I/Os, including MP1 markers, 10 pcs. per pack</p> 	PR1-BSC3/2x21	28 33 52 1	10
<p><b>Relay retaining bracket</b>, with eject function and integrated device marking area (7.5 x 15 mm [0.295 x 0.591 in.]), suitable for PR1 relay base:          – For 16 mm (0.630 in.) high miniature power relays and solid-state relays<sup>1)</sup>          – For 25 mm (0.984 in.) high miniature switching relays<sup>1)</sup> and solid-state relays<sup>1)</sup></p> 	EL1-P16 EL1-P25	28 33 54 7 28 33 55 0	10 10
<p><b>Device marker</b>, 6 x 15 mm (0.236 x 0.591 in.) marking area</p> 	MP1	28 33 63 1	10
<p><b>Plug-in module</b>, for mounting on PR1 and PR2, with free-wheeling diode and yellow LED, polarity: <b>A1 +, A2 –</b>          Input voltage:          – 12 - 24 V DC ±20%          – 48 - 60 V DC ±20%          – 110 V DC ±20%</p> 	LDP-12-24DC LDP-48-60DC LDP-110DC	28 33 65 7 28 33 66 0 28 33 67 3	10 10 10
<p><b>Plug-in module</b>, for mounting on PR1 and PR2, with free-wheeling diode and yellow LED, polarity: <b>A1 –, A2 +</b> (Japanese standard)          Input voltage:          – 12 -24 V DC ±20%          – 48 - 60 V DC ±20%          – 110 V DC ±20%</p> 	LDM-12-24DC LDM-48-60DC LDM-110DC	28 33 68 6 28 33 69 9 28 33 70 9	10 10 10
<p><b>Plug-in module</b>, for mounting on PR1 and PR2, with varistor and yellow LED, input voltage:          – 12 - 24 V AC/DC ±20%          – 48 - 60 V AC/DC ±20%          – 120 - 230 V AC/110 V DC ±20%</p> 	LV-12-24UC LV-48-60UC LV-120-230AC/110 DC	(30 V varistor) (75 V varistor) (275 V varistor)	28 33 71 2 28 33 72 5 28 33 73 8
<p><b>Plug-in module</b>, for mounting on PR1 and PR2, with varistor          Input voltage:          – 12 - 24 V AC/DC ±20%          – 48 - 60 V AC/DC ±20%          – 120 - 230 V AC/DC ±20%</p> 	V-12-24UC V-48-60UC V-120-230UC	(30 V varistor) (75 V varistor) (275 V varistor)	28 33 86 4 28 33 87 7 28 33 88 0
<p><b>Plug-in module</b>, for mounting on PR1 and PR2, with RC element          Input voltage:          – 12 - 24 V AC/DC ±20%          – 48 - 60 V AC/DC ±20%          – 120 - 230 V AC/DC ±20%</p> 	RC-12-24UC RC-48-60UC RC-120-230UC	(220 nF/100 Ω) (220 nF/220 Ω) (100 nF/470 Ω)	28 33 74 1 28 33 75 4 28 33 76 7
<p><b>Wire jumper</b>, 50-pos., can be separated, maximum jumpering distance of 60 mm (2.36 in.), 0.5 mm<sup>2</sup> (20 AWG), insulation:          – Blue          – Black          – Gray</p> 	DB 50-90 BU DB 50-90 BK DB 50-90 GY	28 21 18 0 28 20 91 6 28 20 92 9	1 1 1

<sup>1)</sup> See INTERFACE catalog

# REL-MR Plug-In Miniature Power Relays<sup>1)</sup> With SPDT Contact, Suitable for PR1 Relay Base

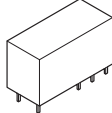
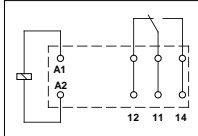
Description	
<b>Plug-in miniature power relays, with power contact, SPDT contact, suitable for PR1-B... base</b> Coil voltage: – 12 V DC – 24 V DC – 60 V DC – 110 V DC  – 24 V AC – 120 V AC – 230 V AC	
	
	
Pin assignment: view of the connections.	
<b>As above, but with solid gold coating, SPDT contact</b> Coil voltage: – 12 V DC – 24 V DC – 110 V DC  – 24 V AC – 120 V AC – 230 V AC	

Type	Order No.	Pcs. Pkt.
REL-MR- 12DC/21HC	29 61 30 9	10
REL-MR- 24DC/21HC	29 61 31 2	10
REL-MR- 60DC/21HC	29 61 32 5	10
REL-MR-110DC/21HC	29 61 33 8	10
REL-MR- 24AC/21HC	29 61 40 6	10
REL-MR-120AC/21HC	29 61 41 9	10
REL-MR-230AC/21HC	29 61 42 2	10
REL-MR- 12DC/21HC AU	29 61 53 2	10
REL-MR- 24DC/21HC AU	29 61 54 5	10
REL-MR-110DC/21HC AU	29 61 56 1	10
REL-MR- 24AC/21HC AU	29 61 50 3	10
REL-MR-120AC/21HC AU	29 61 51 6	10
REL-MR-230AC/21HC AU	29 61 52 9	10

## Technical Data

### Coil Side DC Coils

Nominal input voltage  $U_N$   
 Permissible range  
 Typical input current at  $U_N$   
 Typical response time at  $U_N$   
 Typical release time at  $U_N$   
 DC coil resistance at 20°C (68°F)

12 V DC	24 V DC	60 V DC	110 V DC
See diagram on page 5			
33 mA	17 mA	8.2 mA	4.1 mA
7 ms	7 ms	7 ms	7 ms
3 ms	3 ms	3 ms	3 ms
360 Ω ±10%	1440 Ω ±10%	7340 Ω -15+35%	26600 Ω -15+35%

### Coil Side AC Coils (50 Hz/60 Hz)

Nominal input voltage  $U_N$   
 Permissible range (with reference to  $U_N$ )  
 Typical input current at  $U_N$  (50 Hz/60 Hz)  
 Typical response time at  $U_N$  (depending on phase relation)  
 Typical release time at  $U_N$  (depending on phase relation)  
 DC coil resistance at 20°C (68°F)

24 V AC	120 V AC	230 V AC
See diagram on page 5		
32 mA/24 mA	7 mA/5 mA	3 mA/2.5 mA
3 - 12 ms	3 - 12 ms	3 - 12 ms
2 - 9 ms	2 - 9 ms	2 - 9 ms
350 Ω ±10%	8100 Ω ±15%	32500 Ω ±15%

### Contact Side

Contact type  
 Contact material  
 Maximum switching voltage  
 Minimum switching voltage  
 Limiting continuous current  
 Maximum inrush current  
 Minimum switching current  
 Maximum shutdown power (ohmic load) 250 V AC  
 Minimum switching power

REL-MR...21HC	REL-MR...21HCAU
Single contact, 1 Form C contact	Single contact, 1 Form C contact
AgNi	AgNi + 5 μ Au <sup>2)</sup>
250 V AC/DC	30 V AC/36 V DC(250 V AC/DC)
12 V	100 mV (12 V)
16 A	50 mA (16 A)
30 A (300 ms)	50 mA (30 A, 300 ms)
100 mA	1 mA (100 mA)
4000 VA	– (4000 VA)
For additional data, see diagram on page 5	
1.2 W	100 μW (1.2 W)

### General Data

Test voltage: Winding/contact  
 Ambient temperature  
 Nominal operating mode  
 Mechanical service life  
 Electrical service life  
 Standards/specifications

5 kV, 50 Hz, 1 minute  
 -40°C to +85°C (-40°F to +185°F)  
 100% ED  
 3 x 10<sup>7</sup> cycles  
 See diagram on page 5  
 IEC 60 255/DIN VDE 0435 (in relevant parts), DIN EN 50 178/  
 VDE 0160 (in relevant parts), EN 60 730/DIN VDE 0631,  
 IEC 60 664/IEC 60 664 A/DIN VDE 0110, degree of pollution 3,  
 Surge Voltage Category III  
 UL; CSA; VDE  
 Any/can be mounted without spacing

Approvals  
 Mounting position/mounting

<sup>1)</sup> Alternative: For REL/KSR miniature switching relay, OPT solid-state relay, see INTERFACE catalog.

<sup>2)</sup> If the specified maximum values are exceeded, the gold coating will be damaged. In subsequent operation, the maximum values given in brackets will apply. This can then result in reduced service life, similar to simple power contacts.

# REL-MR Plug-In Miniature Power Relays<sup>1)</sup> With DPDT Contacts, Suitable for PR1 Relay Base

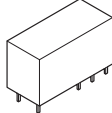
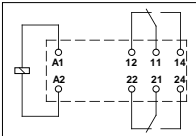
Description	
<b>Plug-in miniature power relays, with power contacts, DPDT contacts</b> Coil voltage: – 12 V DC – 24 V DC – 60 V DC – 110 V DC  – 24 V AC – 120 V AC – 230 V AC	
	
	
Pin assignment: view of the connections.	
<b>As above, but with solid gold coating, DPDT contacts</b> Coil voltage: – 12 V DC – 24 V DC – 60 V DC – 110 V DC  – 24 V AC – 120 V AC – 230 V AC	

Type	Order No.	Pcs. Pkt.
REL-MR- 12DC/21-21	29 61 25 7	10
REL-MR- 24DC/21-21	29 61 19 2	10
REL-MR- 60DC/21-21	29 61 27 3	10
REL-MR-110DC/21-21	29 61 20 2	10
REL-MR- 24AC/21-21	29 61 43 5	10
REL-MR-120AC/21-21	29 61 44 8	10
REL-MR-230AC/21-21	29 61 45 1	10
REL-MR- 12DC/21-21 AU	29 61 29 9	10
REL-MR- 24DC/21-21 AU	29 61 21 5	10
REL-MR- 60DC/21-21 AU	29 61 28 6	10
REL-MR-110DC/21-21 AU	29 61 22 8	10
REL-MR- 24AC/21-21 AU	29 61 46 4	10
REL-MR-120AC/21-21 AU	29 61 47 7	10
REL-MR-230AC/21-21 AU	29 61 48 0	10

### Technical Data

#### Coil Side DC Coils

Nominal input voltage  $U_N$   
 Permissible range  
 Typical input current at  $U_N$   
 Typical response time at  $U_N$   
 Typical release time at  $U_N$   
 DC coil resistance at 20°C (68°F)

12 V DC	24 V DC	60 V DC	110 V DC
See diagram on page 5			
33 mA	17 mA	8.2 mA	4.1 mA
7 ms	7 ms	7 ms	7 ms
3 ms	3 ms	3 ms	3 ms
360 Ω ±10%	1440 Ω ±10%	7340 Ω -15+35%	26600Ω -15+35%

#### Coil Side AC Coils (50 Hz/60 Hz)

Nominal input voltage  $U_N$   
 Permissible range (with reference to  $U_N$ )  
 Typical input current at  $U_N$  (50 Hz/60 Hz)  
 Typical response time at  $U_N$  (depending on phase relation)  
 Typical release time at  $U_N$  (depending on phase relation)  
 DC coil resistance at 20°C (68°F)

24 V AC	120 V AC	230 V AC
See diagram on page 5		
32 mA/24 mA	7 mA/5 mA	3 mA/2.5 mA
3 -12 ms	3 -12 ms	3 -12 ms
2 - 9 ms	2 - 9 ms	2 - 9 ms
350 Ω ±10%	8100 Ω ±15%	32500 Ω ±15%

#### Contact Side

Contact type  
 Contact material  
 Maximum switching voltage  
 Minimum switching voltage  
 Limiting continuous current  
 Maximum inrush current  
 Minimum switching current  
 Maximum shutdown power (ohmic load) 250 V AC  
 Minimum switching power

REL-MR...21-21	REL-MR...21-21AU
Single contact, 2 Form C contacts	Single contact, 2 Form C contacts
AgNi	AgNi + 5 μ Au <sup>2)</sup>
250 V AC/DC	30 V AC/36 V DC(250 V AC/DC)
5 V	100 mV (5 V)
8 A	50 mA (8 A)
15 A (300 ms)	50 mA (15 A, 300 ms)
10 mA	1 mA (10 mA)
2000 VA	– (2000 VA)
For additional data, see diagram on page 5	
50 mW	100 μW (50 mW)

#### General Data

Test voltage: Winding/contact  
 Contact/contact  
 Ambient temperature  
 Nominal operating mode  
 Mechanical service life  
 Electrical service life  
 Standards/specifications  
  
 Approvals  
 Mounting position/mounting

5 kV, 50 Hz, 1 minute  
 2.5 kV, 50 Hz, 1 minute  
 -40°C to +85°C (-40°F to +185°F)  
 100% ED  
 3 x 10<sup>7</sup> cycles  
 See diagram on page 5  
 IEC 60 255/DIN VDE 0435 (in relevant parts), DIN EN 50 178/  
 VDE 0160 (in relevant parts), EN 60 730/DIN VDE 0631,  
 IEC 60 664/IEC 60 664 A/DIN VDE 0110, degree of pollution 3,  
 Surge Voltage Category III  
 UL; CSA; VDE  
 Any/can be mounted without spacing

<sup>1)</sup> Alternative: For REL/KSR miniature switching relay, see INTERFACE catalog.

<sup>2)</sup> If the specified maximum values are exceeded, the gold coating will be damaged. In subsequent operation, the maximum values given in brackets will apply. This can then result in reduced service life, similar to simple power contacts.

# Diagrams for REL-MR... Miniature Power Relays

## REL-MR...21HC... (SPDT Contact)

### Operating voltage range

$$T_u = T_{coil}$$

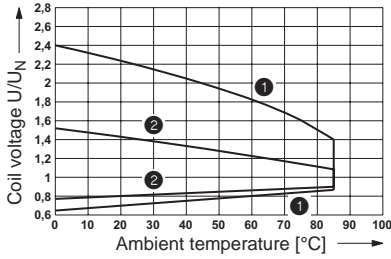

- 1 DC coils
- 2 AC coils

### Shutdown power

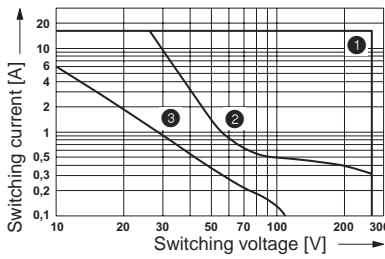

- 1 AC, ohmic load
- 2 DC, ohmic load
- 3 DC, L/R = 40 ms

### Electrical service life

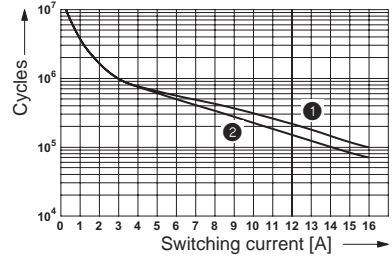

- 1 250 V AC, ohmic load (DC coils)
- 2 250 V AC, ohmic load (AC coils)

### Service life reduction factor

with varying  $\cos \varphi$

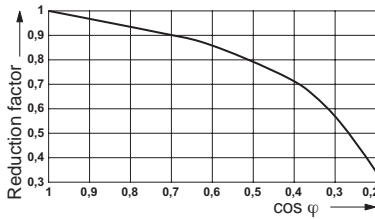

## REL-MR...21-21... (DPDT Contacts)

### Operating voltage range

$$T_u = T_{coil}$$

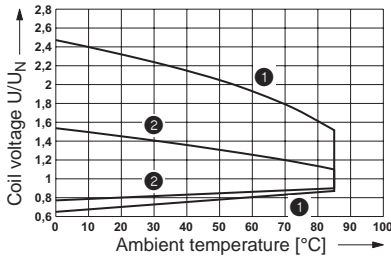

- 1 DC coils
- 2 AC coils

### Shutdown power

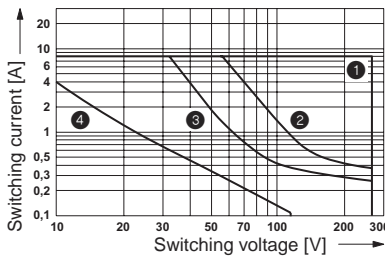

- 1 AC, ohmic load
- 2 DC, ohmic load, contacts in series
- 3 DC, ohmic load
- 4 DC, L/R = 40 ms

### Electrical service life

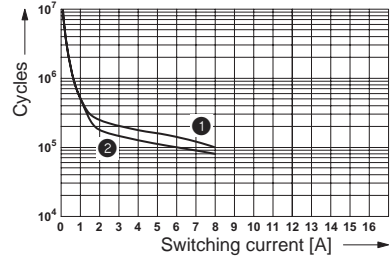

- 1 250 V AC, ohmic load (DC coils)
- 2 250 V AC, ohmic load (AC coils)

### Service life reduction factor

with varying  $\cos \varphi$

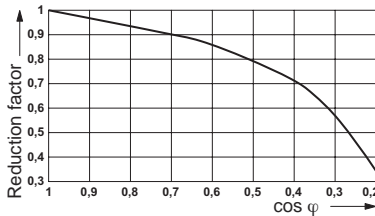



Компания «ЭлектроПласт» предлагает заключение долгосрочных отношений при поставках импортных электронных компонентов на взаимовыгодных условиях!

Наши преимущества:

- Оперативные поставки широкого спектра электронных компонентов отечественного и импортного производства напрямую от производителей и с крупнейших мировых складов;
- Поставка более 17-ти миллионов наименований электронных компонентов;
- Поставка сложных, дефицитных, либо снятых с производства позиций;
- Оперативные сроки поставки под заказ (от 5 рабочих дней);
- Экспресс доставка в любую точку России;
- Техническая поддержка проекта, помощь в подборе аналогов, поставка прототипов;
- Система менеджмента качества сертифицирована по Международному стандарту ISO 9001;
- Лицензия ФСБ на осуществление работ с использованием сведений, составляющих государственную тайну;
- Поставка специализированных компонентов (Xilinx, Altera, Analog Devices, Intersil, Interpoint, Microsemi, Aeroflex, Peregrine, Syfer, Eurofarad, Texas Instrument, Miteq, Cobham, E2V, MA-COM, Hittite, Mini-Circuits, General Dynamics и др.);

Помимо этого, одним из направлений компании «ЭлектроПласт» является направление «Источники питания». Мы предлагаем Вам помощь Конструкторского отдела:

- Подбор оптимального решения, техническое обоснование при выборе компонента;
- Подбор аналогов;
- Консультации по применению компонента;
- Поставка образцов и прототипов;
- Техническая поддержка проекта;
- Защита от снятия компонента с производства.



#### Как с нами связаться

**Телефон:** 8 (812) 309 58 32 (многоканальный)

**Факс:** 8 (812) 320-02-42

**Электронная почта:** [org@eplast1.ru](mailto:org@eplast1.ru)

**Адрес:** 198099, г. Санкт-Петербург, ул. Калинина, дом 2, корпус 4, литера А.