

RFI CAPACITORS FROM VISHAY

Safety Capacitors

Safety-Rated RFI Capacitors From Vishay

Typical Circuit

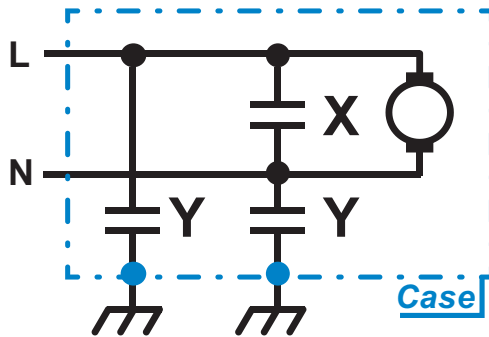

CLASS X

Differential Mode Filtering
Across the Line

Sub Class	Peak Impulse Voltage	Typical Application
X1	4.0 kV	High Pulse
X2	2.5 kV	General Purpose
X3	1.2 kV	General Purpose

Safety Capacitor Environment

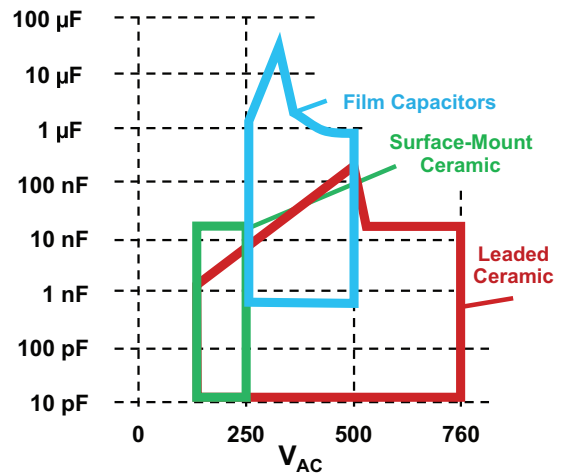

CLASS Y

Common Mode Filtering
Line to Ground

Sub Class	Peak Impulse Voltage	Typical Application
Y1	8.0 kV	High Pulse
Y2	5.0 kV	General Purpose
Y3	Not pulse rated	General Purpose
Y4	2.5 kV	General Purpose

BENEFITS FROM VISHAY









- All three capacitor technologies available from one source
- Wide product range
 - X2 from 10 pF up to 40 μF
- C0G (NP0) material available up to 1 nF nominal capacitance value in surface-mount capacitor
- Surface-mount product meets IEC 60384-14 min. 4 mm creepage at 1 nF in X1 / Y2 with COG (NP0)
- Y1 leaded ceramic up to 10 kV pulse strength guaranteed
- AEC-Q200 qualification available for film and leaded ceramic
 - AY2 leaded ceramic 3000 temp cycles from -55 °C to +125 °C
- F1772S withstands THB testing: 85 °C / 85 % RH / 240 V_{AC} / 1000 h
- VY1+C withstands THB testing: 85 °C / 85 % RH / 500 V_{AC} / 1000 h









A **WORLD OF**
SOLUTIONS™



RFI CAPACITORS FROM VISHAY

Safety Capacitors

RFI X and Y Film Capacitors								
Series	Rated AC Voltage (V)	Capacitance Min. (µF)	Capacitance Max. (µF)	Rated Temperature (°C)	Construction	Agency Approvals	Pitch	
 F1772SX2	310	0.01	2.2	110	Series	IEC / EN / UL / CSA	15 mm to 27.5 mm	
X2 and series impedance applications; 85 °C / 85 % RH, 240 V _{AC} for 1000 h								
 MKP339X2	310	0.001	4.7	110	Mono	IEC / EN / UL / CSA / CQC	7.5 mm to 27.5 mm	
AEC-Q200 Automotive Grade X2 class capacitor								
 F340X2	305	1	20	105	Mono	IEC / EN / UL / CSA	27.5 mm to 52.5 mm	
X2 class capacitor for high robustness under high humidity. THB grade III B-SOP Q3 2017								
 F340Y2	305	0.001	1	105	Mono	IEC / EN / UL / CSA / CQC	10 mm to 37.5 mm	
Y2 class capacitor for high robustness under high humidity. THB grade III B-SOP, Q3 2017								
 F340X1	480	0.22	8.2	105	Mono	IEC / EN / UL / CSA / CQC	22.5 mm to 52.5 mm	
X1 class capacitor for high robustness under high humidity. THB grade III B-SOP, Q3 2017								
 F339X1 480 V_{AC}	480	0.001	1	110	Series	IEC / EN / UL / CSA / CQC	10 mm to 27.5 mm	
X1 capacitor for high capacitance stability; 85 °C / 85 % RH, 400 V _{AC} for 500 h								
 MKP3386Y2	300	0.001	0.47	105	Series	IEC / EN / UL / CSA	7.5 mm to 27.5 mm	
AEC-Q200 Automotive Grade Y2 class capacitor								
 F1773X2	253	0.01	2.2	100	Series	IEC / EN / UL / CSA	-	
Axial X2 capacitor for low building height applications								

Leaded Ceramic Safety Capacitors						
Series	Voltage		Capacitance	Tolerance	Temperature Characteristics	
	Y Rating	X Rating				
 YY1 Series	500 V _{AC}	760 V _{AC}	10 pF to 4.7 nF	± 10 % / ± 20 %	U2J / Y5S / Y5U / Y5V	
AC-line rated ceramic disc capacitors; class X1: 760 V _{AC} ; class Y1: 500 V _{AC} ; this series includes mini sized YY1...Y5V						
 YY1 Compact Series	500 V _{AC}	760 V _{AC}	470 pF to 4.7 nF	± 20 %	Y5U	
Compact size and high pulse strength; AC-line rated ceramic disc capacitors; class X1: 760 V _{AC} ; class Y1: 500 V _{AC}						
 YY2 Series	300 V _{AC}	440 V _{AC}	10 pF to 10 nF	± 10 % / ± 20 %	U2J / Y5S / Y5U / Y5V	
AC-line rated ceramic disc capacitors; class X1: 440 V _{AC} ; class Y2: 300 V _{AC} ; this series includes mini sized YY2...Y5V						
 AY1 Series	500 V _{AC}	760 V _{AC}	470 pF to 4.7 nF	± 20 %	Y5U	
AC-line rated ceramic disc capacitors for automotive applications; class X1: 760 V _{AC} ; class Y1: 500 V _{AC}						
 AY2 Series	300 V _{AC}	440 V _{AC}	10 pF to 10 nF	± 10 % / ± 20 %	U2J / Y5S / Y5U	
AC-line rated ceramic disc capacitors for automotive applications; class X1: 440 V _{AC} ; class Y2: 300 V _{AC}						
 WKP Series	500 V _{AC}	760 V _{AC}	33 pF to 4.7 nF	± 10 % / ± 20 %	U2J / Y5S / Y5T / Y5U	
AC-line rated ceramic disc capacitors; class X1: 760 V _{AC} ; class Y1: 500 V _{AC}						
 WYO Series	250 V _{AC}	440 V _{AC}	1.0 nF to 12 nF	± 20 %	Y5U	
AC-line rated ceramic disc capacitors; class X1: 440 V _{AC} ; class Y2: 300 V _{AC}						
 440L Series	500 V _{AC}	760 V _{AC}	10 pF to 20 nF	± 10 % / ± 20 %	C0G / U2J / P3K / R3L	
AC-line rated ceramic disc capacitors; class X1: 760 V _{AC} ; class Y1: 500 V _{AC}						

Surface-Mount Ceramic Capacitors							
TCC	Rating	Rated AC Voltage	Body Size	Capacitance (pF)		Rated Temperature	Agency Approvals
				Min.	Max.		
C0G(NP0)	X1 / Y2	250	2008	10	220	-55 °C to +125 °C	IEC EN CAN/CSA cCSAus ANSI/UL
			2012	18	470		
	2220		47	1000			
	2008		10	390			
X7R	X1 / Y2	250	2012	18	470		
			2008	100	1000		
	2012		150	1200			
	2220		270	4700			
	X2		2008	100	2700		
			2012	150	5600		
			2220	270	12,000		

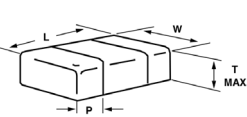
DIMENSIONS in inches (millimeters)							
	Body size	Length (L)	Width (W)	Maximum Thickness	Term. (P)		
					Min.	Max.	
	2008	0.200 ± 0.010 (5.08 ± 0.25)	0.080 ± 0.010 (2.03 ± 0.25)	0.086 (2.18)	0.010 (0.25)	0.030 (0.76)	
2012	0.200 ± 0.010 (5.08 ± 0.25)	0.126 ± 0.008 (3.20 ± 0.20)	0.086 (2.18)	0.010 (0.25)	0.030 (0.76)		
2220	0.220 ± 0.008 (5.59 ± 0.20)	0.200 ± 0.010 (5.08 ± 0.25)	0.086 (2.18)	0.010 (0.25)	0.030 (0.76)		



Компания «ЭлектроПласт» предлагает заключение долгосрочных отношений при поставках импортных электронных компонентов на взаимовыгодных условиях!

Наши преимущества:

- Оперативные поставки широкого спектра электронных компонентов отечественного и импортного производства напрямую от производителей и с крупнейших мировых складов;
- Поставка более 17-ти миллионов наименований электронных компонентов;
- Поставка сложных, дефицитных, либо снятых с производства позиций;
- Оперативные сроки поставки под заказ (от 5 рабочих дней);
- Экспресс доставка в любую точку России;
- Техническая поддержка проекта, помощь в подборе аналогов, поставка прототипов;
- Система менеджмента качества сертифицирована по Международному стандарту ISO 9001;
- Лицензия ФСБ на осуществление работ с использованием сведений, составляющих государственную тайну;
- Поставка специализированных компонентов (Xilinx, Altera, Analog Devices, Intersil, Interpoint, Microsemi, Aeroflex, Peregrine, Syfer, Eurofarad, Texas Instrument, Miteq, Cobham, E2V, MA-COM, Hittite, Mini-Circuits, General Dynamics и др.);

Помимо этого, одним из направлений компании «ЭлектроПласт» является направление «Источники питания». Мы предлагаем Вам помощь Конструкторского отдела:

- Подбор оптимального решения, техническое обоснование при выборе компонента;
- Подбор аналогов;
- Консультации по применению компонента;
- Поставка образцов и прототипов;
- Техническая поддержка проекта;
- Защита от снятия компонента с производства.



Как с нами связаться

Телефон: 8 (812) 309 58 32 (многоканальный)

Факс: 8 (812) 320-02-42

Электронная почта: org@eplast1.ru

Адрес: 198099, г. Санкт-Петербург, ул. Калинина, дом 2, корпус 4, литера А.