

μ -POWER OPERATIONAL AMPLIFIER

■ GENERAL DESCRIPTION

The NJM4250 is extremely versatile programmable monolithic operational amplifiers. A single external master bias current setting resistor programs the input bias current, input offset current, quiescent power consumption, slew rate, input noise, and the gain-bandwidth product. The device is a truly general purpose operational amplifier.

■ FEATURES

- Operating Voltage (±1V ~ ±18V)
- Low Operating Current (0.1mA max.)
- Programmable monolithic OP-Amp
- Very Low Power Consumption
- Package Outline DIP8, DMP8, SSOP8
- Bipolar Technology

■ PACKAGE OUTLINE

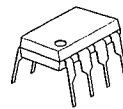

NJM4250D

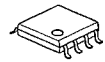

NJM4250M



NJM4250V

■ PIN CONFIGURATION

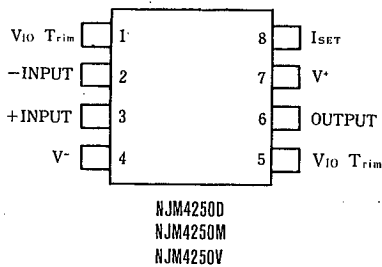

■ EQUIVALENT CIRCUIT (1/2 shown)

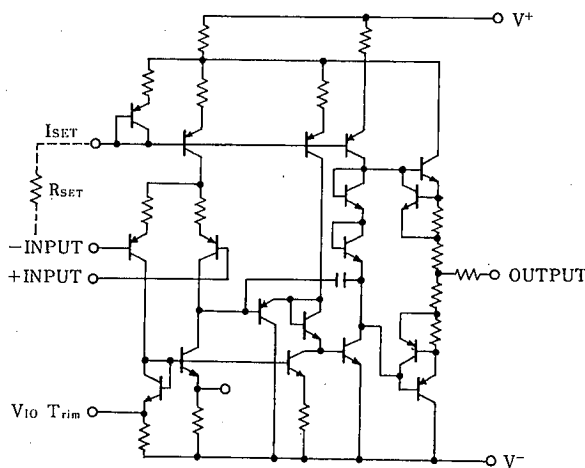

4

■ ABSOLUTE MAXIMUM RATINGS

(Ta=25°C)

PARAMETER	SYMBOL	RATINGS	UNIT
Supply Voltage	V ⁺ /V ⁻	±18	V
Differential Input Voltage	V _{ID}	±30	V
Input Voltage	V _{IC}	±15 (note)	V
Power Dissipation	P _D	(DIP8) 500	mW
		(DMP8) 300	mW
		(SSOP8) 250	mW
I _{SET} Current	I _{SET}	150	μA
Operating Temperature Range	T _{opr}	-20 ~ +75	°C
Storage Temperature Range	T _{stg}	-40 ~ +125	°C

(note) For supply voltage less than ±15V, the absolute maximum input voltage is equal to the supply voltage.

■ ELECTRICAL CHARACTERISTICS

(Ta=25°C, V⁺/V⁻=±15V)

PARAMETER	SYMBOL	TEST CONDITION	I _{SET} =1 μA		I _{SET} =10 μA		UNIT
			MIN.	MAX.	MIN.	MAX.	
Input Offset Voltage 1	V _{IO 1}	R _S ≤ 100kΩ	—	5	—	6	mV
Input Offset Voltage 2	V _{IO 2}	V ⁺ /V ⁻ = ±1.5V, R _S ≤ 100kΩ	—	5	—	6	mV
Input Offset Current	I _{IO}		—	6	—	20	nA
Input Bias Current 1	I _{B 1}		—	10	—	75	nA
Input Bias Current 2	I _{B 2}	V ⁺ /V ⁻ = ±1.5V	—	10	—	75	nA
Large Signal Voltage Gain 1	A _{v 1}	V _o = ±10V, R _L ≥ 100kΩ	96	—	—	—	dB
Large Signal Voltage Gain 2	A _{v 2}	V _o = ±10V, R _L ≥ 10kΩ	—	—	96	—	dB
Operating Current 1	I _{CC 1}		—	11	—	100	μA
Operating Current 2	I _{CC 2}	V ⁺ /V ⁻ = ±1.5V	—	8	—	90	μA
Input Common Mode Voltage Range 1	V _{ICM 1}		±13.5	—	±13.5	—	V
Input Common Mode Voltage Range 2	V _{ICM 2}	V ⁺ /V ⁻ = ±1.5V	±0.6	—	±0.6	—	V
Maximum Output Voltage Swing 1	V _{OM 1}	R _L ≥ 100kΩ	±12	—	—	—	V
Maximum Output Voltage Swing 2	V _{OM 2}	V ⁺ /V ⁻ = ±1.5V, R _L ≥ 100kΩ	±0.6	—	—	—	V
Maximum Output Voltage Swing 3	V _{OM 3}	R _L ≥ 10kΩ	—	—	±12	—	V
Maximum Output Voltage Swing 4	V _{OM 4}	V ⁺ /V ⁻ = ±1.5V, R _L ≥ 10kΩ	—	—	±0.6	—	V
Common Mode Rejection Ratio	CMR	R _S ≤ 10kΩ	70	—	70	—	dB
Supply Voltage Rejection Ratio	SVR	R _S ≤ 10kΩ	74	—	74	—	dB

■ TYPICAL APPLICATION (I_{SET}, V_{IO} Adjustment)

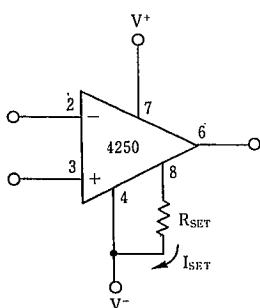

$$I_{SET} = \frac{V^+ + |V^-| - 0.5}{R_{SET}}$$

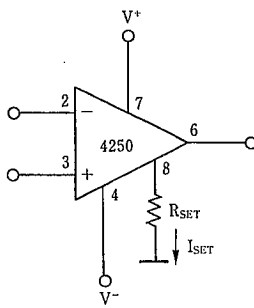

$$I_{SET} = \frac{V^+ - 0.5}{R_{SET}}$$

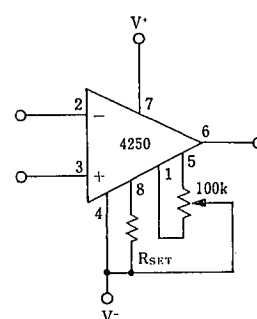

Offset Adjustment

TYPICAL CHARACTERISTICS

Input Bias Current vs. Set Current
($T_a = 25^\circ\text{C}$)

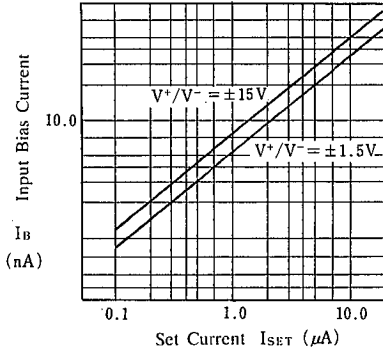

Input Bias Current vs. Temperature

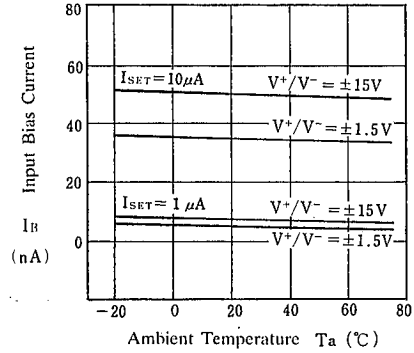

Input Offset Current vs. Ambient Temperature

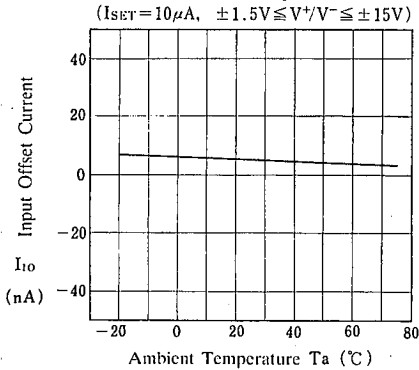

Input Offset Voltage vs. Set Current

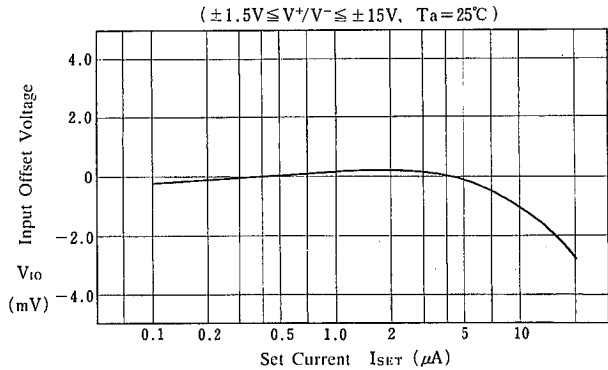

Input Offset Voltage vs. Ambient Temperature

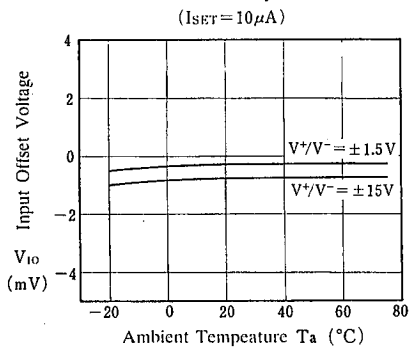

Maximum Output Voltage Swing vs. Output Current

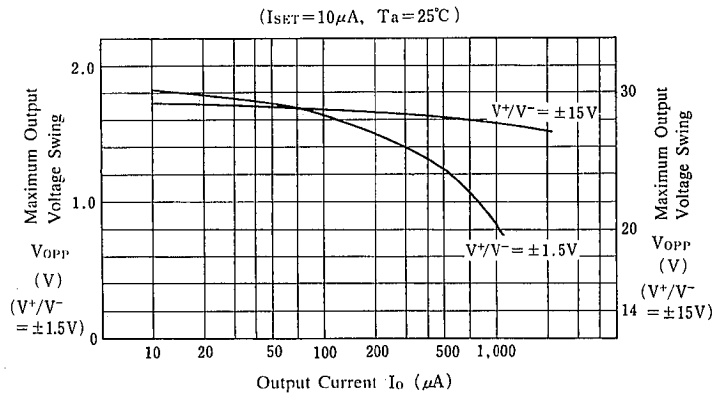

■ TYPICAL CHARACTERISTICS

Maximum Output Voltage Swing
vs.
Operating Voltage
($1\mu A \leq I_{SET} \leq 10\mu A$, $R_L = 10k\Omega$, $T_a = 25^\circ C$)

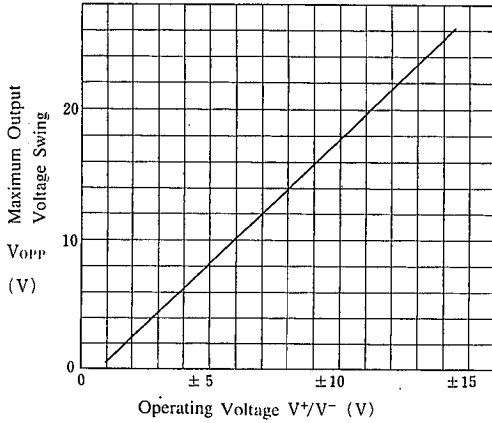

Operating Current
vs.
Set Current
($T_a = 25^\circ C$)

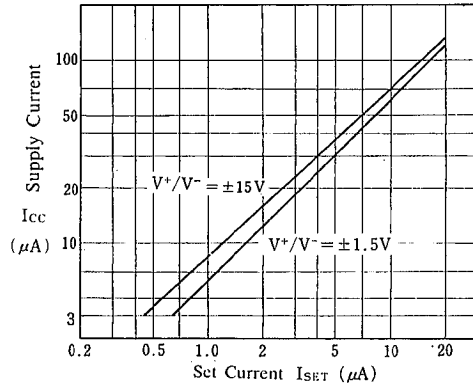

Operating Current
vs.
Ambient Temperature

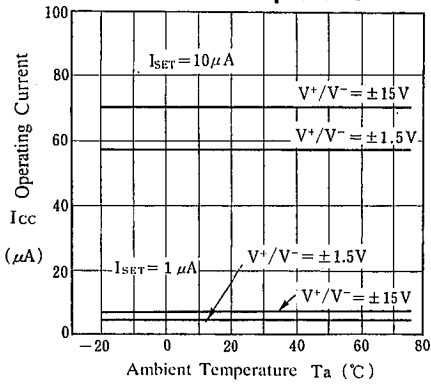

Open Loop Voltage Gain
vs.
Set Current
($R_L = 10k\Omega$, $T_a = 25^\circ C$)

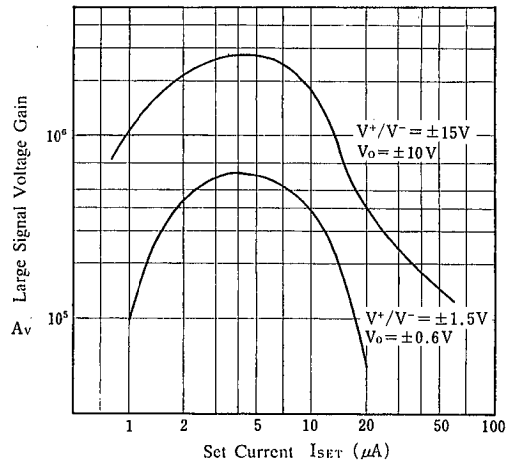

4

■ TYPICAL CHARACTERISTICS

Gain Bandwidth Product vs. Set Current
($T_a = 25^\circ\text{C}$)

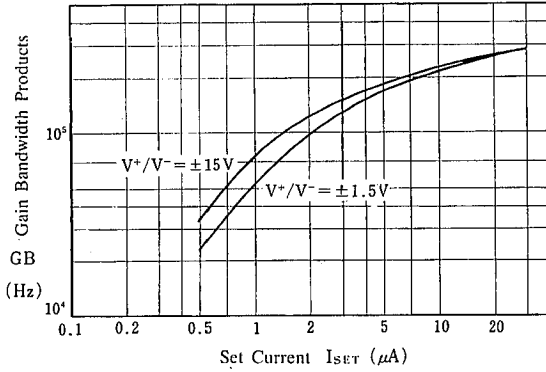

Slew Rate vs. Set Current
($R_L = 10\text{k}\Omega$, $T_a = 25^\circ\text{C}$)

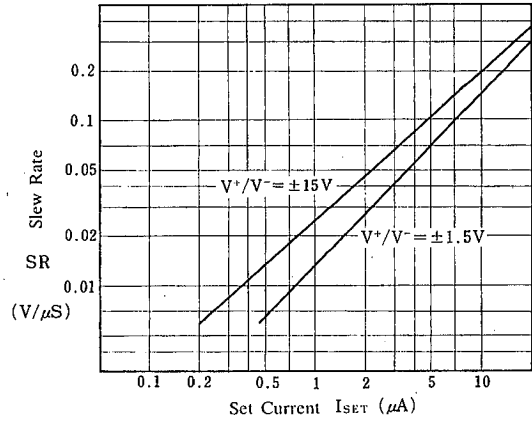

Phase Margin vs. Set Current

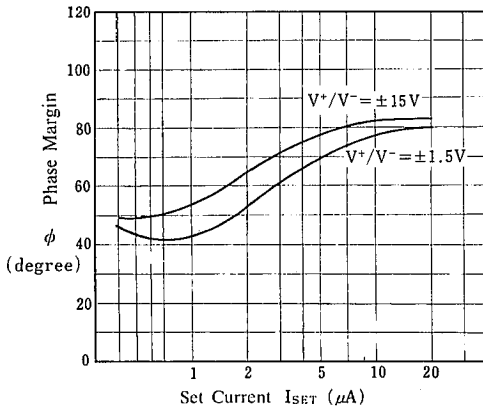

■ TYPICAL APPLICATIONS

500nW, 10times Inverting Amplifier

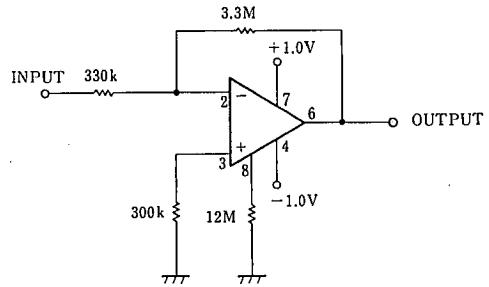

MEMO

[CAUTION]

The specifications on this databook are only given for information, without any guarantee as regards either mistakes or omissions. The application circuits in this databook are described only to show representative usages of the product and not intended for the guarantee or permission of any right including the industrial rights.



Компания «ЭлектроПласт» предлагает заключение долгосрочных отношений при поставках импортных электронных компонентов на взаимовыгодных условиях!

Наши преимущества:

- Оперативные поставки широкого спектра электронных компонентов отечественного и импортного производства напрямую от производителей и с крупнейших мировых складов;
- Поставка более 17-ти миллионов наименований электронных компонентов;
- Поставка сложных, дефицитных, либо снятых с производства позиций;
- Оперативные сроки поставки под заказ (от 5 рабочих дней);
- Экспресс доставка в любую точку России;
- Техническая поддержка проекта, помощь в подборе аналогов, поставка прототипов;
- Система менеджмента качества сертифицирована по Международному стандарту ISO 9001;
- Лицензия ФСБ на осуществление работ с использованием сведений, составляющих государственную тайну;
- Поставка специализированных компонентов (Xilinx, Altera, Analog Devices, Intersil, Interpoint, Microsemi, Aeroflex, Peregrine, Syfer, Eurofarad, Texas Instrument, Miteq, Cobham, E2V, MA-COM, Hittite, Mini-Circuits, General Dynamics и др.);

Помимо этого, одним из направлений компании «ЭлектроПласт» является направление «Источники питания». Мы предлагаем Вам помощь Конструкторского отдела:

- Подбор оптимального решения, техническое обоснование при выборе компонента;
- Подбор аналогов;
- Консультации по применению компонента;
- Поставка образцов и прототипов;
- Техническая поддержка проекта;
- Защита от снятия компонента с производства.



Как с нами связаться

Телефон: 8 (812) 309 58 32 (многоканальный)

Факс: 8 (812) 320-02-42

Электронная почта: org@eplast1.ru

Адрес: 198099, г. Санкт-Петербург, ул. Калинина, дом 2, корпус 4, литера А.