

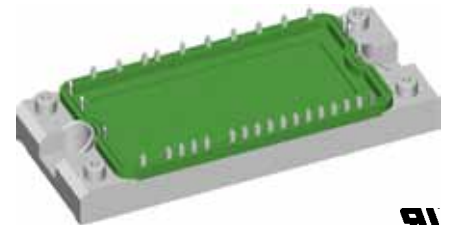
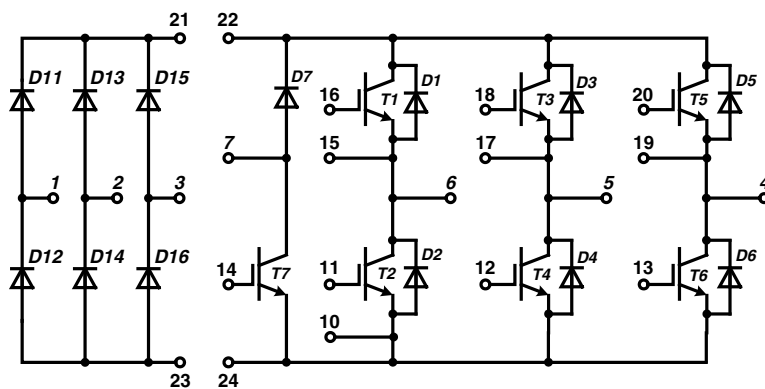
Converter - Brake - Inverter Module

XPT IGBT

Three Phase Rectifier	Brake Chopper	Three Phase Inverter
$V_{RRM} = 1600\text{ V}$	$V_{CES} = 1200\text{ V}$	$V_{CES} = 1200\text{ V}$
$I_{DAVM} = 105\text{ A}$	$I_{C25} = 28\text{ A}$	$I_{C25} = 60\text{ A}$
$I_{FSM} = 320\text{ A}$	$V_{CE(sat)} = 1.8\text{ V}$	$V_{CE(sat)} = 1.8\text{ V}$

Part name (Marking on product)

MIXA40WB1200TED



E 72873

Pin configuration see outlines.

Features:

- Easy paralleling due to the positive temperature coefficient of the on-state voltage
- Rugged XPT design (Xtreme light Punch Through) results in:
 - short circuit rated for 10 μsec .
 - very low gate charge
 - square RBSOA @ $3x I_C$
 - low EMI
- Thin wafer technology combined with the XPT design results in a competitive low $V_{CE(sat)}$
- SONIC™ diode
 - fast and soft reverse recovery
 - low operating forward voltage

Application:

- AC motor drives
- Solar inverter
- Medical equipment
- Uninterruptible power supply
- Air-conditioning systems
- Welding equipment
- Switched-mode and resonant-mode power supplies

Package:

- "E2-Pack" standard outline
- Insulated copper base plate
- Soldering pins for PCB mounting
- Temperature sense included

Output Inverter T1 - T6

Symbol	Definitions	Conditions	Ratings				
			min.	typ.	max.	Unit	
V_{CES}	collector emitter voltage		$T_{VJ} = 25^{\circ}\text{C}$		1200	V	
V_{GES}	max. DC gate voltage	continuous			± 20	V	
V_{GEM}	max. transient collector gate voltage	transient			± 30	V	
I_{C25}	collector current		$T_C = 25^{\circ}\text{C}$		60	A	
I_{C80}			$T_C = 80^{\circ}\text{C}$		40	A	
P_{tot}	total power dissipation		$T_C = 25^{\circ}\text{C}$		195	W	
$V_{CE(sat)}$	collector emitter saturation voltage	$I_C = 35\text{ A}; V_{GE} = 15\text{ V}$	$T_{VJ} = 25^{\circ}\text{C}$ $T_{VJ} = 125^{\circ}\text{C}$	1.8 2.1	2.1	V V	
$V_{GE(th)}$	gate emitter threshold voltage	$I_C = 1.5\text{ mA}; V_{GE} = V_{CE}$	$T_{VJ} = 25^{\circ}\text{C}$	5.4	6.0	6.5	V
I_{CES}	collector emitter leakage current	$V_{CE} = V_{CES}; V_{GE} = 0\text{ V}$	$T_{VJ} = 25^{\circ}\text{C}$ $T_{VJ} = 125^{\circ}\text{C}$		0.2	2.1 mA	mA mA
I_{GES}	gate emitter leakage current	$V_{GE} = \pm 20\text{ V}$			500	nA	
$Q_{G(on)}$	total gate charge	$V_{CE} = 600\text{ V}; V_{GE} = 15\text{ V}; I_C = 35\text{ A}$			106	nC	
$t_{d(on)}$	turn-on delay time	inductive load $V_{CE} = 600\text{ V}; I_C = 35\text{ A}$ $V_{GE} = \pm 15\text{ V}; R_G = 27\ \Omega$	$T_{VJ} = 125^{\circ}\text{C}$		70	ns	
t_r	current rise time				40	ns	
$t_{d(off)}$	turn-off delay time				250	ns	
t_f	current fall time				100	ns	
E_{on}	turn-on energy per pulse				3.8	mJ	
E_{off}	turn-off energy per pulse				4.1	mJ	
RBSOA	reverse bias safe operating area	$V_{GE} = \pm 15\text{ V}; R_G = 27\ \Omega;$	$T_{VJ} = 125^{\circ}\text{C}$ $V_{CEK} = 1200\text{ V}$		105	A	
SCSOA	short circuit safe operating area		$T_{VJ} = 125^{\circ}\text{C}$		10	μs	
t_{SC}	short circuit duration	$V_{CE} = 900\text{ V}; V_{GE} = \pm 15\text{ V};$ $R_G = 27\ \Omega;$ non-repetitive			140	A	
I_{SC}	short circuit current						
R_{thJC}	thermal resistance junction to case	(per IGBT)			0.64	K/W	

Output Inverter D1 - D6

Symbol	Definitions	Conditions	Ratings			
			min.	typ.	max.	Unit
V_{RRM}	max. repetitive reverse voltage		$T_{VJ} = 25^{\circ}\text{C}$		1200	V
I_{F25}	forward current		$T_C = 25^{\circ}\text{C}$		44	A
I_{F80}			$T_C = 80^{\circ}\text{C}$		29	A
V_F	forward voltage	$I_F = 30\text{ A}; V_{GE} = 0\text{ V}$	$T_{VJ} = 25^{\circ}\text{C}$ $T_{VJ} = 125^{\circ}\text{C}$	1.95 1.95	2.2	V V
Q_{rr}	reverse recovery charge	$V_R = 600\text{ V}$ $di_f/dt = -600\text{ A}/\mu\text{s}$ $I_F = 30\text{ A}; V_{GE} = 0\text{ V}$	$T_{VJ} = 125^{\circ}\text{C}$		3.5	μC
I_{RM}	max. reverse recovery current				30	A
t_{rr}	reverse recovery time				350	ns
E_{rec}	reverse recovery energy				0.9	mJ
R_{thJC}	thermal resistance junction to case	(per diode)			1.2	K/W

 $T_C = 25^{\circ}\text{C}$ unless otherwise stated

Brake T7

Symbol	Definitions	Conditions	Ratings			Unit	
			min.	typ.	max.		
V_{CES}	collector emitter voltage	$T_{VJ} = 25^{\circ}\text{C}$			1200	V	
V_{GES}	max. DC gate voltage	continuous			± 20	V	
V_{GEM}	max. transient collector gate voltage	transient			± 30	V	
I_{C25}	collector current	$T_C = 25^{\circ}\text{C}$			28	A	
I_{C80}		$T_C = 80^{\circ}\text{C}$			20	A	
P_{tot}	total power dissipation	$T_C = 25^{\circ}\text{C}$			100	W	
$V_{CE(sat)}$	collector emitter saturation voltage	$I_C = 16\text{ A}; V_{GE} = 15\text{ V}$			1.8 2.1	V V	
$V_{GE(th)}$	gate emitter threshold voltage	$I_C = 0.6\text{ mA}; V_{GE} = V_{CE}$	$T_{VJ} = 25^{\circ}\text{C}$	5.4	6.0	6.5	V
I_{CES}	collector emitter leakage current	$V_{CE} = V_{CES}; V_{GE} = 0\text{ V}$	$T_{VJ} = 25^{\circ}\text{C}$ $T_{VJ} = 125^{\circ}\text{C}$		0.1	0.1	mA mA
I_{GES}	gate emitter leakage current	$V_{GE} = \pm 20\text{ V}$				500	nA
$Q_{G(on)}$	total gate charge	$V_{CE} = 600\text{ V}; V_{GE} = 15\text{ V}; I_C = 15\text{ A}$			48		nC
$t_{d(on)}$	turn-on delay time	inductive load $V_{CE} = 600\text{ V}; I_C = 15\text{ A}$ $V_{GE} = \pm 15\text{ V}; R_G = 56\ \Omega$	$T_{VJ} = 125^{\circ}\text{C}$		70		ns
t_r	current rise time				40		ns
$t_{d(off)}$	turn-off delay time				250		ns
t_f	current fall time				100		ns
E_{on}	turn-on energy per pulse				1.6		mJ
E_{off}	turn-off energy per pulse				1.7		mJ
RBSOA	reverse bias safe operating area	$V_{GE} = \pm 15\text{ V}; R_G = 56\ \Omega;$	$T_{VJ} = 125^{\circ}\text{C}$ $V_{CEK} = 1200\text{ V}$			45	A
SCSOA	short circuit safe operating area		$T_{VJ} = 125^{\circ}\text{C}$				
t_{SC}	short circuit duration	$V_{CE} = 900\text{ V}; V_{GE} = \pm 15\text{ V};$				10	μs
I_{SC}	short circuit current	$R_G = 56\ \Omega;$ non-repetitive			60		A
R_{thJC}	thermal resistance junction to case	(per IGBT)				1.26	K/W

Brake Chopper D7

Symbol	Definitions	Conditions	Ratings			Unit	
			min.	typ.	max.		
V_{RRM}	max. repetitive reverse voltage	$T_{VJ} = 25^{\circ}\text{C}$			1200	V	
I_{F25}	forward current	$T_C = 25^{\circ}\text{C}$			12	A	
I_{F80}		$T_C = 80^{\circ}\text{C}$			8	A	
V_F	forward voltage	$I_F = 10\text{ A}; V_{GE} = 0\text{ V}$	$T_{VJ} = 25^{\circ}\text{C}$ $T_{VJ} = 125^{\circ}\text{C}$		2.5 2.6	2.9 V	V V
I_R	reverse current	$V_R = V_{RRM}$	$T_{VJ} = 25^{\circ}\text{C}$ $T_{VJ} = 125^{\circ}\text{C}$		0.5	0.5	mA mA
Q_{rr}	reverse recovery charge	$V_R = 600\text{ V}$ $di_F/dt = 200\text{ A}/\mu\text{s}$ $I_F = 5\text{ A}; V_{GE} = 0\text{ V}$	$T_{VJ} = 125^{\circ}\text{C}$		0.6		μC
I_{RM}	max. reverse recovery current				6		A
t_{rr}	reverse recovery time				350		ns
E_{rec}	reverse recovery energy				0.2		mJ
R_{thJC}	thermal resistance junction to case	(per diode)				3.4	K/W

 $T_C = 25^{\circ}\text{C}$ unless otherwise stated

Input Rectifier Bridge D11 - D16

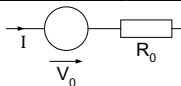
Symbol	Definitions	Conditions	Ratings			Unit
			min.	typ.	max.	
V_{RRM}	max. repetitive reverse voltage				1600	V
I_{FAV}	average forward current	sine 180°			37	A
I_{DAVM}	max. average DC output current	rect.; $d = 1/3$			105	A
I_{FSM}	max. forward surge current	$t = 10$ ms; sine 50 Hz			320	A
					280	A
I^2t	I^2t value for fusing	$t = 10$ ms; sine 50 Hz			510	A ² s
					390	A ² s
P_{tot}	total power dissipation				114	W
V_F	forward voltage	$I_F = 50$ A		1.34	1.7	V
				1.34		V
I_R	reverse current	$V_R = V_{RRM}$			0.02	mA
				0.2		mA
R_{thJC}	thermal resistance junction to case	(per diode)			1.1	K/W

Temperature Sensor NTC

Symbol	Definitions	Conditions	Ratings			Unit
			min.	typ.	max.	
R_{25}	resistance		4.75	5.0	5.25	k Ω
$B_{25/50}$				3375		K

Module

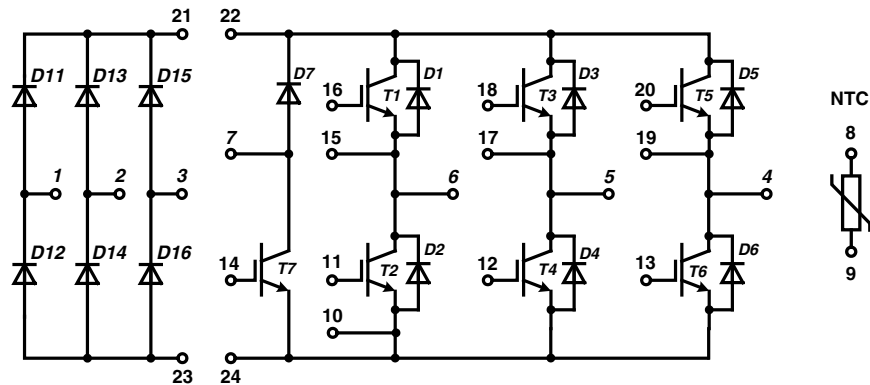
Symbol	Definitions	Conditions	Ratings			Unit
			min.	typ.	max.	
T_{VJ}	operating temperature		-40		125	°C
T_{VJM}	max. virtual junction temperature				150	°C
T_{stg}	storage temperature		-40		125	°C
V_{ISOL}	isolation voltage	$I_{ISOL} \leq 1$ mA; 50/60 Hz			2500	V~
CTI	comparative tracking index				-	
M_d	mounting torque (M5)		3		6	Nm
d_S	creep distance on surface		6			mm
d_A	strike distance through air		6			mm
$R_{pin-chip}$	resistance pin to chip			5		m Ω
R_{thCH}	thermal resistance case to heatsink	with heatsink compound		0.02		K/W
Weight				180		g

Equivalent Circuits for Simulation


Symbol	Definitions	Conditions	Ratings			Unit
			min.	typ.	max.	
V_0	rectifier diode	D8 - D13			0.88	V
R_0					9	m Ω
V_0	IGBT	T1 - T6			1.1	V
R_0					40	m Ω
V_0	free wheeling diode	D1 - D6			1.2	V
R_0					27	m Ω
V_0	IGBT	T7			1.1	V
R_0					86	m Ω
V_0	free wheeling diode	D7			1.15	V
R_0					170	m Ω

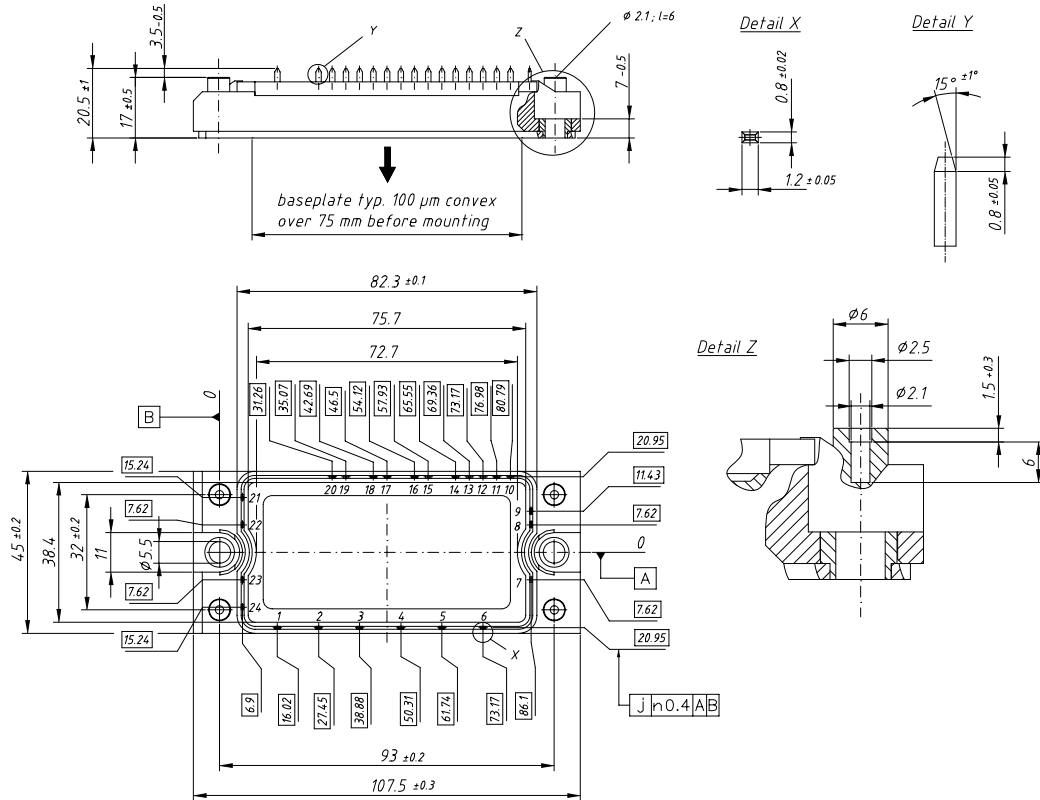
 $T_C = 25^\circ\text{C}$ unless otherwise stated

Circuit Diagram

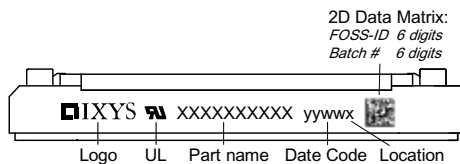


Outline Drawing

Dimensions in mm (1 mm = 0.0394")



Product Marking



2D Data Matrix:
FOSS-ID 6 digits
Batch # 6 digits

Part number

- M = Module
- I = IGBT
- X = XPT
- A = Standard
- 40 = Current Rating [A]
- WB = 6-Pack + 3~ Rectifier Bridge & Brake Unit
- 1200 = Reverse Voltage [V]
- T = NTC
- ED = E2-Pack

Ordering	Part Name	Marking on Product	Delivering Mode	Base Qty	Ordering Code
Standard	MIXA40WB1200 TED	MIXA40WB1200TED	Box	6	507497

Inverter T1 - T6

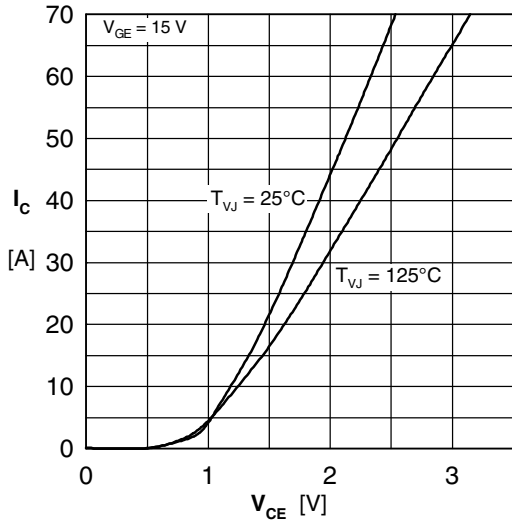


Fig. 1 Typ. output characteristics

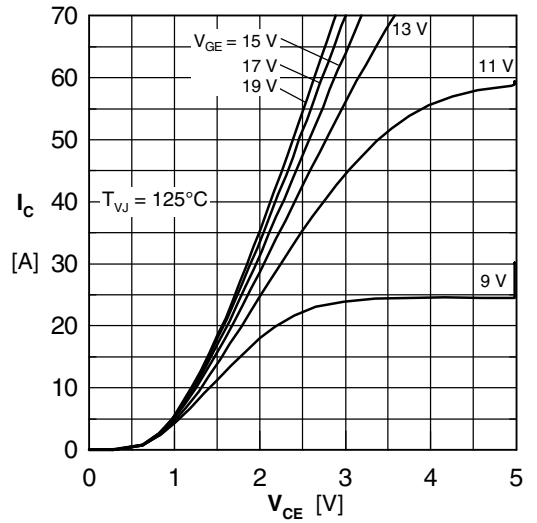


Fig. 2 Typ. output characteristics

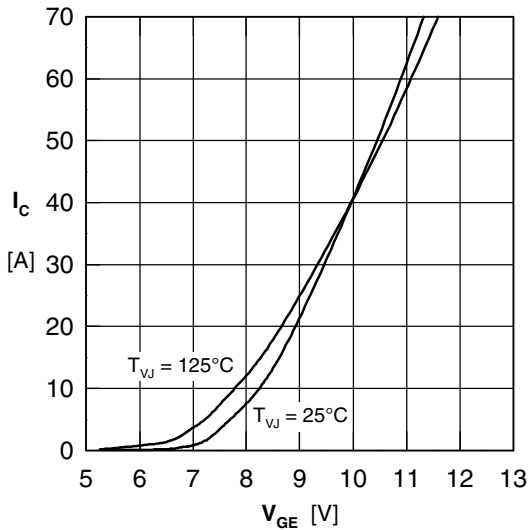


Fig. 3 Typ. transfer characteristics

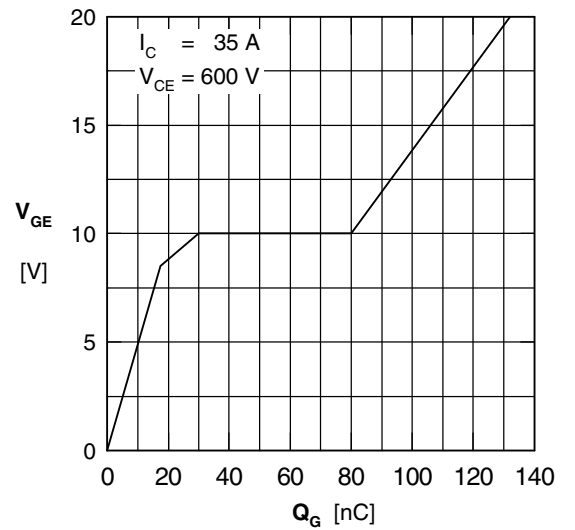


Fig. 4 Typ. turn-on gate charge

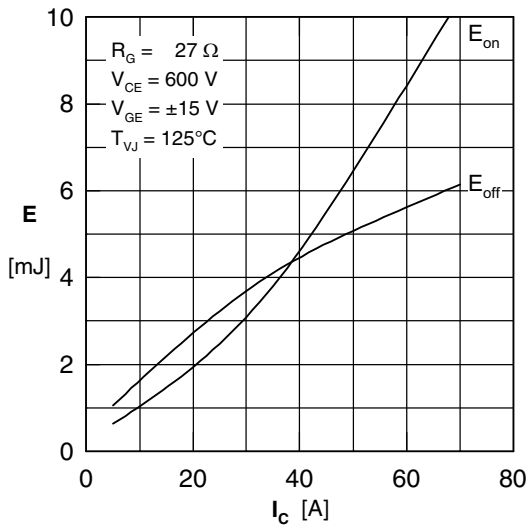


Fig. 5 Typ. switching energy vs. collector current

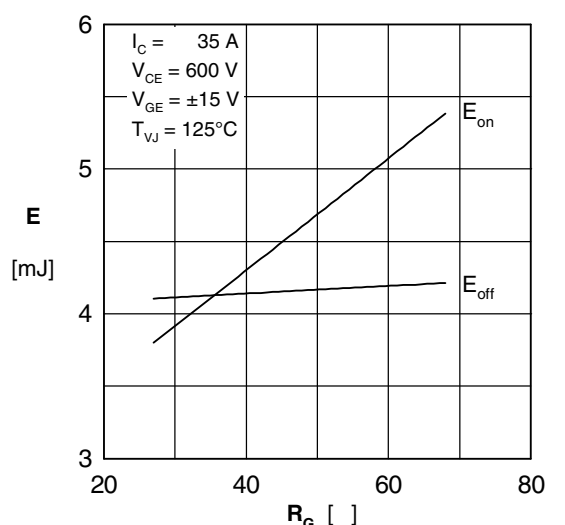


Fig. 6 Typ. switching energy vs. gate resistance

Inverter D1 - D6

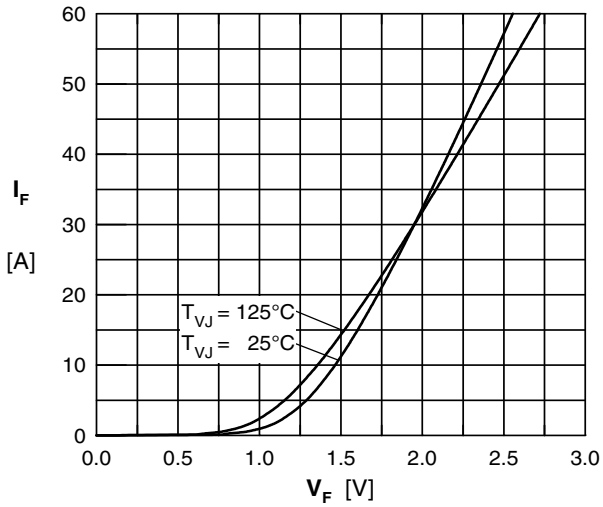


Fig. 7 Typ. Forward current versus V_F

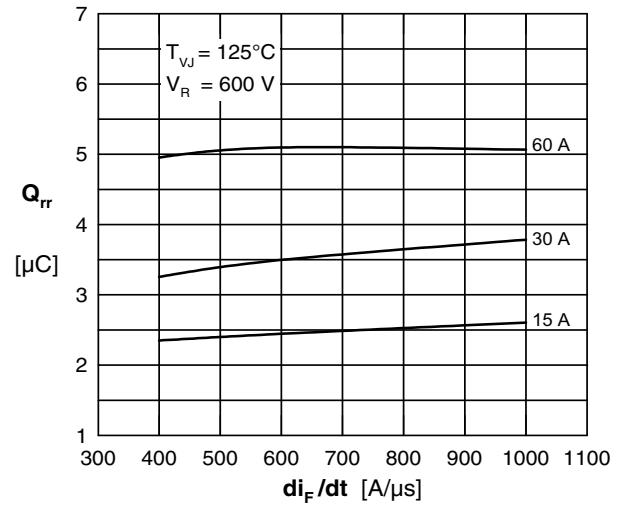


Fig. 8 Typ. reverse recov.charge Q_{rr} vs. di/dt

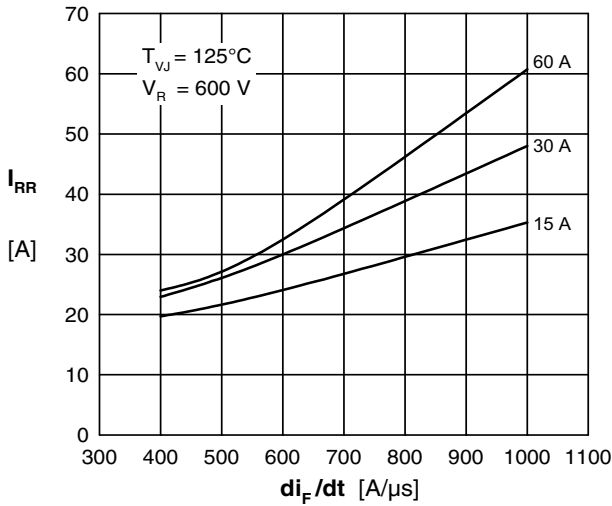


Fig. 9 Typ. peak reverse current I_{RM} vs. di/dt

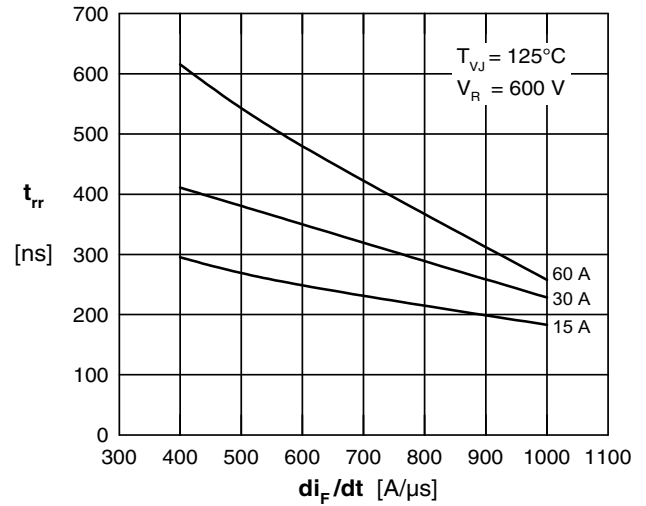


Fig. 10 Typ. recovery time t_{rr} versus di/dt

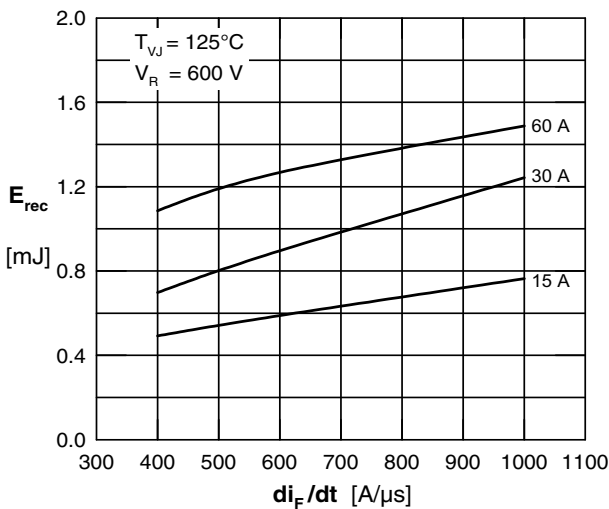


Fig. 5 Typ. recovery energy E_{rec} versus di/dt

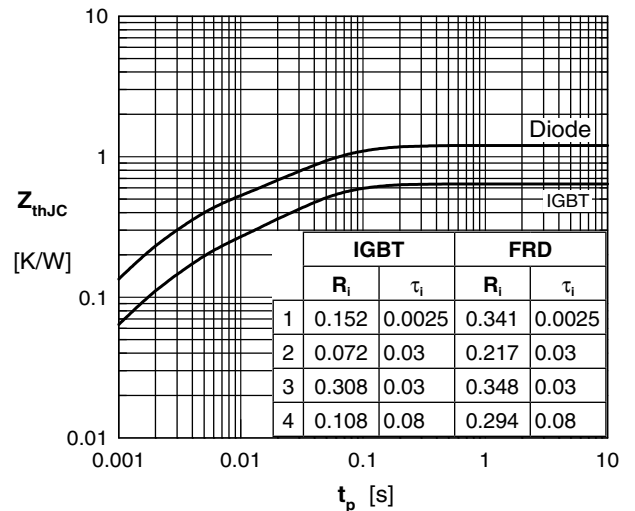


Fig. 12 Typ. transient thermal impedance

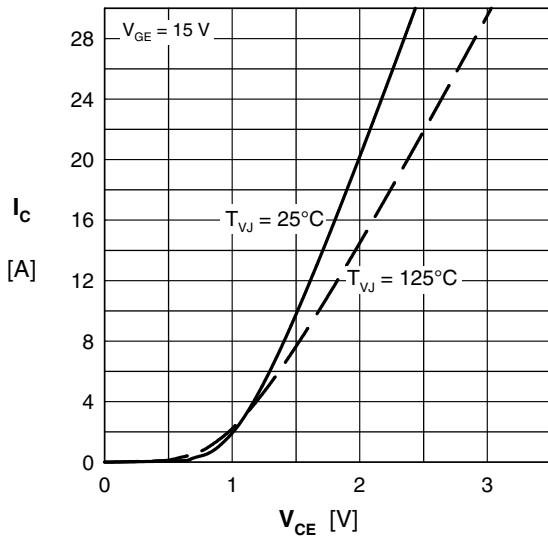
Brake T7 & D7


Fig. 13 Typ. output characteristics

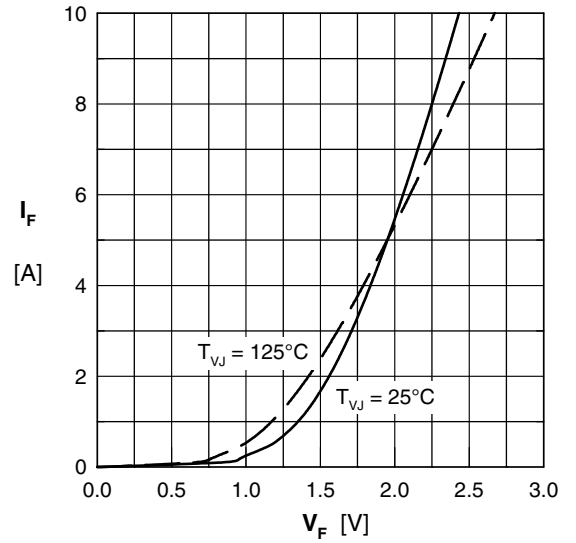


Fig. 14 Typ. forward characteristics

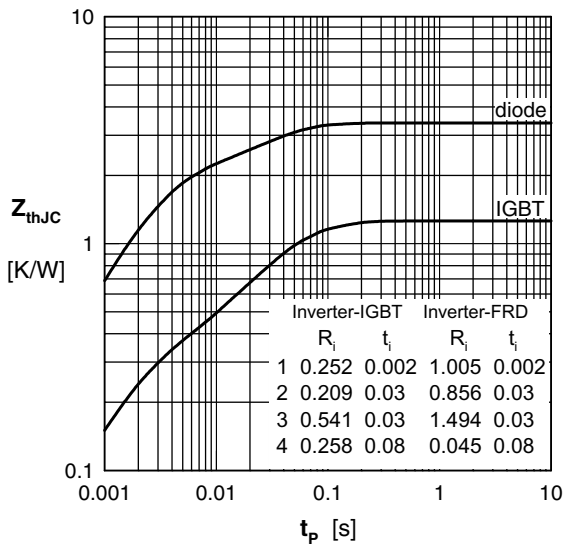


Fig. 15 Typ. transient thermal impedance

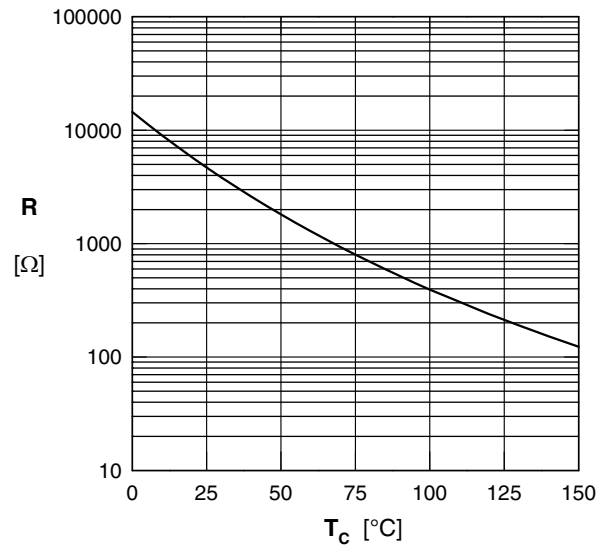


Fig. 16 Typ. NTC resistance vs. temperature



Компания «ЭлектроПласт» предлагает заключение долгосрочных отношений при поставках импортных электронных компонентов на взаимовыгодных условиях!

Наши преимущества:

- Оперативные поставки широкого спектра электронных компонентов отечественного и импортного производства напрямую от производителей и с крупнейших мировых складов;
- Поставка более 17-ти миллионов наименований электронных компонентов;
- Поставка сложных, дефицитных, либо снятых с производства позиций;
- Оперативные сроки поставки под заказ (от 5 рабочих дней);
- Экспресс доставка в любую точку России;
- Техническая поддержка проекта, помощь в подборе аналогов, поставка прототипов;
- Система менеджмента качества сертифицирована по Международному стандарту ISO 9001;
- Лицензия ФСБ на осуществление работ с использованием сведений, составляющих государственную тайну;
- Поставка специализированных компонентов (Xilinx, Altera, Analog Devices, Intersil, Interpoint, Microsemi, Aeroflex, Peregrine, Syfer, Eurofarad, Texas Instrument, Miteq, Cobham, E2V, MA-COM, Hittite, Mini-Circuits, General Dynamics и др.);

Помимо этого, одним из направлений компании «ЭлектроПласт» является направление «Источники питания». Мы предлагаем Вам помощь Конструкторского отдела:

- Подбор оптимального решения, техническое обоснование при выборе компонента;
- Подбор аналогов;
- Консультации по применению компонента;
- Поставка образцов и прототипов;
- Техническая поддержка проекта;
- Защита от снятия компонента с производства.



Как с нами связаться

Телефон: 8 (812) 309 58 32 (многоканальный)

Факс: 8 (812) 320-02-42

Электронная почта: org@eplast1.ru

Адрес: 198099, г. Санкт-Петербург, ул. Калинина, дом 2, корпус 4, литера А.