

High Voltage Isolator

OPI1268



Features:

- TTL compatible output
- 16 kV dc isolation
- 2Mbit/s
- $t_{PHL}-t_{PLH} \leq 500$ ns
- Creepage path: 0.970" (24.64 mm)
- Air path: 0.970" (24.64 mm)
- UL recognized file No. E58730



Description:

The **OPI1268** is a high voltage isolator with a digital output that is capable of high speed data transmission. The input of the OPI1268 consists of a high-efficiency GaAlAs LED with a peak wavelength of 850 nm, which is optically coupled to the output optical IC. A photodiode in the output IC detects the incoming modulated light and converts it to a proportionate current. This current is fed into a high-gain linear amplifier which is temperature, current and voltage compensated. The result is a highly stable digital output with an open collector inverter configuration. This device produces DC and AC voltage isolation between the input and output circuitry while providing TTL signal integrity.

Applications:

- Data transmission for High voltage isolation
- PCBoard power system isolation
- Industrial equipment power isolation
- Medical equipment power isolation
- Office equipment

Ordering Information							
Part Number	LED Peak Wavelength	Sensor Photologic®	Isolation Voltage kVDC	t_{PLH} / t_{PHL} Max (ns)	I_f (mA) Typ / Max	V_{CE} (V) Max	Lead Length / Spacing
OPI1268	850 nm	Open Collector	16	100 / 200	10 / 50	18	0.12" / 0.98"

Pin	Function
1	Cathode
2	Anode
3	Vcc
4	Output
5	Ground

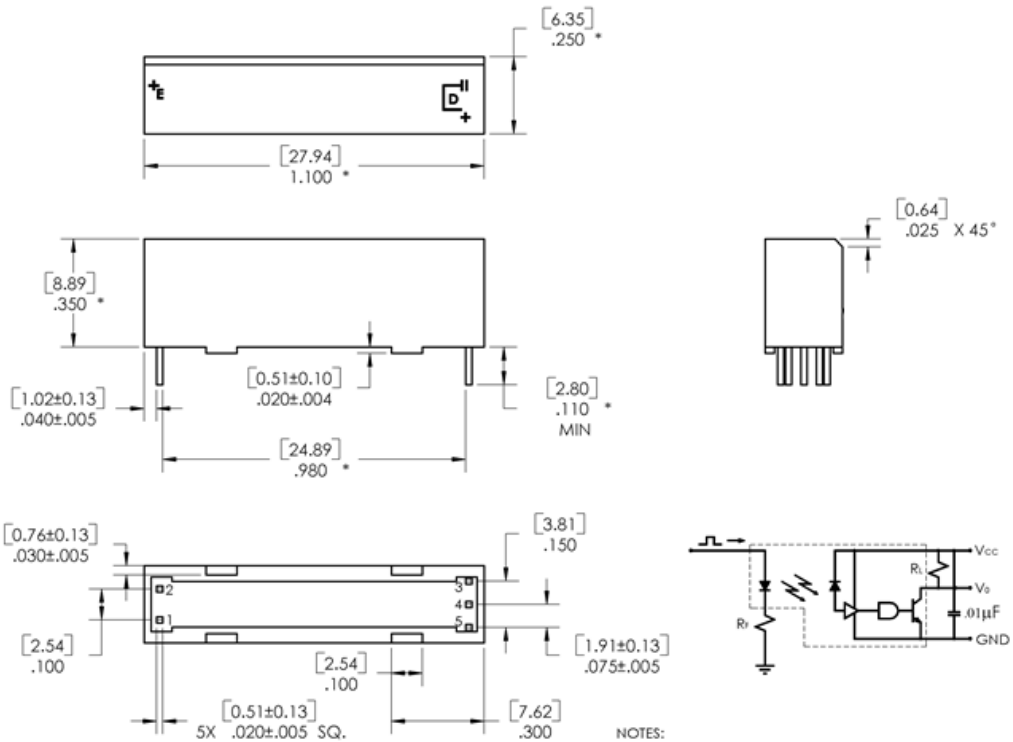

General Note
TT Electronics reserves the right to make changes in product specification without notice or liability. All information is subject to TT Electronics' own data and is considered accurate at time of going to print.

TT Electronics | OPTEK Technology
1645 Wallace Drive, Carrollton, TX 75006 | Ph: +1 972 323 2200
www.ttelectronics.com | sensors@ttelectronics.com

High Voltage Isolator

OPI1268



Absolute Maximum Ratings ($T_A = 25^\circ\text{C}$ unless otherwise noted)

Storage Temperature	-40° C to +100° C
Operating Temperature	-40° C to +100° C
Input-to-Output Isolation Voltage ⁽²⁾	16 kVDC
Lead Soldering Temperature (1/16" (1.6 mm) from case for 5 seconds with soldering iron) ⁽³⁾	260° C
Input Diode	
Continuous Forward Current	30 mA
Peak Forward current (1 μs pulse width, 300 pps)	3.0 A
Reverse Voltage	3.0 V
Power Dissipation ⁽¹⁾	100 mW
Output IC	
Maximum Supply Voltage	7 V
Power Dissipation ⁽⁴⁾	40 mW
Maximum Output Voltage	18 V
Maximum Output Current	25 mA

Electrical Characteristics ($T_A = 0^\circ\text{C}$ to 70°C unless otherwise noted)

SYMBOL	PARAMETER	MIN	TYP	MAX	UNITS	TEST CONDITIONS
Input Diode						
V_F	Forward Voltage	-	1.3	1.6	V	$I_F = 20\text{ mA}$
I_R	Reverse Current	-	0.1	100	μA	$V_R = 2.0\text{ V}$
Output IC ($V_{CC} = 4.5\text{ V}$ to 5.25 V) (See OPL550 for additional information—for reference only.)						
I_{OH}	High Level Output Current	-	0.20	10	μA	$I_F = 0.0\text{ mA}$, $V_{OH} = 18.0\text{ V}$, $V_{CC} = 5.25\text{ V}$
V_{OL}	Low Level Output Voltage	-	0.44	0.55	V	$I_F = 10.0\text{ mA}$, $I_{OL} = 8.0\text{ mA}$, $V_{CC} = 4.5\text{ V}$
I_{CCH}	High Level Supply Current	-	4.2	7	mA	$I_F = 0$, $V_{CC} = 5.25\text{ V}$
I_{CCL}	Low Level Supply Current	-	6.7	10		$I_F = 10.0\text{ mA}$, $V_{CC} = 5.25\text{ V}$
Coupled Characteristics ($V_{CC} = 5\text{ V}$)						
C_{IO}	Coupling Capacitance	-	-	2	pF	Input and output leads shorted.
t_{PLH}	Propagation Delay to Low Output Level	-	-	200	ns	$V_{CC}=5\text{V}$, $I_F=30\text{mA}$, $R_L=560\Omega$
t_{PHL}	Propagation Delay to High Output Level	-	-	100		
I_{ISO}	Isolation Leakage Current ⁽⁵⁾	-	-	20	μA	$V_{ISO} = 19.2\text{ kV dc}$
I_{F+}	LED Positive Going Threshold Current	0.8	1.7	5.0	mA	$V_{CC} = 5\text{ V}$, $I_{OL} = 8.0\text{ mA}$

Notes:

- (1) Derate LED linearly 1.33 mW/°C above 25°C.
- (2) UL recognition is for 16kV dc for one minute.
- (3) RMA flux is recommended. The duration can be extended to 10 seconds maximum when flow soldering.
- (4) Derate linearly 0.54m W/°C above 25°C.
- (5) Measured with input leads shorted together and output leads shorted together in air with a maximum relative humidity of 50%.

General Note

TT Electronics reserves the right to make changes in product specification without notice or liability. All information is subject to TT Electronics' own data and is considered accurate at time of going to print.

TT Electronics | OPTEK Technology
1645 Wallace Drive, Carrollton, TX 75006 | Ph: +1 972 323 2200
www.ttelectronics.com | sensors@ttelectronics.com

High Voltage Isolator

OPI1268

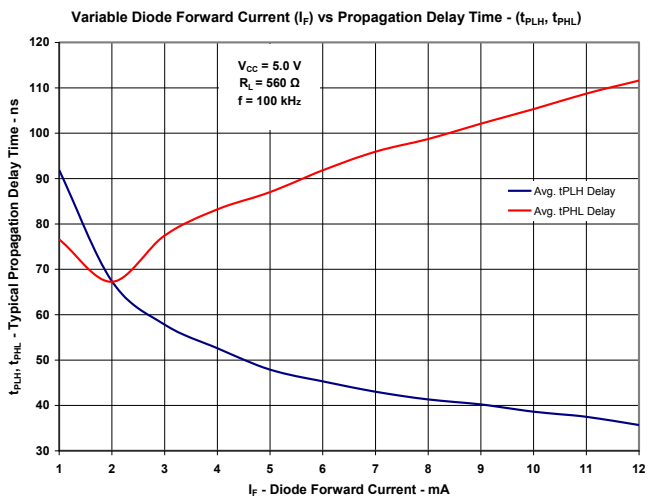
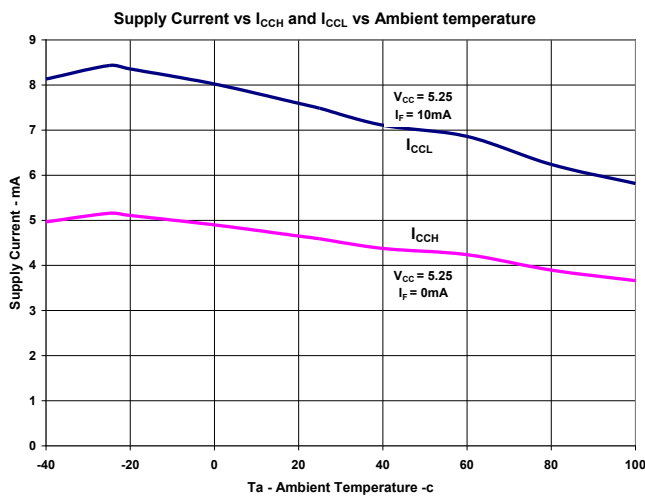
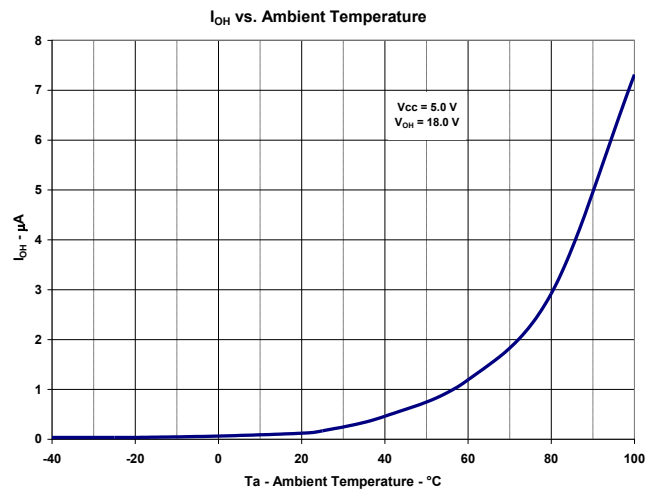
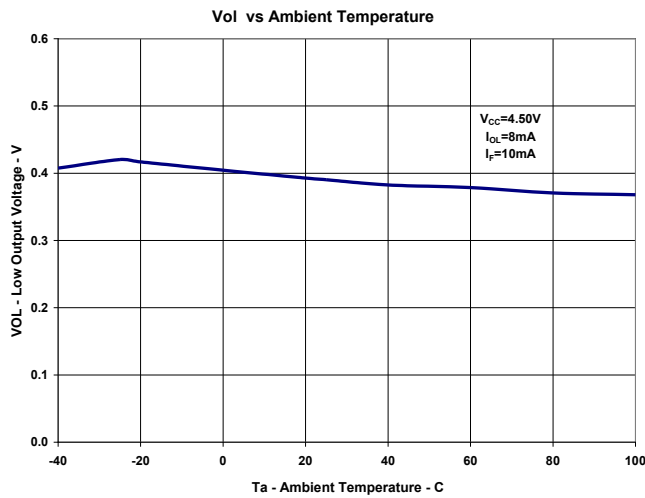
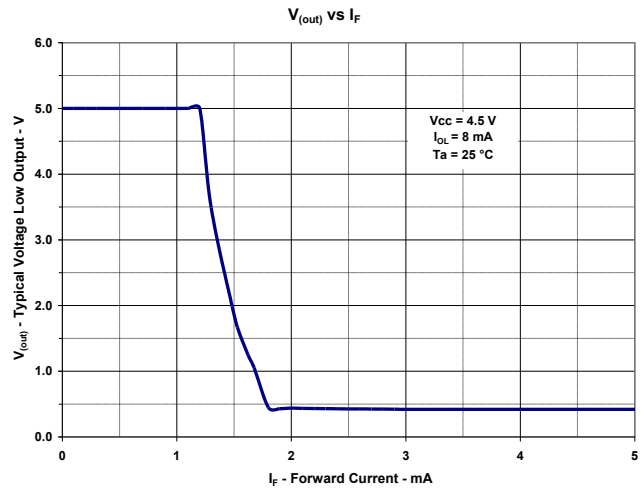
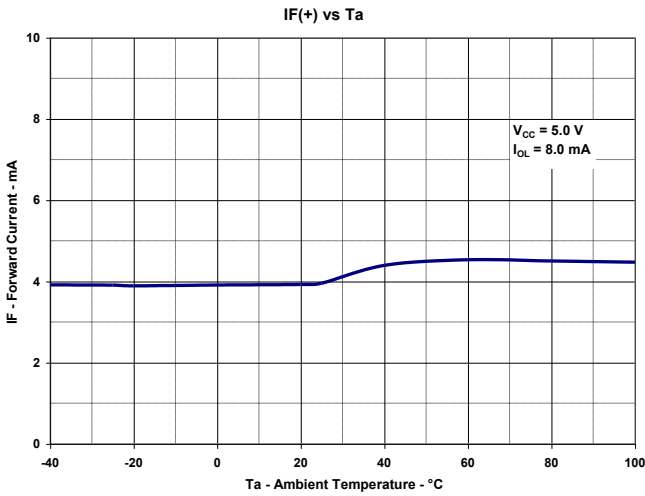

General Note
TT Electronics reserves the right to make changes in product specification without notice or liability. All information is subject to TT Electronics' own data and is considered accurate at time of going to print.

TT Electronics | OPTEK Technology
1645 Wallace Drive, Carrollton, TX 75006 | Ph: +1 972 323 2200
www.ttelectronics.com | sensors@ttelectronics.com

High Voltage Isolator

OPI1268



dV/dT

OPI1268 dV/dT Emitter

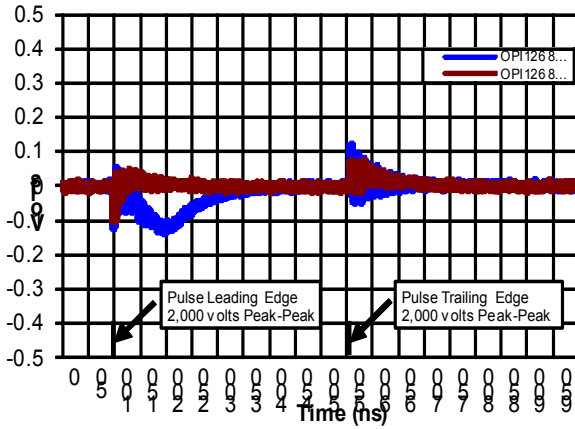

OPI1268 dV/dT Sensor

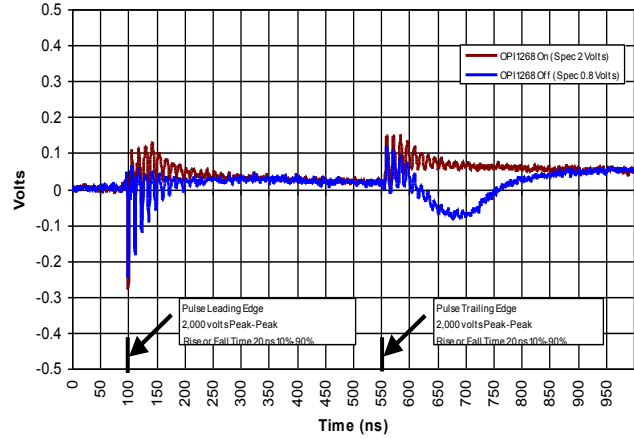

General Note

TT Electronics reserves the right to make changes in product specification without notice or liability. All information is subject to TT Electronics' own data and is considered accurate at time of going to print.

TT Electronics | OPTEK Technology
1645 Wallace Drive, Carrollton, TX 75006 | Ph: +1 972 323 2200
www.ttelectronics.com | sensors@ttelectronics.com



Компания «ЭлектроПласт» предлагает заключение долгосрочных отношений при поставках импортных электронных компонентов на взаимовыгодных условиях!

Наши преимущества:

- Оперативные поставки широкого спектра электронных компонентов отечественного и импортного производства напрямую от производителей и с крупнейших мировых складов;
- Поставка более 17-ти миллионов наименований электронных компонентов;
- Поставка сложных, дефицитных, либо снятых с производства позиций;
- Оперативные сроки поставки под заказ (от 5 рабочих дней);
- Экспресс доставка в любую точку России;
- Техническая поддержка проекта, помощь в подборе аналогов, поставка прототипов;
- Система менеджмента качества сертифицирована по Международному стандарту ISO 9001;
- Лицензия ФСБ на осуществление работ с использованием сведений, составляющих государственную тайну;
- Поставка специализированных компонентов (Xilinx, Altera, Analog Devices, Intersil, Interpoint, Microsemi, Aeroflex, Peregrine, Syfer, Eurofarad, Texas Instrument, Miteq, Cobham, E2V, MA-COM, Hittite, Mini-Circuits, General Dynamics и др.);

Помимо этого, одним из направлений компании «ЭлектроПласт» является направление «Источники питания». Мы предлагаем Вам помощь Конструкторского отдела:

- Подбор оптимального решения, техническое обоснование при выборе компонента;
- Подбор аналогов;
- Консультации по применению компонента;
- Поставка образцов и прототипов;
- Техническая поддержка проекта;
- Защита от снятия компонента с производства.



Как с нами связаться

Телефон: 8 (812) 309 58 32 (многоканальный)

Факс: 8 (812) 320-02-42

Электронная почта: org@eplast1.ru

Адрес: 198099, г. Санкт-Петербург, ул. Калинина, дом 2, корпус 4, литера А.