

74AUP1T97

Low-power configurable gate with voltage-level translator

Rev. 6 — 28 March 2017

Product data sheet

1 General description

The 74AUP1T97 provides low-power, low-voltage configurable logic gate functions. The output state is determined by eight patterns of 3-bit input. The user can choose the logic functions MUX, AND, OR, NAND, NOR, inverter and buffer. All inputs can be connected to V_{CC} or GND.

This device ensures a very low static and dynamic power consumption across the entire V_{CC} range from 2.3 V to 3.6 V.

The 74AUP1T97 is designed for logic-level translation applications with input switching levels that accept 1.8 V low-voltage CMOS signals, while operating from either a single 2.5 V or 3.3 V supply voltage.

The wide supply voltage range ensures normal operation as battery voltage drops from 3.6 V to 2.3 V.

This device is fully specified for partial power-down applications using I_{OFF} . The I_{OFF} circuitry disables the output, preventing the damaging backflow current through the device when it is powered down.

Schmitt trigger inputs make the circuit tolerant to slower input rise and fall times across the entire V_{CC} range.

2 Features and benefits

- Wide supply voltage range from 2.3 V to 3.6 V
- High noise immunity
- ESD protection:
 - HBM JESD22-A114F Class 3A exceeds 5 000 V
 - MM JESD22-A115-A exceeds 200 V
 - CDM JESD22-C101E exceeds 1 000 V
- Low static power consumption; $I_{CC} = 1.5 \mu\text{A}$ (maximum)
- Latch-up performance exceeds 100 mA per JESD 78 Class II
- Inputs accept voltages up to 3.6 V
- Low noise overshoot and undershoot $< 10\%$ of V_{CC}
- I_{OFF} circuitry provides partial power-down mode operation
- Multiple package options
- Specified from $-40\text{ }^\circ\text{C}$ to $+85\text{ }^\circ\text{C}$ and $-40\text{ }^\circ\text{C}$ to $+125\text{ }^\circ\text{C}$

3 Ordering information

Table 1. Ordering information

Type number	Package			Version
	Temperature range	Name	Description	
74AUP1T97GW	-40 °C to +125 °C	SC-88	plastic surface-mounted package; 6 leads	SOT363
74AUP1T97GM	-40 °C to +125 °C	XSON6	plastic extremely thin small outline package; no leads; 6 terminals; body 1 x 1.45 x 0.5 mm	SOT886
74AUP1T97GF	-40 °C to +125 °C	XSON6	plastic extremely thin small outline package; no leads; 6 terminals; body 1 x 1 x 0.5 mm	SOT891
74AUP1T97GN	-40 °C to +125 °C	XSON6	extremely thin small outline package; no leads; 6 terminals; body 0.9 x 1.0 x 0.35 mm	SOT1115
74AUP1T97GS	-40 °C to +125 °C	XSON6	extremely thin small outline package; no leads; 6 terminals; body 1.0 x 1.0 x 0.35 mm	SOT1202
74AUP1T97GX	-40 °C to +125 °C	X2SON6	plastic thermal extremely thin small outline package; no leads; 6 terminals; body 1 x 0.8 x 0.35 mm	SOT1255
74AUP1T97UK	-40 °C to +125 °C	WLCSP6	wafer level chip-scale package; 6 bumps; 0.65 x 0.44 x 0.27 mm	SOT1454-1

4 Marking

Table 2. Marking

Type number	Marking code ^[1]
74AUP1T97GW	59
74AUP1T97GM	59
74AUP1T97GF	59
74AUP1T97GN	59
74AUP1T97GS	59
74AUP1T97GX	59
74AUP1T97UK	9

[1] The pin 1 indicator is located on the lower left corner of the device, below the marking code.

5 Pinning information

5.1 Pinning

Table 3. Pinning

<p style="text-align: center;">74AUP1T97</p> <p style="text-align: center;">001aag500</p>	<p style="text-align: center;">74AUP1T97</p> <p style="text-align: center;">001aag501</p> <p style="text-align: center;">Transparent top view</p>
<p style="text-align: center;">74AUP1T97</p> <p style="text-align: center;">001aag502</p> <p style="text-align: center;">Transparent top view</p>	<p style="text-align: center;">74AUP1T97</p> <p style="text-align: center;">aaa-019832</p> <p style="text-align: center;">Transparent top view</p>
<p style="text-align: center;">74AUP1T97UK</p> <p style="text-align: center;">ball A1 index area</p> <p style="text-align: center;">aaa-018292</p> <p style="text-align: center;">Transparent top view</p>	<p style="text-align: center;">74AUP1T97UK</p> <p style="text-align: center;">aaa-018293</p> <p style="text-align: center;">Transparent top view</p>

5.2 Pin description

Table 4. Pin description

Symbol	Pin		Description
	SC88, XSON6 and X2SON6	WLCSP6	
B	1	A1	data input
GND	2	B1	ground (0 V)
A	3	C1	data input
Y	4	C2	data output
V _{CC}	5	B2	supply voltage
C	6	A2	data input

6 Functional description

Table 5. Function table ^[1]

Input			Output
C	B	A	Y
L	L	L	L
L	L	H	L
L	H	L	H
L	H	H	H
H	L	L	L
H	L	H	H
H	H	L	L
H	H	H	H

[1] H = HIGH voltage level; L = LOW voltage level.

7 Functional diagram

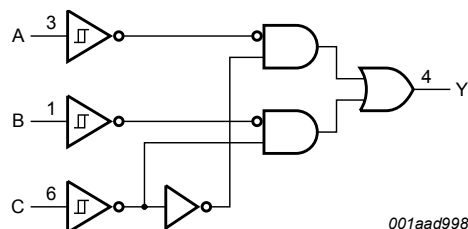

Figure 7. Logic symbol

8 Logic configurations

Table 6. Function selection table

Logic function	Figure
2-input MUX	see Figure 8
2-input AND	see Figure 9
2-input OR with one input inverted	see Figure 10
2-input NAND with one input inverted	see Figure 10
2-input AND with one input inverted	see Figure 11
2-input NOR with one input inverted	see Figure 11
2-input OR	see Figure 12
Inverter	see Figure 13
Buffer	see Figure 14

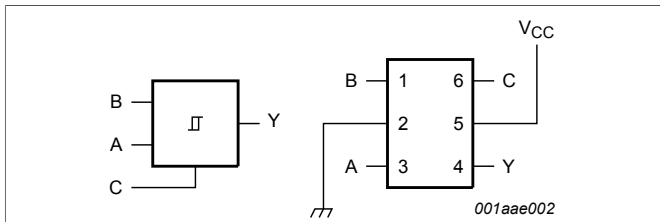

Figure 8. 2-input MUX

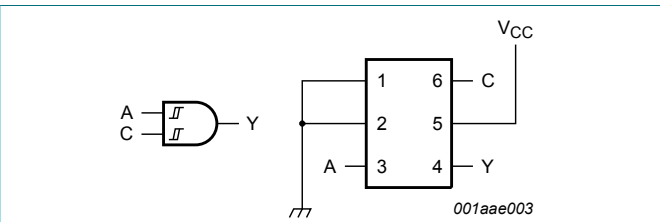

Figure 9. 2-input AND gate

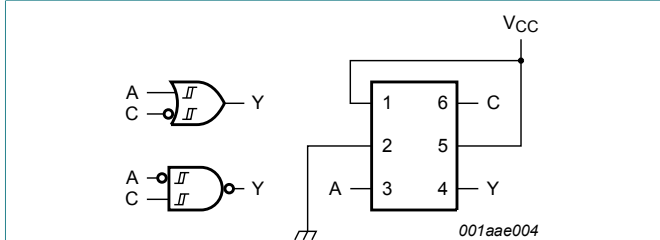

Figure 10. 2-input NAND gate with input A inverted or 2-input OR gate with input C inverted

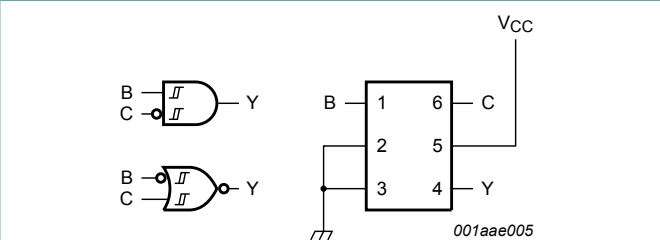

Figure 11. 2-input NOR gate with input B inverted or 2-input AND gate with input C inverted

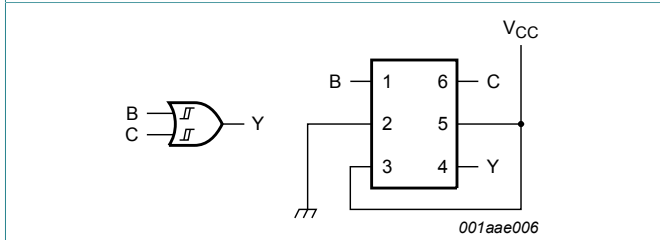

Figure 12. 2-input OR gate

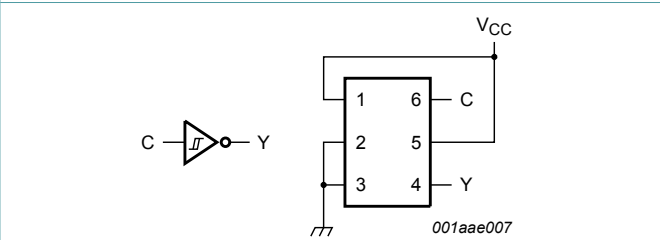

Figure 13. Inverter

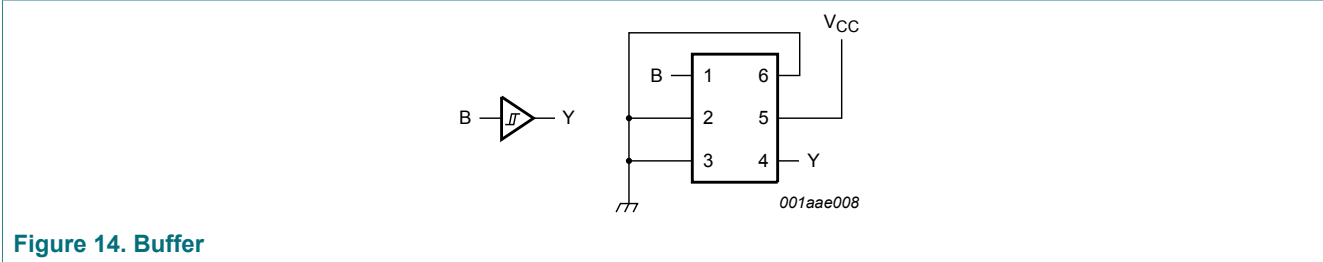

Figure 14. Buffer

9 Limiting values

Table 7. Limiting values

In accordance with the Absolute Maximum Rating System (IEC 60134). Voltages are referenced to GND (ground = 0 V).

Symbol	Parameter	Conditions	Min	Max	Unit
V_{CC}	supply voltage		-0.5	+4.6	V
I_{IK}	input clamping current	$V_I < 0$ V	-50	-	mA
V_I	input voltage		[1] -0.5	+4.6	V
I_{OK}	output clamping current	$V_O < 0$ V	-50	-	mA
V_O	output voltage	Active mode and Power-down mode	[1] -0.5	+4.6	V
I_O	output current	$V_O = 0$ V to V_{CC}	-	±20	mA
I_{CC}	supply current		-	50	mA
I_{GND}	ground current		-50	-	mA
T_{stg}	storage temperature		-65	+150	°C
P_{tot}	total power dissipation	$T_{amb} = -40$ °C to +125 °C	[2] -	250	mW

[1] The minimum input and output voltage ratings may be exceeded if the input and output current ratings are observed.

[2] For SC-88 package: above 87.5 °C the value of P_{tot} derates linearly with 4.0 mW/K.
 For X2SON6 and XSON6 packages: above 118 °C the value of P_{tot} derates linearly with 7.8 mW/K.
 For WLCSP6 package: above 102.5 °C the value of P_{tot} derates linearly with 5.3 mW/K.

10 Recommended operating conditions

Table 8. Recommended operating conditions

Symbol	Parameter	Conditions	Min	Max	Unit
V_{CC}	supply voltage		2.3	3.6	V
V_I	input voltage		0	3.6	V
V_O	output voltage	Active mode	0	V_{CC}	V
		Power-down mode; $V_{CC} = 0$ V	0	3.6	V
T_{amb}	ambient temperature		-40	+125	°C

11 Static characteristics

Table 9. Static characteristics

At recommended operating conditions; voltages are referenced to GND (ground = 0 V).

Symbol	Parameter	Conditions	Min	Typ	Max	Unit
$T_{amb} = 25\text{ }^{\circ}\text{C}$						
V_{T+}	positive-going threshold voltage	$V_{CC} = 2.3\text{ V to }2.7\text{ V}$	0.60	-	1.10	V
		$V_{CC} = 3.0\text{ V to }3.6\text{ V}$	0.75	-	1.16	V
V_{T-}	negative-going threshold voltage	$V_{CC} = 2.3\text{ V to }2.7\text{ V}$	0.35	-	0.60	V
		$V_{CC} = 3.0\text{ V to }3.6\text{ V}$	0.50	-	0.85	V
V_H	hysteresis voltage	$(V_H = V_{T+} - V_{T-})$				
		$V_{CC} = 2.3\text{ V to }2.7\text{ V}$	0.23	-	0.60	V
		$V_{CC} = 3.0\text{ V to }3.6\text{ V}$	0.25	-	0.56	V
V_{OH}	HIGH-level output voltage	$V_I = V_{T+}$ or V_{T-}				
		$I_O = -20\text{ }\mu\text{A}$; $V_{CC} = 2.3\text{ V to }3.6\text{ V}$	$V_{CC} - 0.1$	-	-	V
		$I_O = -2.3\text{ mA}$; $V_{CC} = 2.3\text{ V}$	2.05	-	-	V
		$I_O = -3.1\text{ mA}$; $V_{CC} = 2.3\text{ V}$	1.9	-	-	V
		$I_O = -2.7\text{ mA}$; $V_{CC} = 3.0\text{ V}$	2.72	-	-	V
		$I_O = -4.0\text{ mA}$; $V_{CC} = 3.0\text{ V}$	2.6	-	-	V
V_{OL}	LOW-level output voltage	$V_I = V_{T+}$ or V_{T-}				
		$I_O = 20\text{ }\mu\text{A}$; $V_{CC} = 2.3\text{ V to }3.6\text{ V}$	-	-	0.10	V
		$I_O = 2.3\text{ mA}$; $V_{CC} = 2.3\text{ V}$	-	-	0.31	V
		$I_O = 3.1\text{ mA}$; $V_{CC} = 2.3\text{ V}$	-	-	0.44	V
		$I_O = 2.7\text{ mA}$; $V_{CC} = 3.0\text{ V}$	-	-	0.31	V
		$I_O = 4.0\text{ mA}$; $V_{CC} = 3.0\text{ V}$	-	-	0.44	V
I_I	input leakage current	$V_I = \text{GND to }3.6\text{ V}$; $V_{CC} = 0\text{ V to }3.6\text{ V}$	-	-	± 0.1	μA
I_{OFF}	power-off leakage current	V_I or $V_O = 0\text{ V to }3.6\text{ V}$; $V_{CC} = 0\text{ V}$	-	-	± 0.1	μA
ΔI_{OFF}	additional power-off leakage current	V_I or $V_O = 0\text{ V to }3.6\text{ V}$; $V_{CC} = 0\text{ V to }0.2\text{ V}$	-	-	± 0.2	μA
I_{CC}	supply current	$V_I = \text{GND or }V_{CC}$; $I_O = 0\text{ A}$; $V_{CC} = 2.3\text{ V to }3.6\text{ V}$	-	-	1.2	μA
C_I	input capacitance	$V_{CC} = 0\text{ V to }3.6\text{ V}$; $V_I = \text{GND or }V_{CC}$	-	0.8	-	pF
C_O	output capacitance	$V_O = \text{GND}$; $V_{CC} = 0\text{ V}$	-	1.7	-	pF
$T_{amb} = -40\text{ }^{\circ}\text{C to }+85\text{ }^{\circ}\text{C}$						
V_{T+}	positive-going threshold voltage	$V_{CC} = 2.3\text{ V to }2.7\text{ V}$	0.60	-	1.10	V
		$V_{CC} = 3.0\text{ V to }3.6\text{ V}$	0.75	-	1.19	V

Symbol	Parameter	Conditions	Min	Typ	Max	Unit
V _{T-}	negative-going threshold voltage	V _{CC} = 2.3 V to 2.7 V	0.35	-	0.60	V
		V _{CC} = 3.0 V to 3.6 V	0.50	-	0.85	V
V _H	hysteresis voltage	(V _H = V _{T+} - V _{T-})				
		V _{CC} = 2.3 V to 2.7 V	0.10	-	0.60	V
		V _{CC} = 3.0 V to 3.6 V	0.15	-	0.56	V
V _{OH}	HIGH-level output voltage	V _I = V _{T+} or V _{T-}				
		I _O = -20 μA; V _{CC} = 2.3 V to 3.6 V	V _{CC} - 0.1	-	-	V
		I _O = -2.3 mA; V _{CC} = 2.3 V	1.97	-	-	V
		I _O = -3.1 mA; V _{CC} = 2.3 V	1.85	-	-	V
		I _O = -2.7 mA; V _{CC} = 3.0 V	2.67	-	-	V
		I _O = -4.0 mA; V _{CC} = 3.0 V	2.55	-	-	V
V _{OL}	LOW-level output voltage	V _I = V _{T+} or V _{T-}				
		I _O = 20 μA; V _{CC} = 2.3 V to 3.6 V	-	-	0.1	V
		I _O = 2.3 mA; V _{CC} = 2.3 V	-	-	0.33	V
		I _O = 3.1 mA; V _{CC} = 2.3 V	-	-	0.45	V
		I _O = 2.7 mA; V _{CC} = 3.0 V	-	-	0.33	V
		I _O = 4.0 mA; V _{CC} = 3.0 V	-	-	0.45	V
I _I	input leakage current	V _I = GND to 3.6 V; V _{CC} = 0 V to 3.6 V	-	-	±0.5	μA
I _{OFF}	power-off leakage current	V _I or V _O = 0 V to 3.6 V; V _{CC} = 0 V	-	-	±0.5	μA
ΔI _{OFF}	additional power-off leakage current	V _I or V _O = 0 V to 3.6 V; V _{CC} = 0 V to 0.2 V	-	-	±0.5	μA
I _{CC}	supply current	V _I = GND or V _{CC} ; I _O = 0 A; V _{CC} = 2.3 V to 3.6 V	-	-	1.5	μA
ΔI _{CC}	additional supply current	V _{CC} = 2.3 V to 2.7 V; I _O = 0 A [1]	-	-	4	μA
		V _{CC} = 3.0 V to 3.6 V; I _O = 0 A [2]	-	-	12	μA
T _{amb} = -40 °C to +125 °C						
V _{T+}	positive-going threshold voltage	V _{CC} = 2.3 V to 2.7 V	0.60	-	1.10	V
		V _{CC} = 3.0 V to 3.6 V	0.75	-	1.19	V
V _{T-}	negative-going threshold voltage	V _{CC} = 2.3 V to 2.7 V	0.33	-	0.64	V
		V _{CC} = 3.0 V to 3.6 V	0.46	-	0.85	V
V _H	hysteresis voltage	(V _H = V _{T+} - V _{T-})				
		V _{CC} = 2.3 V to 2.7 V	0.10	-	0.60	V
		V _{CC} = 3.0 V to 3.6 V	0.15	-	0.56	V
V _{OH}	HIGH-level output voltage	V _I = V _{T+} or V _{T-}				
		I _O = -20 μA; V _{CC} = 2.3 V to 3.6 V	V _{CC} - 0.11	-	-	V

Symbol	Parameter	Conditions	Min	Typ	Max	Unit
		$I_O = -2.3 \text{ mA}; V_{CC} = 2.3 \text{ V}$	1.77	-	-	V
		$I_O = -3.1 \text{ mA}; V_{CC} = 2.3 \text{ V}$	1.67	-	-	V
		$I_O = -2.7 \text{ mA}; V_{CC} = 3.0 \text{ V}$	2.40	-	-	V
		$I_O = -4.0 \text{ mA}; V_{CC} = 3.0 \text{ V}$	2.30	-	-	V
V_{OL}	LOW-level output voltage	$V_I = V_{T+}$ or V_{T-}				
		$I_O = 20 \text{ }\mu\text{A}; V_{CC} = 2.3 \text{ V to } 3.6 \text{ V}$	-	-	0.11	V
		$I_O = 2.3 \text{ mA}; V_{CC} = 2.3 \text{ V}$	-	-	0.36	V
		$I_O = 3.1 \text{ mA}; V_{CC} = 2.3 \text{ V}$	-	-	0.50	V
		$I_O = 2.7 \text{ mA}; V_{CC} = 3.0 \text{ V}$	-	-	0.36	V
		$I_O = 4.0 \text{ mA}; V_{CC} = 3.0 \text{ V}$	-	-	0.50	V
I_I	input leakage current	$V_I = \text{GND to } 3.6 \text{ V};$ $V_{CC} = 0 \text{ V to } 3.6 \text{ V}$	-	-	± 0.75	μA
I_{OFF}	power-off leakage current	V_I or $V_O = 0 \text{ V to } 3.6 \text{ V}; V_{CC} = 0 \text{ V}$	-	-	± 0.75	μA
ΔI_{OFF}	additional power-off leakage current	V_I or $V_O = 0 \text{ V to } 3.6 \text{ V};$ $V_{CC} = 0 \text{ V to } 0.2 \text{ V}$	-	-	± 0.75	μA
I_{CC}	supply current	$V_I = \text{GND or } V_{CC}; I_O = 0 \text{ A};$ $V_{CC} = 2.3 \text{ V to } 3.6 \text{ V}$	-	-	3.5	μA
ΔI_{CC}	additional supply current	$V_{CC} = 2.3 \text{ V to } 2.7 \text{ V}; I_O = 0 \text{ A}$ ^[1]	-	-	7	μA
		$V_{CC} = 3.0 \text{ V to } 3.6 \text{ V}; I_O = 0 \text{ A}$ ^[2]	-	-	22	μA

[1] One input at 0.3 V or 1.1 V, other input at V_{CC} or GND.

[2] One input at 0.45 V or 1.2 V, other input at V_{CC} or GND.

12 Dynamic characteristics

Table 10. Dynamic characteristics

Voltages are referenced to GND (ground = 0 V); for test circuit see [Figure 16](#).

Symbol	Parameter	Conditions	25 °C			-40 °C to +125 °C			Unit
			Min	Typ ^[1]	Max	Min	Max (85 °C)	Max (125 °C)	
$V_{CC} = 2.3 \text{ V to } 2.7 \text{ V}; V_I = 1.65 \text{ V to } 1.95 \text{ V}$									
t_{pd}	propagation delay	A, B, C to Y; see Figure 15 ^[2]							
		$C_L = 5 \text{ pF}$	2.2	3.5	5.5	0.5	6.8	7.5	ns
		$C_L = 10 \text{ pF}$	2.6	4.1	6.3	1.0	7.9	8.7	ns
		$C_L = 15 \text{ pF}$	2.9	4.6	6.9	1.0	8.7	9.6	ns
		$C_L = 30 \text{ pF}$	3.7	5.8	8.4	1.5	10.8	11.9	ns
$V_{CC} = 2.3 \text{ V to } 2.7 \text{ V}; V_I = 2.3 \text{ V to } 2.7 \text{ V}$									
t_{pd}	propagation delay	A, B, C to Y; see Figure 15 ^[2]							
		$C_L = 5 \text{ pF}$	1.8	3.4	5.5	0.5	6.0	6.6	ns
		$C_L = 10 \text{ pF}$	2.2	4.0	6.2	1.0	7.1	7.9	ns
		$C_L = 15 \text{ pF}$	2.5	4.4	6.8	1.0	7.9	8.7	ns
		$C_L = 30 \text{ pF}$	3.2	5.6	8.3	1.5	10.0	11.0	ns
$V_{CC} = 2.3 \text{ V to } 2.7 \text{ V}; V_I = 3.0 \text{ V to } 3.6 \text{ V}$									
t_{pd}	propagation delay	A, B, C to Y; see Figure 15 ^[2]							
		$C_L = 5 \text{ pF}$	1.4	3.1	5.0	0.5	5.5	6.1	ns
		$C_L = 10 \text{ pF}$	1.8	3.7	5.7	1.0	6.5	7.2	ns
		$C_L = 15 \text{ pF}$	2.2	4.2	6.3	1.0	7.4	8.2	ns
		$C_L = 30 \text{ pF}$	2.9	5.3	7.9	1.5	9.5	10.5	ns
$V_{CC} = 3.0 \text{ V to } 3.6 \text{ V}; V_I = 1.65 \text{ V to } 1.95 \text{ V}$									
t_{pd}	propagation delay	A, B, C to Y; see Figure 15 ^[2]							
		$C_L = 5 \text{ pF}$	2.1	2.9	3.9	0.5	8.0	8.8	ns
		$C_L = 10 \text{ pF}$	2.5	3.4	4.6	1.0	8.5	9.4	ns
		$C_L = 15 \text{ pF}$	2.9	3.9	5.2	1.0	9.1	10.1	ns
		$C_L = 30 \text{ pF}$	3.6	5.0	6.7	1.5	9.8	10.8	ns
$V_{CC} = 3.0 \text{ V to } 3.6 \text{ V}; V_I = 2.3 \text{ V to } 2.7 \text{ V}$									
t_{pd}	propagation delay	A, B, C to Y; see Figure 15 ^[2]							
		$C_L = 5 \text{ pF}$	1.7	2.8	4.2	0.5	5.3	5.9	ns
		$C_L = 10 \text{ pF}$	2.1	3.4	5.0	1.0	6.1	6.8	ns
		$C_L = 15 \text{ pF}$	2.4	3.8	5.6	1.0	6.8	7.5	ns
		$C_L = 30 \text{ pF}$	3.2	5.0	7.1	1.5	8.5	9.4	ns
$V_{CC} = 3.0 \text{ V to } 3.6 \text{ V}; V_I = 3.0 \text{ V to } 3.6 \text{ V}$									
t_{pd}	propagation delay	A, B, C to Y; see Figure 15 ^[2]							

Symbol	Parameter	Conditions	25 °C			-40 °C to +125 °C			Unit
			Min	Typ ^[1]	Max	Min	Max (85 °C)	Max (125 °C)	
		$C_L = 5 \text{ pF}$	1.4	2.7	4.2	0.5	4.7	5.2	ns
		$C_L = 10 \text{ pF}$	1.8	3.3	5.0	1.0	5.7	6.3	ns
		$C_L = 15 \text{ pF}$	2.1	3.8	5.6	1.0	6.2	6.9	ns
		$C_L = 30 \text{ pF}$	2.9	4.9	7.1	1.5	7.8	8.6	ns
$T_{\text{amb}} = 25 \text{ °C}$									
C_{PD}	power dissipation capacitance	$f_i = 1 \text{ MHz}; V_I = \text{GND to } V_{\text{CC}} \text{ [3]}$							
		$V_{\text{CC}} = 2.3 \text{ V to } 2.7 \text{ V}$	-	3.6	-	-	-	-	pF
		$V_{\text{CC}} = 3.0 \text{ V to } 3.6 \text{ V}$	-	4.3	-	-	-	-	pF

- [1] All typical values are measured at nominal V_{CC} .
- [2] t_{pd} is the same as t_{PLH} and t_{PHL} .
- [3] C_{PD} is used to determine the dynamic power dissipation (P_D in μW).
 $P_D = C_{\text{PD}} \times V_{\text{CC}}^2 \times f_i \times N + \sum(C_L \times V_{\text{CC}}^2 \times f_o)$ where:
 f_i = input frequency in MHz;
 f_o = output frequency in MHz;
 C_L = output load capacitance in pF;
 V_{CC} = supply voltage in V;
 N = number of inputs switching;
 $\sum(C_L \times V_{\text{CC}}^2 \times f_o)$ = sum of the outputs.

12.1 Waveforms and test circuit

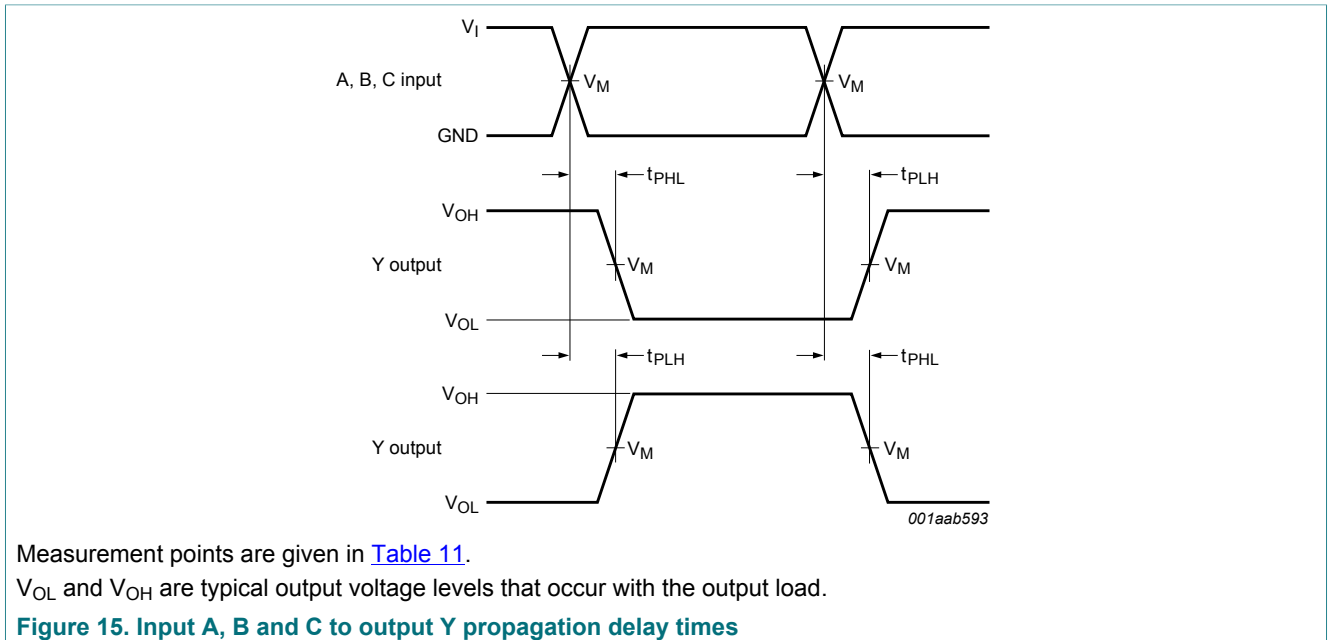
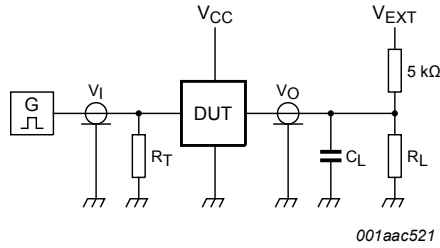

Table 11. Measurement points

Supply voltage	Output	Input		
V_{CC}	V_M	V_M	V_I	$t_r = t_f$
2.3 V to 3.6 V	$0.5V_{CC}$	$0.5V_I$	1.65 V to 3.6 V	≤ 3.0 ns



Test data is given in [Table 12](#).

Definitions test circuit:

R_T = termination resistance should be equal to output impedance Z_o of the pulse generator.

C_L = load capacitance including jig and probe capacitance.

R_L = load resistance.

Figure 16. Test circuit for measuring switching times

Table 12. Test data

Supply voltage	Load		V_{EXT}		
V_{CC}	C_L	$R_L^{[1]}$	t_{PLH}, t_{PHL}	t_{PZH}, t_{PHZ}	t_{PZL}, t_{PLZ}
2.3 V to 3.6 V	5 pF, 10 pF, 15 pF and 30 pF	5 kΩ or 1 MΩ	open	GND	$2 \times V_{CC}$

[1] For measuring enable and disable times $R_L = 5$ kΩ, for measuring propagation delays, setup and hold times and pulse width $R_L = 1$ MΩ.

13 Package outline

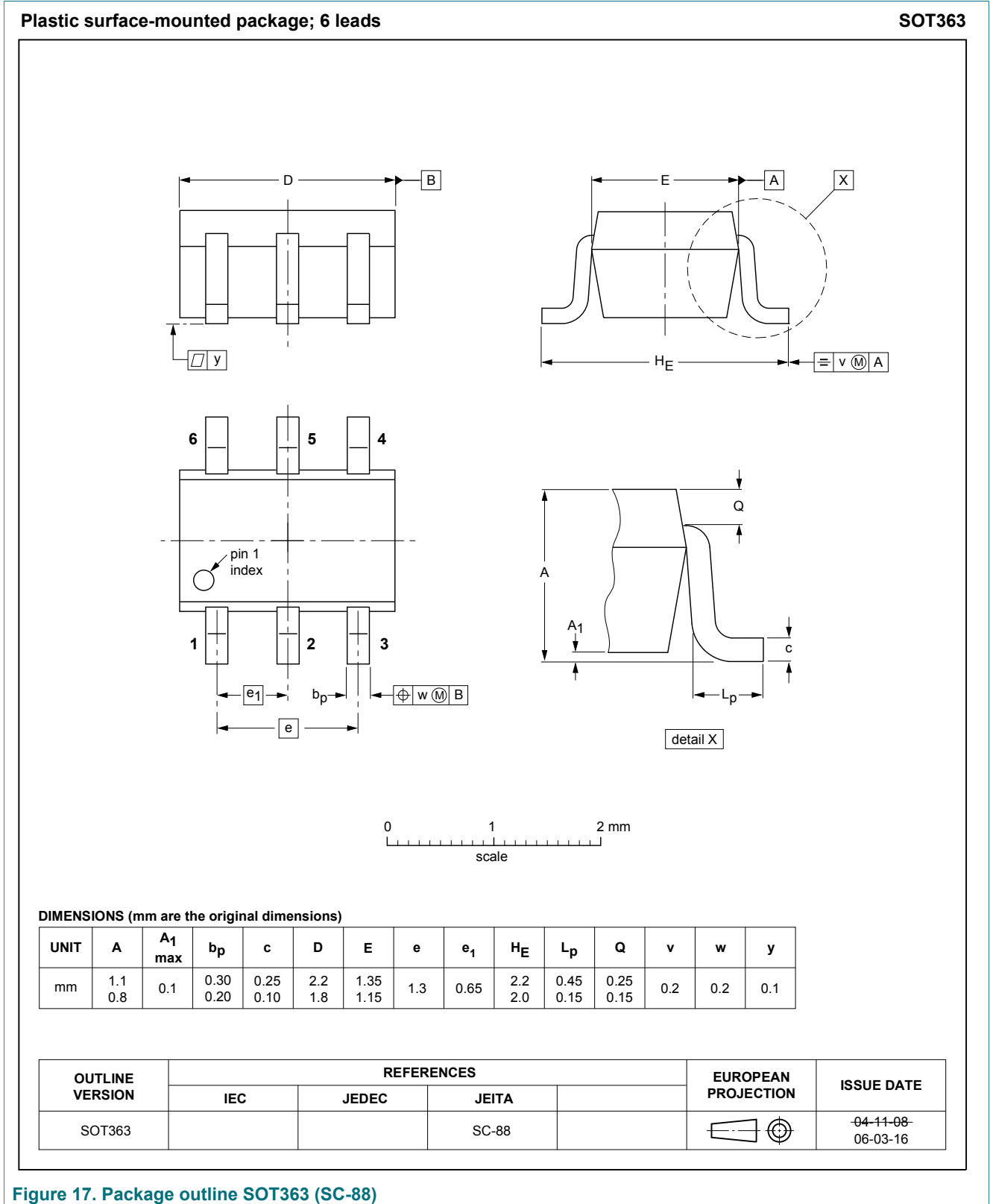
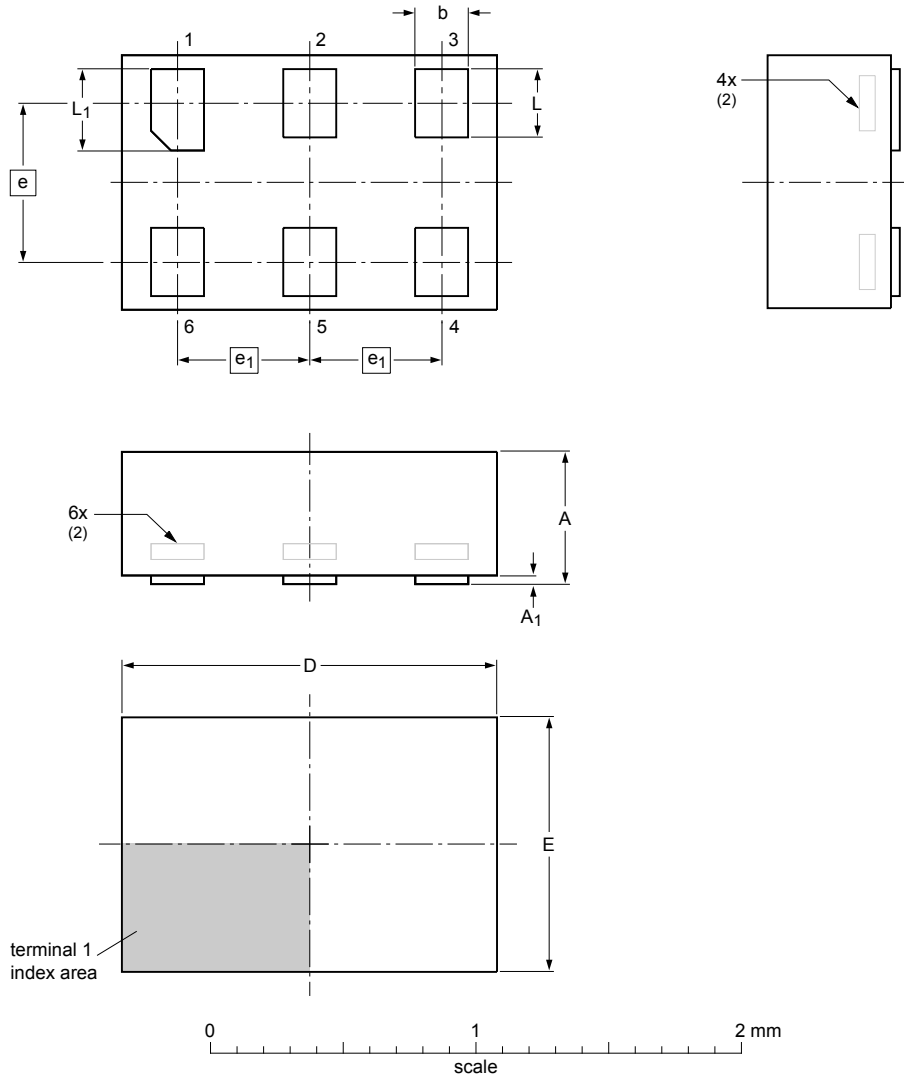

Figure 17. Package outline SOT363 (SC-88)

XSON6: plastic extremely thin small outline package; no leads; 6 terminals; body 1 x 1.45 x 0.5 mm

SOT886



Dimensions (mm are the original dimensions)

Unit	A ⁽¹⁾	A ₁	b	D	E	e	e ₁	L	L ₁
max	0.5	0.04	0.25	1.50	1.05			0.35	0.40
nom			0.20	1.45	1.00	0.6	0.5	0.30	0.35
min			0.17	1.40	0.95			0.27	0.32

Notes

- Including plating thickness.
- Can be visible in some manufacturing processes.

sot886_po

Outline version	References			European projection	Issue date
	IEC	JEDEC	JEITA		
SOT886		MO-252			04-07-22 12-01-05

Figure 18. Package outline SOT886 (XSON6)

XSON6: plastic extremely thin small outline package; no leads; 6 terminals; body 1 x 1 x 0.5 mm

SOT891

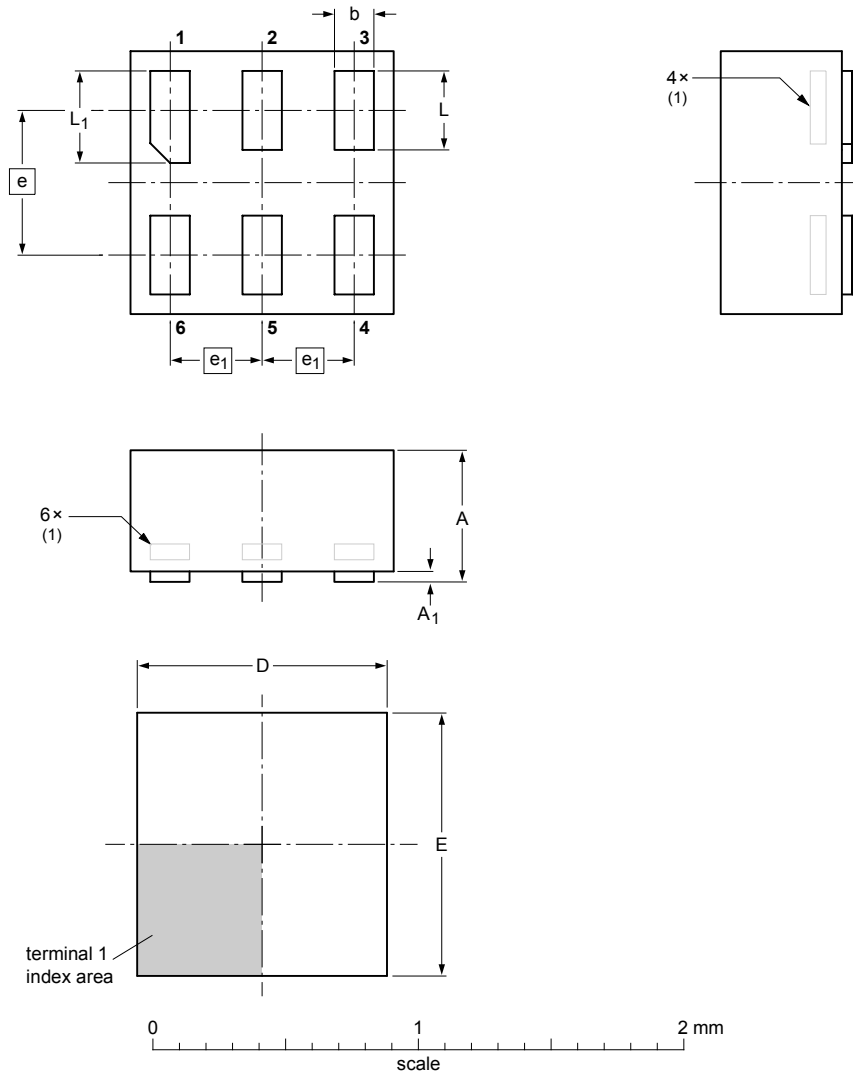

DIMENSIONS (mm are the original dimensions)

UNIT	A max	A ₁ max	b	D	E	e	e ₁	L	L ₁
mm	0.5	0.04	0.20 0.12	1.05 0.95	1.05 0.95	0.55	0.35	0.35 0.27	0.40 0.32

Note

1. Can be visible in some manufacturing processes.

OUTLINE VERSION	REFERENCES			EUROPEAN PROJECTION	ISSUE DATE
	IEC	JEDEC	JEITA		
SOT891					-05-04-06 07-05-15

Figure 19. Package outline SOT891 (XSON6)

**XSON6: extremely thin small outline package; no leads;
6 terminals; body 0.9 x 1.0 x 0.35 mm**

SOT1115

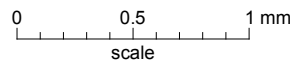

Dimensions

Unit	A ⁽¹⁾	A ₁	b	D	E	e	e ₁	L	L ₁
mm	max 0.35	0.04	0.20	0.95	1.05			0.35	0.40
	nom 0.15		0.90	1.00	0.55	0.3		0.30	0.35
	min 0.12		0.85	0.95				0.27	0.32

Note

- Including plating thickness.
- Visible depending upon used manufacturing technology.

sot1115_po

Outline version	References				European projection	Issue date
	IEC	JEDEC	JEITA			
SOT1115						-10-04-02- 10-04-07

Figure 20. Package outline SOT1115 (XSON6)

XSON6: extremely thin small outline package; no leads;
6 terminals; body 1.0 x 1.0 x 0.35 mm

SOT1202

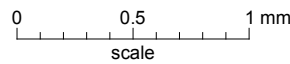

Dimensions

Unit	A ⁽¹⁾	A ₁	b	D	E	e	e ₁	L	L ₁
mm	max 0.35	0.04	0.20	1.05	1.05	0.35	0.30	0.35	0.40
	nom 0.15	1.00	1.00	0.55	0.35	0.30	0.35		
	min 0.12	0.95	0.95			0.27	0.32		

Note

- Including plating thickness.
- Visible depending upon used manufacturing technology.

sot1202_po

Outline version	References				European projection	Issue date
	IEC	JEDEC	JEITA			
SOT1202						-10-04-02- 10-04-06

Figure 21. Package outline SOT1202 (XSON6)

X2SON6: plastic thermal enhanced extremely thin small outline package; no leads;
6 terminals; body 1.0 x 0.8 x 0.35 mm

SOT1255

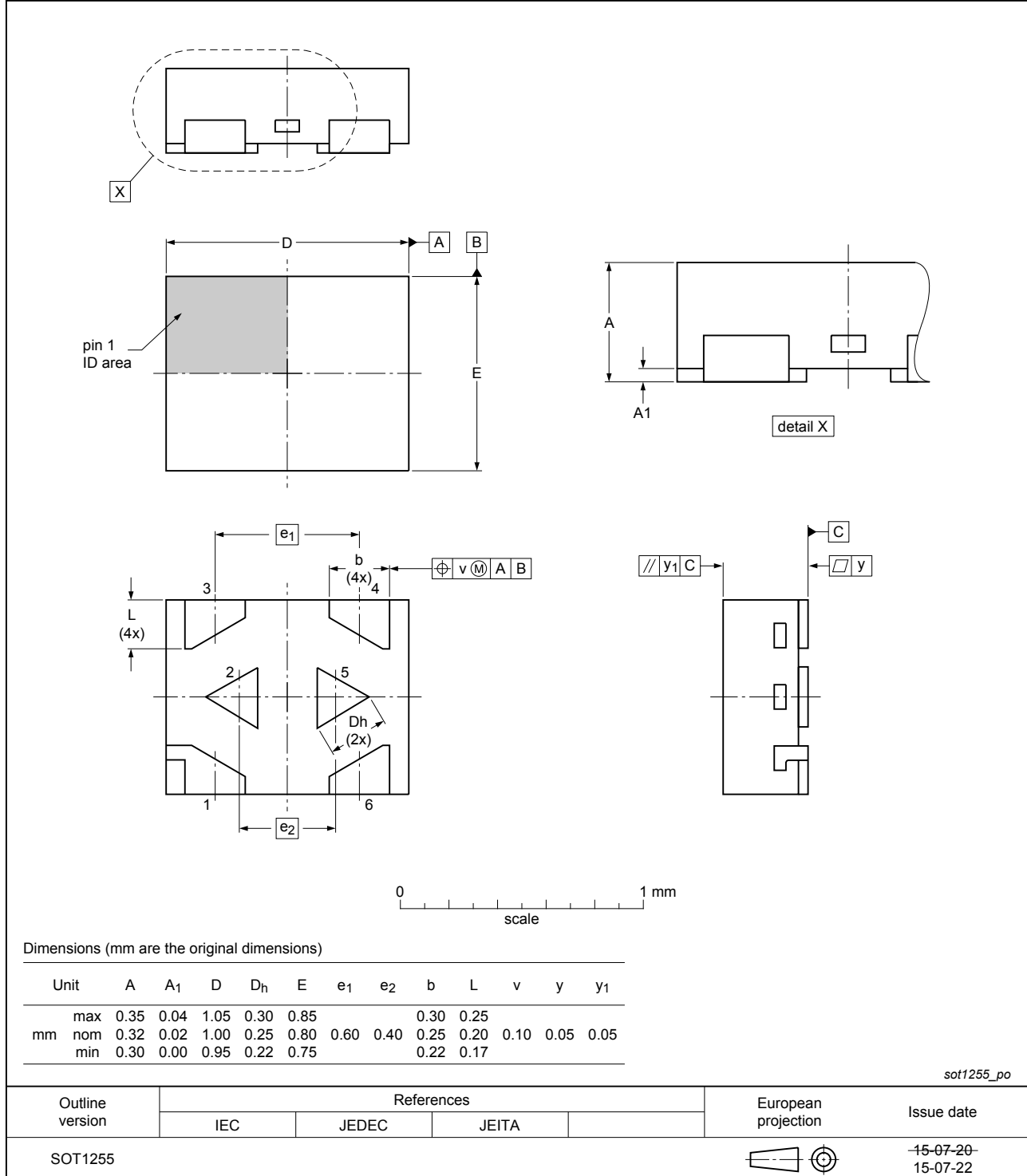

Figure 22. Package outline SOT1255 (X2SON6)

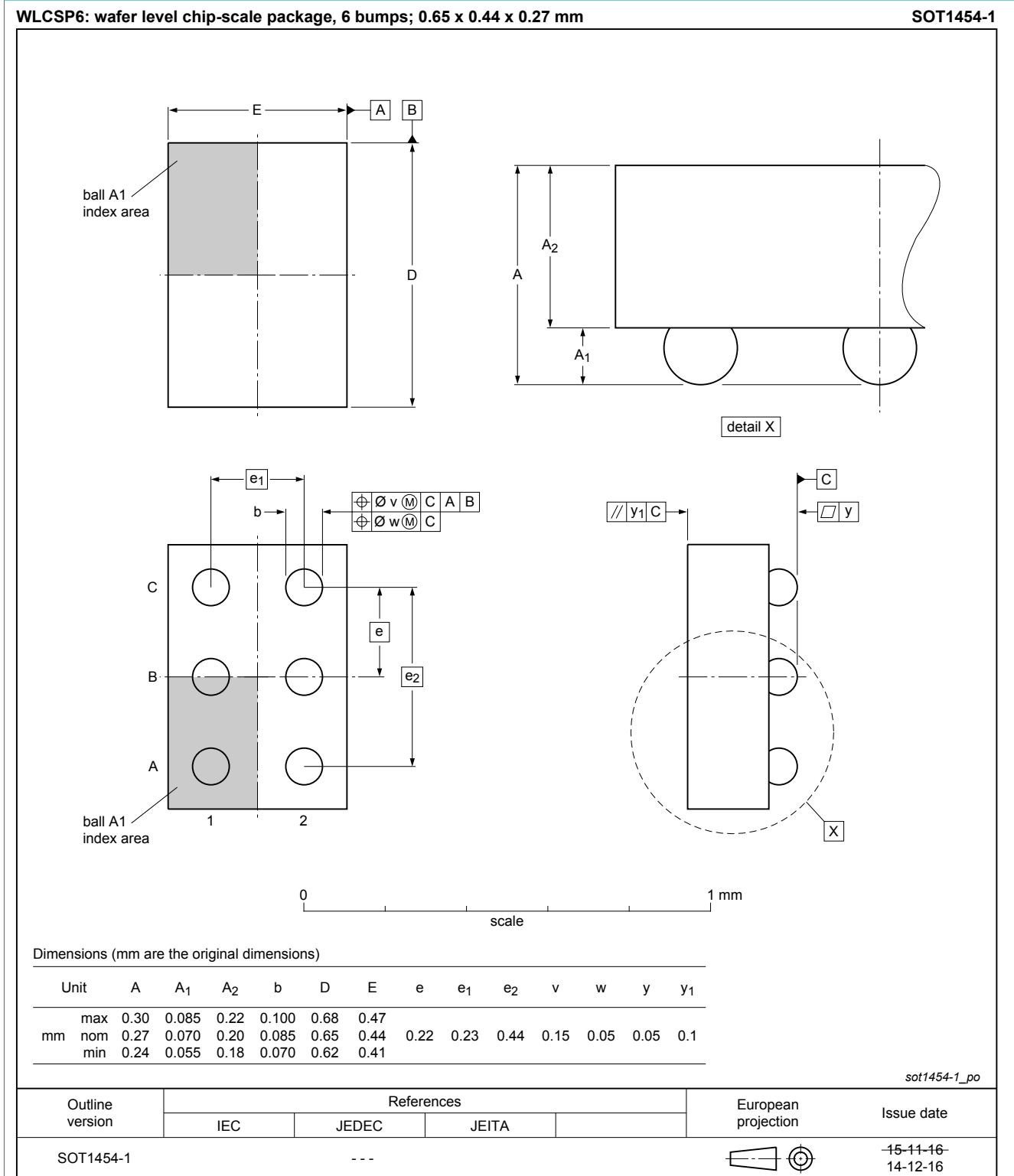

Figure 23. Package outline SOT1454-1 (WLCSP6)

14 Abbreviations

Table 13. Abbreviations

Acronym	Description
CDM	Charged Device Model
CMOS	Complementary Metal Oxide Semiconductor
DUT	Device Under Test
ESD	ElectroStatic Discharge
HBM	Human Body Model
MM	Machine Model

15 Revision history

Table 14. Revision history

Document ID	Release date	Data sheet status	Change notice	Supersedes
74AUP1T97 v.6	20170328	Product data sheet	-	74AUP1T97 v.5
Modifications:	<ul style="list-style-type: none"> Added type number 74AUP1T97UK (WLCSP6). 			
74AUP1T97 v.5	20150917	Product data sheet	-	74AUP1T97 v.4
Modifications:	<ul style="list-style-type: none"> Added type number 74AUP1T97GX (SOT1255/X2SON6). 			
74AUP1T97 v.4	20120815	Product data sheet	-	74AUP1T97 v.3
Modifications:	<ul style="list-style-type: none"> Package outline drawing of SOT886 (Figure 18) modified. 			
74AUP1T97 v.3	20111130	Product data sheet	-	74AUP1T97 v.2
74AUP1T97 v.2	20101018	Product data sheet	-	74AUP1T97 v.1
74AUP1T97 v.1	20071025	Product data sheet	-	-

16 Legal information

16.1 Data sheet status

Document status ^{[1][2]}	Product status ^[3]	Definition
Objective [short] data sheet	Development	This document contains data from the objective specification for product development.
Preliminary [short] data sheet	Qualification	This document contains data from the preliminary specification.
Product [short] data sheet	Production	This document contains the product specification.

[1] Please consult the most recently issued document before initiating or completing a design.

[2] The term 'short data sheet' is explained in section "Definitions".

[3] The product status of device(s) described in this document may have changed since this document was published and may differ in case of multiple devices. The latest product status information is available on the Internet at URL <http://www.nexperia.com>.

16.2 Definitions

Draft — The document is a draft version only. The content is still under internal review and subject to formal approval, which may result in modifications or additions. Nexperia does not give any representations or warranties as to the accuracy or completeness of information included herein and shall have no liability for the consequences of use of such information.

Short data sheet — A short data sheet is an extract from a full data sheet with the same product type number(s) and title. A short data sheet is intended for quick reference only and should not be relied upon to contain detailed and full information. For detailed and full information see the relevant full data sheet, which is available on request via the local Nexperia sales office. In case of any inconsistency or conflict with the short data sheet, the full data sheet shall prevail.

Product specification — The information and data provided in a Product data sheet shall define the specification of the product as agreed between Nexperia and its customer, unless Nexperia and customer have explicitly agreed otherwise in writing. In no event however, shall an agreement be valid in which the Nexperia product is deemed to offer functions and qualities beyond those described in the Product data sheet.

16.3 Disclaimers

Limited warranty and liability — Information in this document is believed to be accurate and reliable. However, Nexperia does not give any representations or warranties, expressed or implied, as to the accuracy or completeness of such information and shall have no liability for the consequences of use of such information. Nexperia takes no responsibility for the content in this document if provided by an information source outside of Nexperia. In no event shall Nexperia be liable for any indirect, incidental, punitive, special or consequential damages (including - without limitation - lost profits, lost savings, business interruption, costs related to the removal or replacement of any products or rework charges) whether or not such damages are based on tort (including negligence), warranty, breach of contract or any other legal theory. Notwithstanding any damages that customer might incur for any reason whatsoever, Nexperia's aggregate and cumulative liability towards customer for the products described herein shall be limited in accordance with the Terms and conditions of commercial sale of Nexperia.

Right to make changes — Nexperia reserves the right to make changes to information published in this document, including without limitation specifications and product descriptions, at any time and without notice. This document supersedes and replaces all information supplied prior to the publication hereof.

Suitability for use — Nexperia products are not designed, authorized or warranted to be suitable for use in life support, life-critical or safety-critical

systems or equipment, nor in applications where failure or malfunction of an Nexperia product can reasonably be expected to result in personal injury, death or severe property or environmental damage. Nexperia and its suppliers accept no liability for inclusion and/or use of Nexperia products in such equipment or applications and therefore such inclusion and/or use is at the customer's own risk.

Applications — Applications that are described herein for any of these products are for illustrative purposes only. Nexperia makes no representation or warranty that such applications will be suitable for the specified use without further testing or modification. Customers are responsible for the design and operation of their applications and products using Nexperia products, and Nexperia accepts no liability for any assistance with applications or customer product design. It is customer's sole responsibility to determine whether the Nexperia product is suitable and fit for the customer's applications and products planned, as well as for the planned application and use of customer's third party customer(s). Customers should provide appropriate design and operating safeguards to minimize the risks associated with their applications and products. Nexperia does not accept any liability related to any default, damage, costs or problem which is based on any weakness or default in the customer's applications or products, or the application or use by customer's third party customer(s). Customer is responsible for doing all necessary testing for the customer's applications and products using Nexperia products in order to avoid a default of the applications and the products or of the application or use by customer's third party customer(s). Nexperia does not accept any liability in this respect.

Limiting values — Stress above one or more limiting values (as defined in the Absolute Maximum Ratings System of IEC 60134) will cause permanent damage to the device. Limiting values are stress ratings only and (proper) operation of the device at these or any other conditions above those given in the Recommended operating conditions section (if present) or the Characteristics sections of this document is not warranted. Constant or repeated exposure to limiting values will permanently and irreversibly affect the quality and reliability of the device.

Terms and conditions of commercial sale — Nexperia products are sold subject to the general terms and conditions of commercial sale, as published at <http://www.nexperia.com/profile/terms>, unless otherwise agreed in a valid written individual agreement. In case an individual agreement is concluded only the terms and conditions of the respective agreement shall apply. Nexperia hereby expressly objects to applying the customer's general terms and conditions with regard to the purchase of Nexperia products by customer.

No offer to sell or license — Nothing in this document may be interpreted or construed as an offer to sell products that is open for acceptance or the grant, conveyance or implication of any license under any copyrights, patents or other industrial or intellectual property rights.

Export control — This document as well as the item(s) described herein may be subject to export control regulations. Export might require a prior authorization from competent authorities.

Non-automotive qualified products — Unless this data sheet expressly states that this specific Nexperia product is automotive qualified, the product is not suitable for automotive use. It is neither qualified nor tested in accordance with automotive testing or application requirements. Nexperia accepts no liability for inclusion and/or use of non-automotive qualified products in automotive equipment or applications. In the event that customer uses the product for design-in and use in automotive applications to automotive specifications and standards, customer (a) shall use the product without Nexperia's warranty of the product for such automotive applications, use and specifications, and (b) whenever customer uses the product for automotive applications beyond Nexperia's specifications such use shall be solely at customer's own risk, and (c) customer fully indemnifies Nexperia for any liability, damages or failed product claims resulting from customer

design and use of the product for automotive applications beyond Nexperia's standard warranty and Nexperia's product specifications.

Translations — A non-English (translated) version of a document is for reference only. The English version shall prevail in case of any discrepancy between the translated and English versions.

16.4 Trademarks

Notice: All referenced brands, product names, service names and trademarks are the property of their respective owners.

Contents

1	General description	1
2	Features and benefits	1
3	Ordering information	2
4	Marking	2
5	Pinning information	3
5.1	Pinning	3
5.2	Pin description	4
6	Functional description	4
7	Functional diagram	4
8	Logic configurations	5
9	Limiting values	6
10	Recommended operating conditions	6
11	Static characteristics	7
12	Dynamic characteristics	10
12.1	Waveforms and test circuit	11
13	Package outline	13
14	Abbreviations	20
15	Revision history	20
16	Legal information	21

Please be aware that important notices concerning this document and the product(s) described herein, have been included in section 'Legal information'.

© Nexperia B.V. 2017.

All rights reserved.

For more information, please visit: <http://www.nexperia.com>

For sales office addresses, please send an email to: salesaddresses@nexperia.com

Date of release: 28 March 2017
Document identifier: 74AUP1T97



Компания «ЭлектроПласт» предлагает заключение долгосрочных отношений при поставках импортных электронных компонентов на взаимовыгодных условиях!

Наши преимущества:

- Оперативные поставки широкого спектра электронных компонентов отечественного и импортного производства напрямую от производителей и с крупнейших мировых складов;
- Поставка более 17-ти миллионов наименований электронных компонентов;
- Поставка сложных, дефицитных, либо снятых с производства позиций;
- Оперативные сроки поставки под заказ (от 5 рабочих дней);
- Экспресс доставка в любую точку России;
- Техническая поддержка проекта, помощь в подборе аналогов, поставка прототипов;
- Система менеджмента качества сертифицирована по Международному стандарту ISO 9001;
- Лицензия ФСБ на осуществление работ с использованием сведений, составляющих государственную тайну;
- Поставка специализированных компонентов (Xilinx, Altera, Analog Devices, Intersil, Interpoint, Microsemi, Aeroflex, Peregrine, Syfer, Eurofarad, Texas Instrument, Miteq, Cobham, E2V, MA-COM, Hittite, Mini-Circuits, General Dynamics и др.);

Помимо этого, одним из направлений компании «ЭлектроПласт» является направление «Источники питания». Мы предлагаем Вам помощь Конструкторского отдела:

- Подбор оптимального решения, техническое обоснование при выборе компонента;
- Подбор аналогов;
- Консультации по применению компонента;
- Поставка образцов и прототипов;
- Техническая поддержка проекта;
- Защита от снятия компонента с производства.



Как с нами связаться

Телефон: 8 (812) 309 58 32 (многоканальный)

Факс: 8 (812) 320-02-42

Электронная почта: org@eplast1.ru

Адрес: 198099, г. Санкт-Петербург, ул. Калинина, дом 2, корпус 4, литера А.