

## DUAL OPERATIONAL AMPLIFIER

### ■ GENERAL DESCRIPTION

The NJM14558 is dual operational amplifier, which can operate from  $\pm 2V$  supply. The features are low offset voltage, low bias current and low current consumption.

The package lineup is DIP, DMP and others, so that the NJM14558 is suitable for portable audio and any kind of signal amplifier.

### ■ FEATURES

- Operating Voltage (  $\pm 2.0V \sim \pm 7.0V$  )
- Input Offset Voltage ( 3mV max. )
- Slew Rate ( 2.5V/ $\mu s$  typ. )
- Bipolar Technology
- Package Outline DIP8, DMP8, EMP8, SSOP8, VSP8, SIP8

### ■ PACKAGE OUTLINE

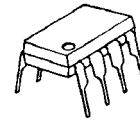

NJM14558D



NJM14558M



NJM14558E



NJM14558V



NJM14558R

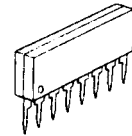

NJM14558L

### ■ PIN CONFIGURATION

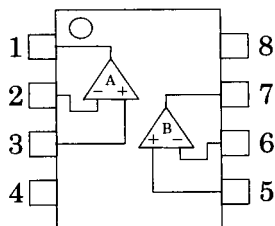

NJM14558/14558M/14558E  
NJM14558V/14558R

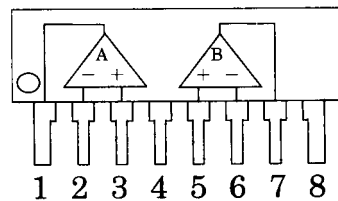

NJM14558L

### PIN FUNCTION

1. A OUTPUT
2. A -INPUT
3. A +INPUT
4. V<sup>-</sup>
5. B +INPUT
6. B -INPUT
7. B OUTPUT
8. V<sup>+</sup>

### ■ EQUIVALENT CIRCUIT ( 1/2 Shown )

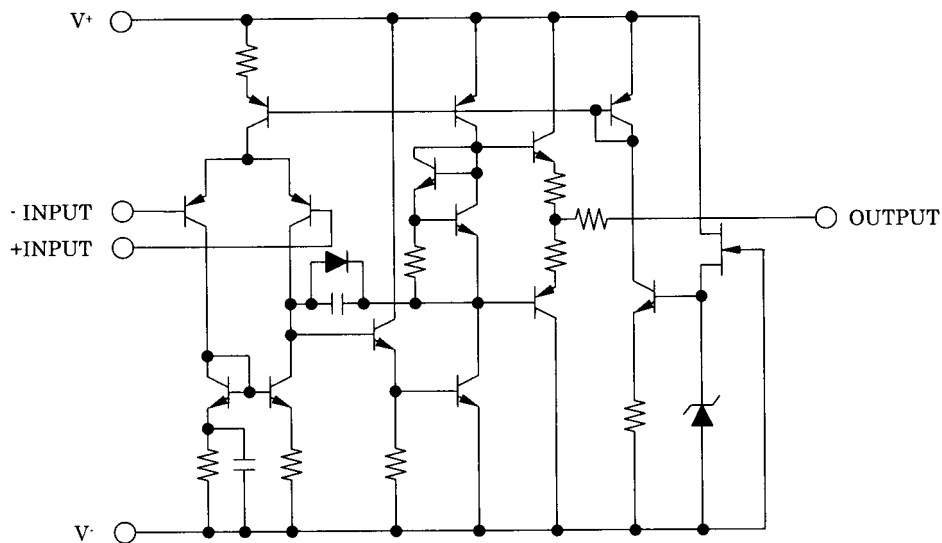

# NJM14558

## ■ ABSOLUTE MAXIMUM RATINGS

( Ta=25°C )

PARAMETER	SYMBOL	RATINGS	UNIT
Supply Voltage	V <sup>+</sup> /V <sup>-</sup>	± 7.5	V
Differential Input Voltage	V <sub>ID</sub>	± 14	V
Input Voltage	V <sub>IC</sub>	± 7 ( note )	V
Power Dissipation	P <sub>D</sub>	( DIP8 ) 500 ( DMP8 ) 300 ( EMP8 ) 300 ( SSOP8 ) 250 ( VSP8 ) 320 ( SIP8 ) 800	mW
Operating Temperature Range	T <sub>opr</sub>	-40~+85	°C
Storage Temperature Range	T <sub>stg</sub>	-40~+125	°C

( note ) For supply voltage less than ±7V, the absolute maximum input voltage is equal to the supply voltage.

## ■ ELECTRICAL CHARACTERISTICS

( V<sup>+</sup>/V<sup>-</sup>=±5V, Ta=25°C )

PARAMETER	SYMBOL	TEST CONDITION	MIN.	TYP.	MAX.	UNIT
Operating Voltage	V <sub>opr</sub>		± 2	-	± 7	V
Input Offset Voltage	V <sub>IO</sub>	R <sub>S</sub> ≤10kΩ	-	0.5	3	mV
Input Offset Current	I <sub>IO</sub>		-	5	50	nA
Input Bias Current	I <sub>B</sub>		-	70	250	nA
Input Resistance	R <sub>IN</sub>		0.3	5	-	MΩ
Large Signal Voltage Gain	A <sub>V</sub>	R <sub>L</sub> ≥2kΩ, V <sub>O</sub> =±3V	86	100	-	dB
Maximum Output Voltage Swing ( + )	V <sub>OM</sub> <sup>+</sup>	R <sub>L</sub> ≥2kΩ	3.5	4.0	-	V
Maximum Output Voltage Swing ( - )	V <sub>OM</sub> <sup>-</sup>	R <sub>L</sub> ≥2kΩ	-	-3.5	-3.0	V
Input Common Mode Voltage Range	V <sub>ICM</sub>		± 3.0	± 4.0	-	V
Common Mode Rejection Ratio	CMR	R <sub>S</sub> ≤10kΩ	70	90	-	dB
Supply Voltage Rejection Ratio	SVR	R <sub>S</sub> ≤10kΩ	76.5	90	-	dB
Operating Current	I <sub>CC</sub>		-	2.7	4.5	mA
Slew Rate	SR		-	2.5	-	V/μs
Equivalent Input Noise Voltage	V <sub>Ni</sub>	RIAA, R <sub>S</sub> =2.2kΩ, 30kHz:LPF	-	1.4	-	μVrms
Gain Bandwidth Product	GB		-	5	-	MHz

## ■ TYPICAL CHARACTERISTICS

NJM14558 Operating Current vs. Operating Voltage

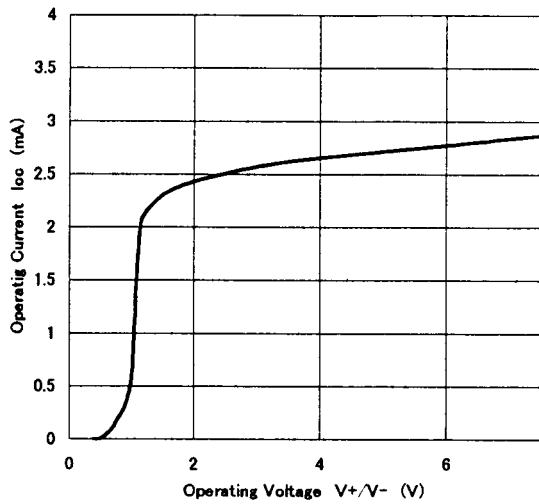

NJM14558 Input Offset Voltage vs. Operating Voltage

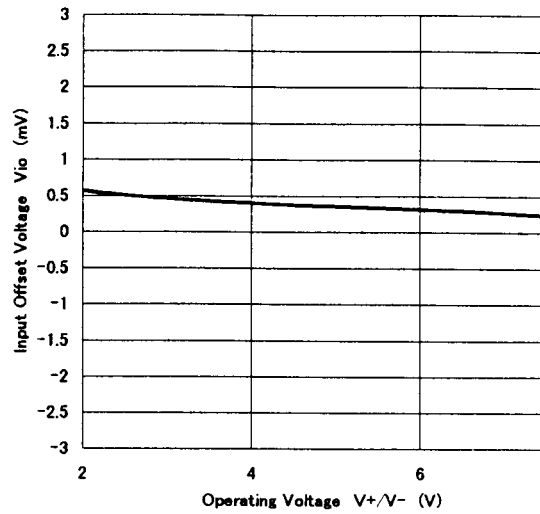

NJM14558 Input Bias Current vs. Operating Voltage

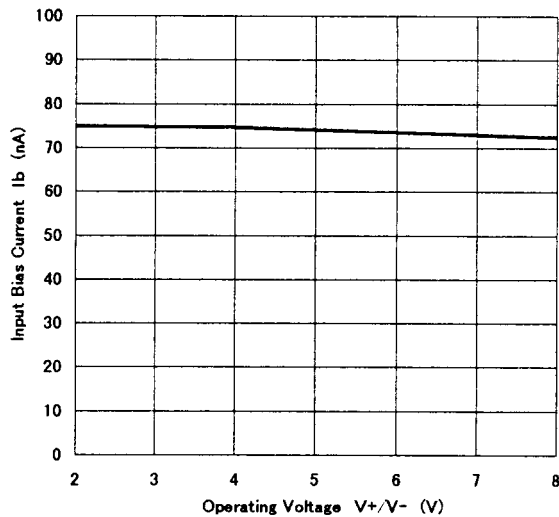

NJM14558 Maximum Output Voltage Swing vs. Operating Voltage

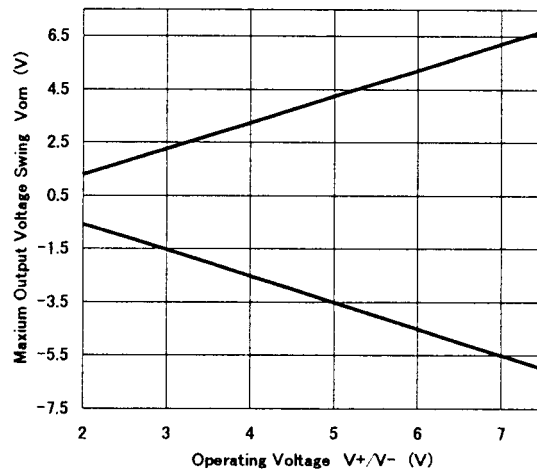

NJM14558 Input Common Mode Voltage Range

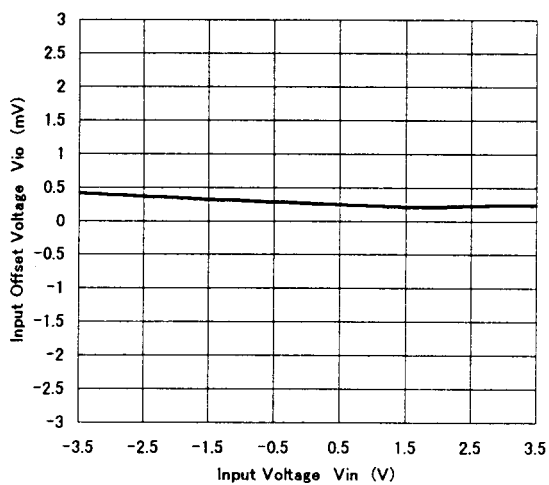

# NJM14558

## ■ TYPICAL CHARACTERISTICS

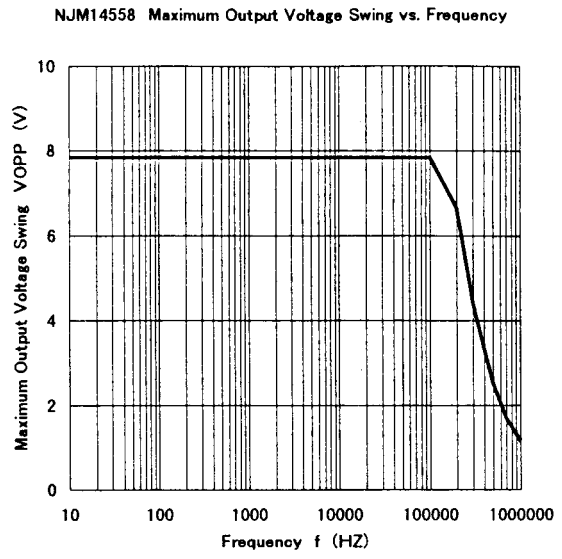
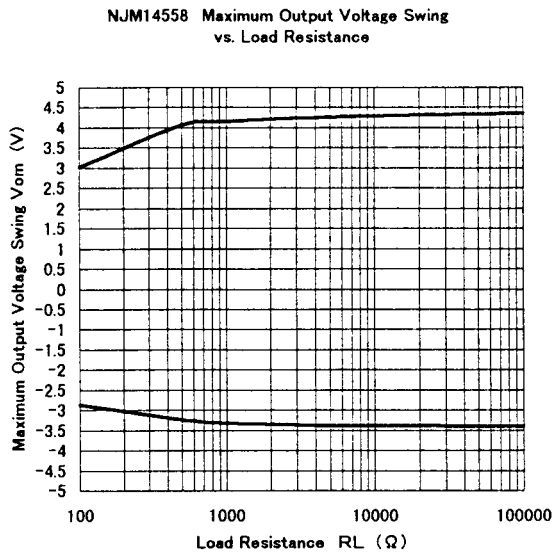

## ■ TYPICAL CHARACTERISTICS

NJM14558 Large Signal Voltage Gain vs. Operating Voltage

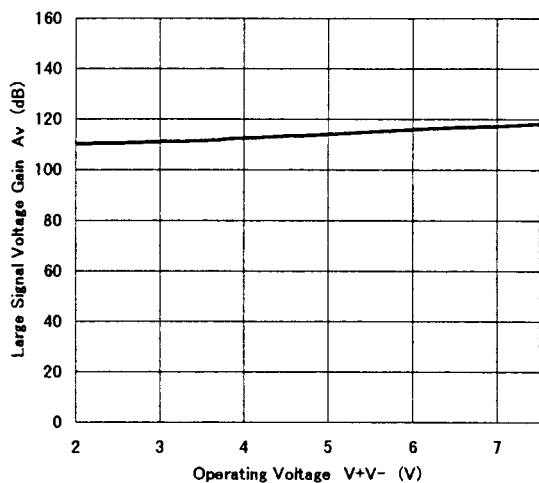

NJM14558 Large Signal Voltage Gain vs. Frequency

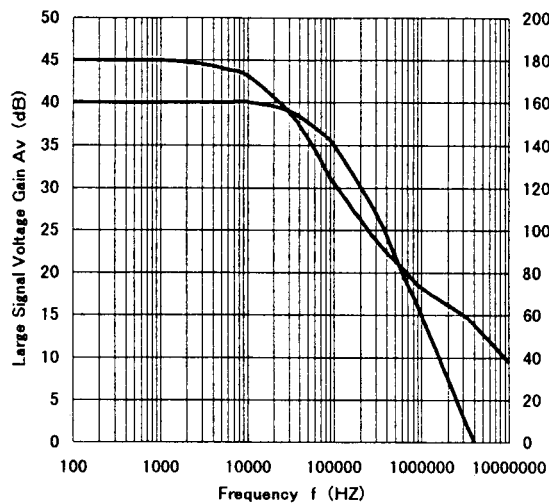

NJM14558 Slew Rate(Fall)

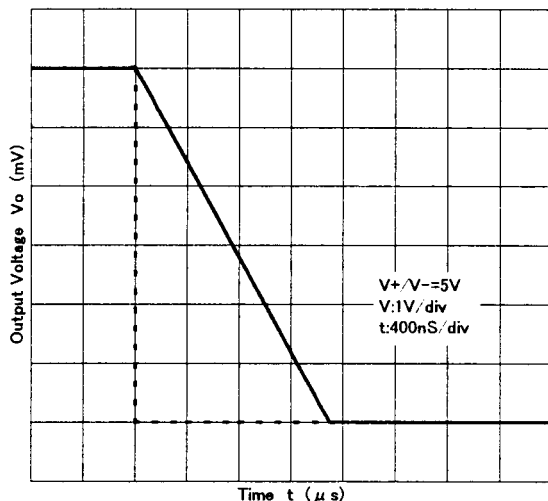

NJM14558 Slew Rate(Rise)

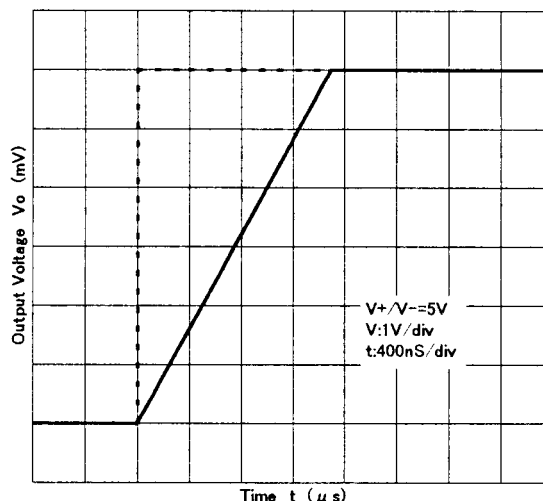

NJM14558 THD vs. Output Voltage

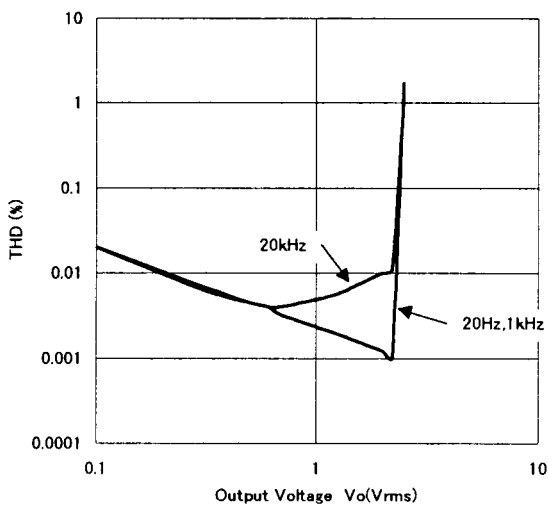

NJM14558 Equivalent Input Noise Voltage vs. Frequency

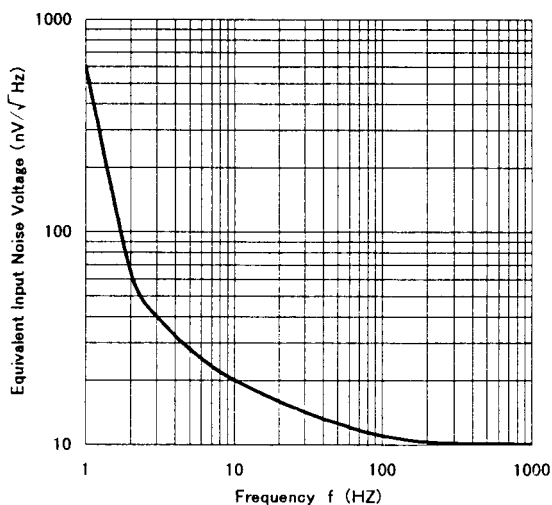

## ■ TYPICAL CHARACTERISTICS

NJM14558 Operating Current vs. Temperature

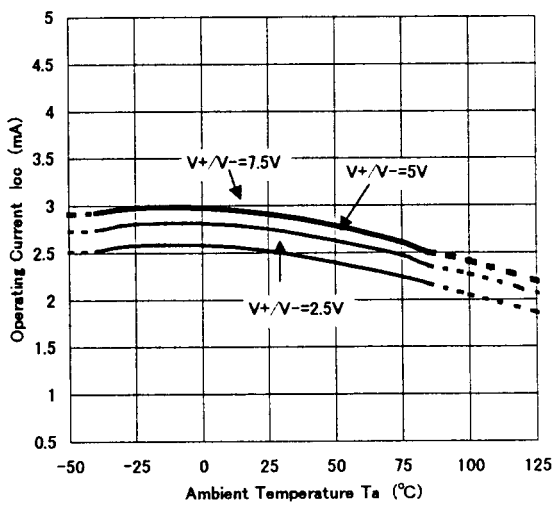

NJM14558 Input Offset Voltage vs. Temperature

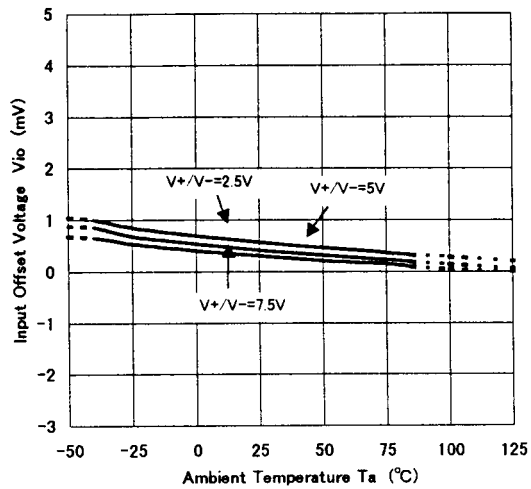

NJM14558 Input Bias Current vs. Temperature

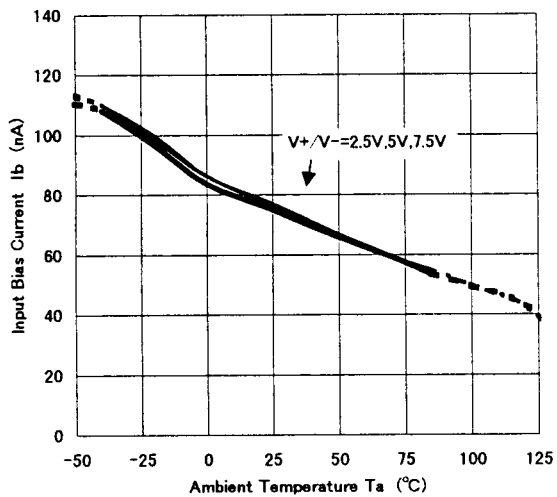

NJM14558 Maximum Output Voltage Swing vs. Temperature

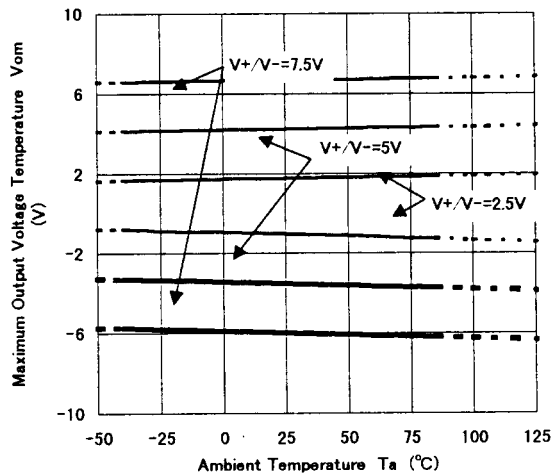

## ■ TYPICAL CHARACTERISTICS

NJM14558 Large Signal Voltage Gain vs. Temperature

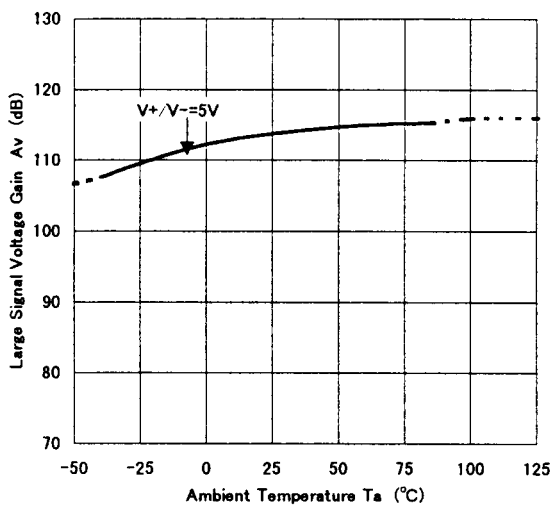

NJM14558 Common Mode Rejection Ratio vs. Temperature

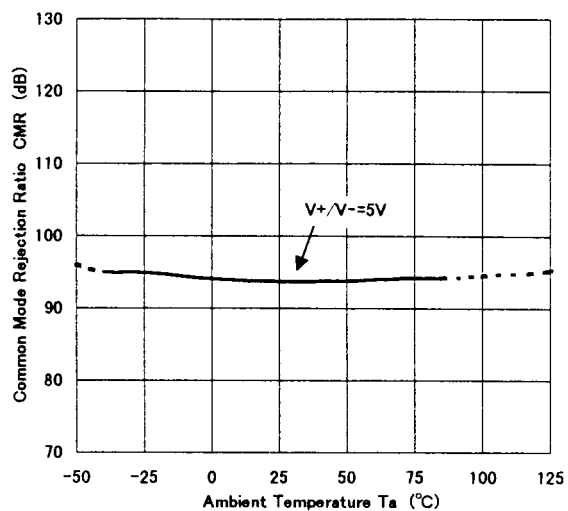

NJM14558 Supply Voltage Rejection Ratio vs. Temperature

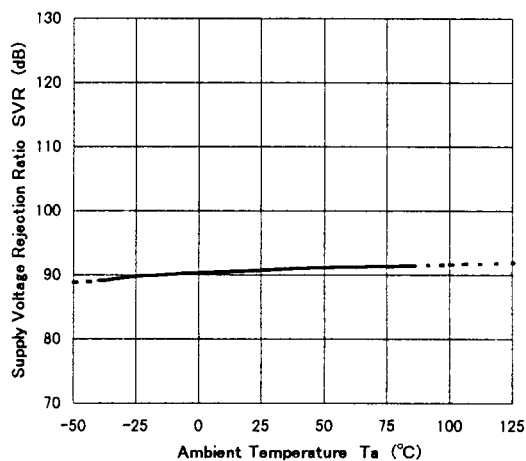

**[CAUTION]**

The specifications on this databook are only given for information, without any guarantee as regards either mistakes or omissions. The application circuits in this databook are described only to show representative usages of the product and not intended for the guarantee or permission of any right including the industrial rights.



Компания «ЭлектроПласт» предлагает заключение долгосрочных отношений при поставках импортных электронных компонентов на взаимовыгодных условиях!

Наши преимущества:

- Оперативные поставки широкого спектра электронных компонентов отечественного и импортного производства напрямую от производителей и с крупнейших мировых складов;
- Поставка более 17-ти миллионов наименований электронных компонентов;
- Поставка сложных, дефицитных, либо снятых с производства позиций;
- Оперативные сроки поставки под заказ (от 5 рабочих дней);
- Экспресс доставка в любую точку России;
- Техническая поддержка проекта, помощь в подборе аналогов, поставка прототипов;
- Система менеджмента качества сертифицирована по Международному стандарту ISO 9001;
- Лицензия ФСБ на осуществление работ с использованием сведений, составляющих государственную тайну;
- Поставка специализированных компонентов (Xilinx, Altera, Analog Devices, Intersil, Interpoint, Microsemi, Aeroflex, Peregrine, Syfer, Eurofarad, Texas Instrument, Miteq, Cobham, E2V, MA-COM, Hittite, Mini-Circuits, General Dynamics и др.);

Помимо этого, одним из направлений компании «ЭлектроПласт» является направление «Источники питания». Мы предлагаем Вам помощь Конструкторского отдела:

- Подбор оптимального решения, техническое обоснование при выборе компонента;
- Подбор аналогов;
- Консультации по применению компонента;
- Поставка образцов и прототипов;
- Техническая поддержка проекта;
- Защита от снятия компонента с производства.



#### Как с нами связаться

**Телефон:** 8 (812) 309 58 32 (многоканальный)

**Факс:** 8 (812) 320-02-42

**Электронная почта:** [org@eplast1.ru](mailto:org@eplast1.ru)

**Адрес:** 198099, г. Санкт-Петербург, ул. Калинина, дом 2, корпус 4, литера А.