

NEW

OMRON

Smart Sensors ZS Series

2D CMOS Laser Type



High-precision Displacement Measurement Sensors Bringing Smart Sensors into New Fields.



realizing

ZS-HL Series

More P.6

Very High-performance Sensors that Support Core Quality from Very Long-range to Extremely Precise Measurements

- Range of models with measuring center distance of 20 to 1,500 mm.
- Achieves maximum resolution of 0.02 μm (0.001 μm).
- Maximum response speed of 110 μs .
- Parallel output supported.



See

Highly Advanced Sensing Function



Record

Data Storage Unit ZS-DSU ZS-DSU
Ideal for ZS Series Data Logging

Enables onsite high-speed logging of data in external memory (compact flash card) for the Sensor Controller or Multi-Controller.

Effective for building traceability systems, statistical process control (SPC), and much more.

High-speed sampling rate: 150 μs
Powerful support for logging data using various trigger functions.

More P.18

Control

Multi-Controller ZS-MDC
Enables full application of Sensor Controller information.

Transfers data between multi-connected Sensor Controllers and performs high-speed multiprocessing.

Connects to up to nine Sensor Controllers.

More P.17

Functions in a Compact Package



Manipulate

Sensor Controllers ZS-HLDC/LDC
Enable maximum sensing performance with fully digital processing.

Culmination of OMRON's lead-edge digital technology. Enables easy utilization of the ultimate in measurement performance.

- Business card size
- USB provided as a standard feature.

More P.12

Monitor

SmartMonitor Professional ZS-SW11E V3
Setting Software for the ZS Series

Meets a wide range of logging needs. Supports high-speed simultaneous multichannel waveform graphs. Excel macros provided for simple analysis.

More P.19

ZS-L Series

More P.14

Standard Sensors Most Suitable for a Variety of High-precision Displacement Measurements, Including Spot Detection, Wide-range Detection, and Long-distance Detection.

- Beam Shapes
Spot and line beam selection.
- Wide Range of Products
Long-range, middle-range, and short-range models.

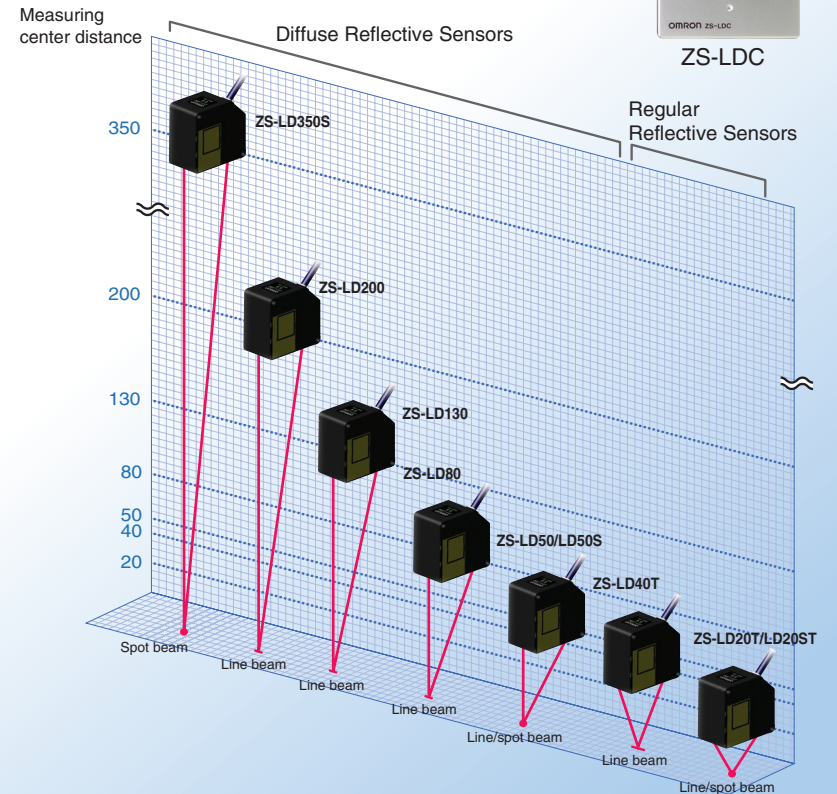

Main Applications

High Performance Very High-performance Sensors that Support Core Quality from Very Long-range to Extremely Precise Measurements

ZS-HL Series



ZS-LD10GT/LD15GT



Ideal for measuring and controlling dispenser nozzle gaps when applying sealer.

ZS-HLDS2T



Ideal for measuring the thickness of silicon or compound semiconductor wafers in polishing and testing processes.

ZS-HLDS2VT



Ideal for measuring the potting resin height for electronic components.

ZS-HLDS5T



Ideal for measuring liquid gasket (FPIG) application amounts. Prevents defects such as insufficient seal.

ZS-HLDS10



Ideal for confirming positioning and repeatability accuracy of XY stages.

ZS-HLDS60



Ideal for level detection for liquid crystal coaters and PDP fluorescent substances.

ZS-HLDS150



Protruding objects and steps can be measured from a distance for measurement objects that cannot be accessed easily.

Standard

ZS-L Series



Standard Sensors Ideal for a Variety of High-precision Displacement Measurements, Including Spot Detection, Wide-range Detection, and Long-distance Detection

ZS-LD20ST

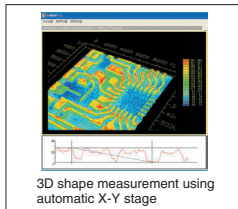

Ideal for measurements requiring discrimination between minute parts or fine shape repeatability.

ZS-LD40T

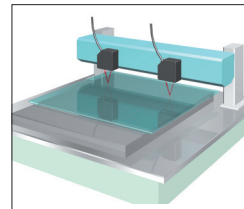

Ideal for measuring glass thickness and nozzle gaps when coating glass with resist or sealer.

ZS-LD50/LD80

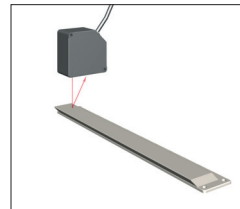

Ideal for measuring the warp of resin blades in copy machine toners.

ZS-LD200

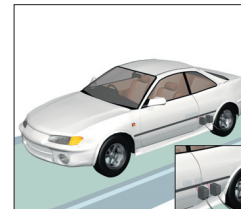

Ideal for checking the precision of door installations.

ZS-LD350S

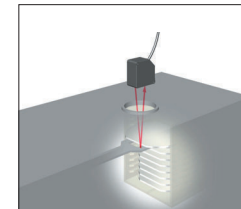

Ideal for checking the flatness of robot arms that transport wafers in load ports.

Applications by Industry

Automobile and Automotive Parts

Measuring Car Bodies

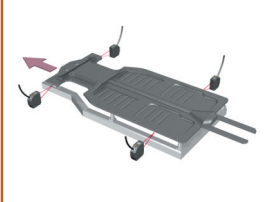

Measuring Door Attachment Offsets

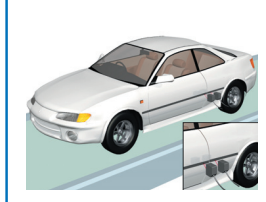

Measuring Tire Exteriors

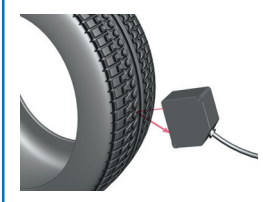

Semiconductors

Measuring Electrode Thickness on Compound Semiconductors

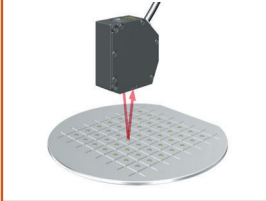

Measuring Wafer Warping and Thickness

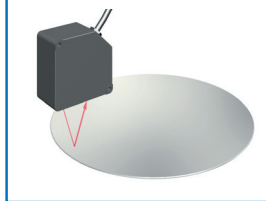

Measuring Arm Inclination

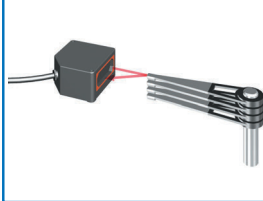

LCDs and PDPs

Measuring Glass Undulation

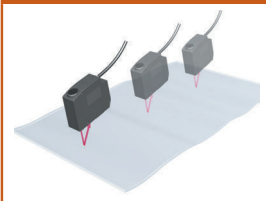

Measuring Glass Surfaces

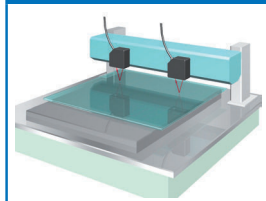

Inspecting Glass Heights (Autofocus)

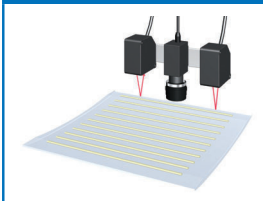

Electronic Components

Inspecting Board Heights

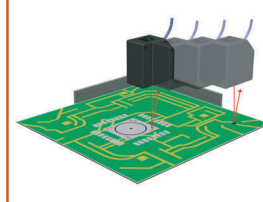

Inspecting for Board Coplanarity

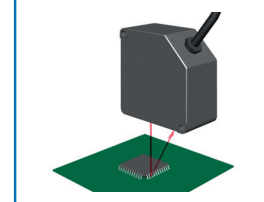

Measuring Shape for Positioning Laminated Ceramics

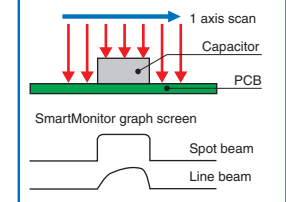

Household Appliances and Audio-visual

Simultaneous Measuring of Touch Panel Film Thickness and Gap

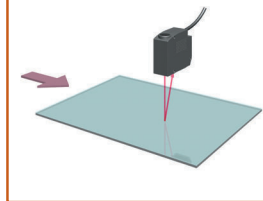

DVD Chassis Flatness Inspections

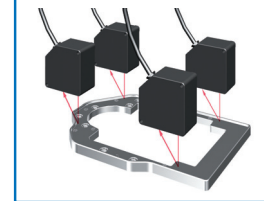

Digital Camera Tube Lens Inspection

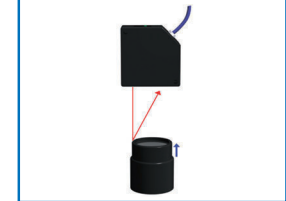

Rubber, Resin, and Film

Measuring Electrode Thickness on Dielectrics

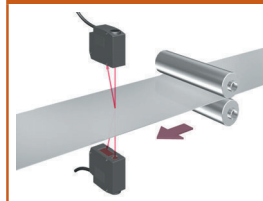

Moving Workpieces (Black Rubber)

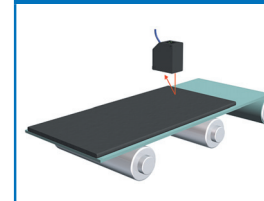

Measuring Depth of O-Ring Insertion



High-performance Sensors

High grade

ZS-HL Series Product Lineup 2D CMOS High-end Displacement Sensors

Advanced sensing technology packed into the best Sensor Head for the highest sensing precision

Wide lineup of products from 0.25 μm high-resolution models to 1,500 mm long-range models.

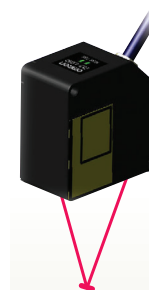

| Model | ZS-HLDS150 | ZS-HLDS60 | ZS-HLDS10 | ZS-HLDS5T | ZS-HLDS2T | ZS-HLDS2VT | ZS-LD10GT/LD15GT |
|---------------------------|-----------------------|-----------------------|----------------------------------|--------------------------------|--------------------------------|----------------------------------|---|
| Measuring center distance | 1500 \pm 500 mm | 600 \pm 350 mm | 100 \pm 20 mm | 50 \pm 5 mm | 20 \pm 1 mm | 25 \pm 2 mm | 10 \pm 0.5 mm / 15 \pm 0.75 mm |
| Resolution | 500 μm | 8 μm | 1 μm | 0.25 μm | 0.25 μm | 0.6 μm | 0.25 μm |
| Linearity | \pm 0.2%F.S. | \pm 0.07%F.S. | \pm 0.1%F.S. | \pm 0.1%F.S. | \pm 0.05%F.S. | \pm 0.2%F.S. | \pm 0.1%F.S. |
| Beam shape | 1.5 mm \times 40 mm | 0.3 mm \times 16 mm | 60 μm \times 3.5 mm | 30 μm \times 1 mm | 20 μm \times 1 mm | 45 μm \times 2.2 mm | 25 μm \times 900 μm |

All Models Are Class 2 Lasers.

Digital Sensing

Totally reliable measurements with completely digital sensing.

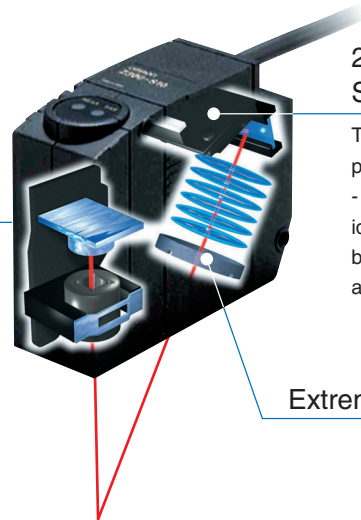

2D CMOS Laser Image Sensing Element

The three basics of sensing - precision, speed, and sensitivity - can be balanced because ideal measurement settings can be made for light reception area.

Extremely Sensitive Lenses

$\pm 0.05\%$ FS Linearity (ZS-HLDS2T)

Unique OMRON algorithms reduce detection error to improve workpiece measurement accuracy.

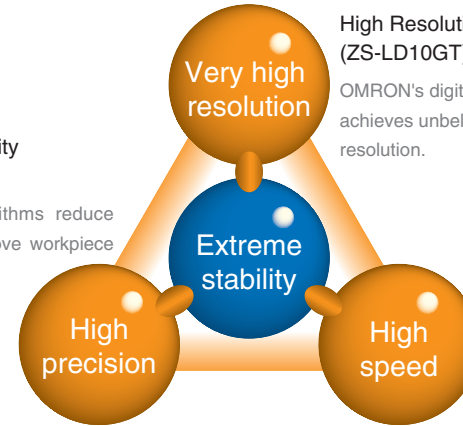

High Resolution at $0.001 \mu\text{m}$ (ZS-LD10GT)

OMRON's digital sensing technology achieves unbelievably high resolution.

Super-high-speed Sampling at $110 \mu\text{s}$ (ZS-HLDS□□/LD□□)

You get exact sensing with superior workpiece following performance. CMOS high-speed data reading accurately catches moving workpieces inline.

Extreme Stability

Ideal Size and Stability

Head Size

Complete sensing stability with optimum Sensor Head size for best performance and holding mechanism secured at 3 points. (See note.)



◀ ZS-HLDS60/HLDS150

▲ ZS-HLDS2T ▲ ZS-HLDS5T/HLDS10



Note: ZS-HLDS2T not applicable.

Superior Moving Resolution

Increased Lens Resolution

Moving resolution (error based on workpiece surface position) has been reduced dramatically by optimizing the optical system with increased sensitivity and resolution of the light receiving lenses.

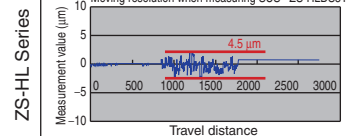
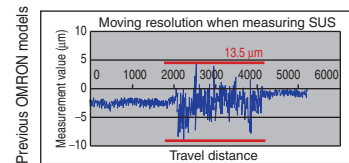

Sampling: 4 ms

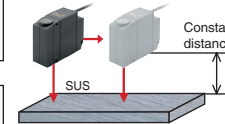

Reduced Error for Different Materials

2D CMOS

With a CCD, the charge overflows to the next pixel when excessive light is received. This phenomenon does not occur with CMOS, so there are no effects from light fluctuations from different materials or excessive light reception.

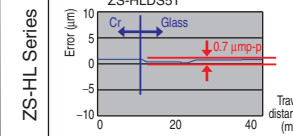
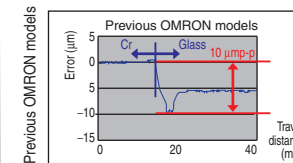

Sampling: 4 ms

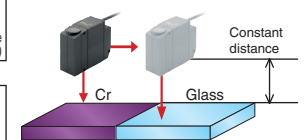

High-performance Sensors

High grade

High-performance Sensors

ZS-HLDS5T/HLDS10 Detect Essentially Any Object

Reduced Variation in Linearity between Different Objects, and Linearity Determines Measurement Accuracy.
Makes it easier to introduce a variety of detection objects.



| | |
|---------------------------|------------------|
| Model | ZS-HLDS5T |
| Measuring center distance | 50±5 mm |
| Resolution | 0.25 μm |
| Linearity | ±0.1%F.S. |
| Beam shape | 30 μm × 1 mm |

| | |
|---------------------------|------------------|
| Model | ZS-HLDS10 |
| Measuring center distance | 100±20 mm |
| Resolution | 1 μm |
| Linearity | ±0.1%F.S. |
| Beam shape | 60 μm × 3.5 mm |

Linearity Characteristic

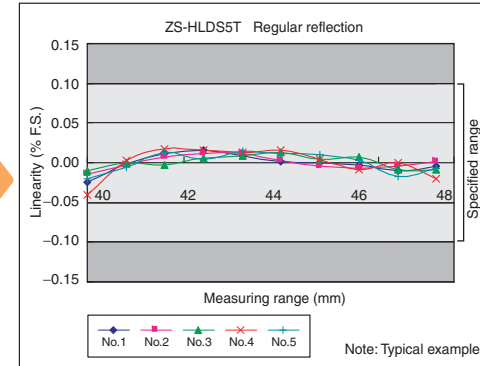
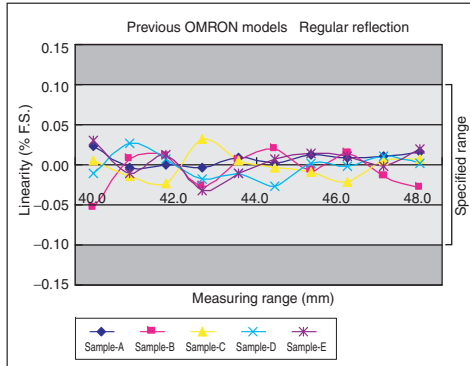

Measuring Car Body Widths (ZS-HLDS10)



Manage trends by measuring widths of each car model.

ZS-HLDS60/HLDS150 A Long Range That Handles Essentially Any Installation Site

First 1,500 mm long range sensing in the industry enables measurement of previously impossible points.



| | |
|---------------------------|------------------|
| Model | ZS-HLDS60 |
| Measuring center distance | 600±350 mm |
| Resolution | 8 μm |
| Linearity | ±0.07%F.S. |
| Beam shape | 0.3 mm × 16 mm |

| | |
|---------------------------|-------------------|
| Model | ZS-HLDS150 |
| Measuring center distance | 1500±500 mm |
| Resolution | 500 μm |
| Linearity | ±0.2%F.S. |
| Beam shape | 1.5 mm × 40 mm |

Simple Long-distance Step Measurement



Peak/bottom measurement

Note: This function may not be applicable in bright surrounds.

ZS-HLDS2VT **NEW**

Ideal for Measuring the Height and Thickness of Transparent Objects

Tilted and moving workpieces can also be stably measured.



| | |
|---------------------------|-------------------|
| Model | ZS-HLDS2VT |
| Measuring center distance | 25±2 mm |
| Resolution | 0.6 μm |
| Linearity | ±0.2%F.S. |
| Beam shape | 45 μm × 2.2 mm |

A special aspherical lens was developed for the ZS-HLDS2VT, and the design of the optical structure was optimized for regular-reflective workpieces. This has greatly increased the allowable degree of tilt and improved stability for measuring transparent and regular-reflective workpieces.



Aspherical lens (newly developed)

Angle Characteristics

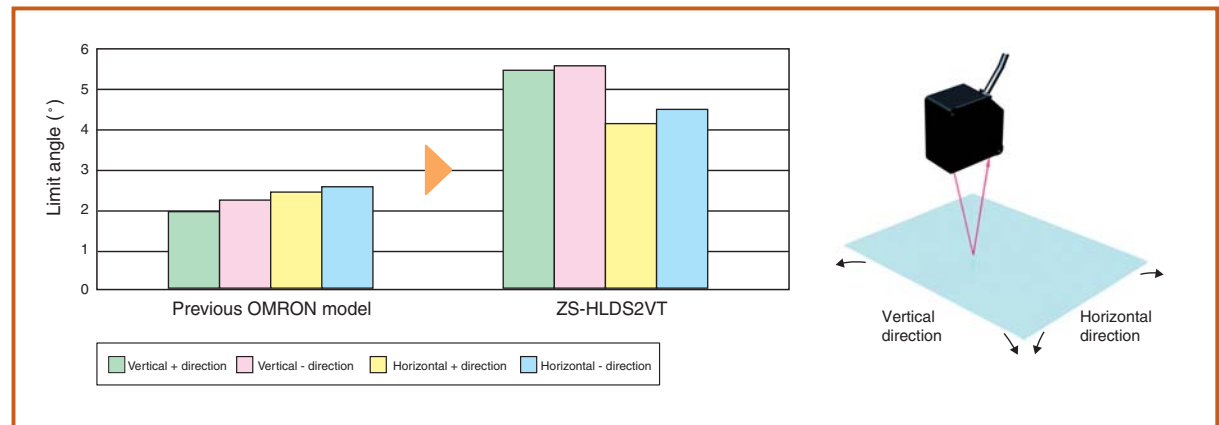

High-performance Sensors

High grade

ZS-HLDS2T/ZS-LD10GT/LD15GT

The Only Way to Very High-precision Measurements

Superior Features for Semiconductor Wafer, Glass, and Other Measurements Requiring Precision



| | |
|---------------------------|------------------|
| Model | ZS-HLDS2T |
| Measuring center distance | 20±1 mm |
| Resolution | 0.25 μm |
| Linearity | ±0.05%F.S. |
| Beam shape | 20 μm × 1 mm |

Simultaneous Measuring of Touch Panel Film Thickness and Gap



Simultaneous measurement of transparent object thickness and gap

An unbelievable stationary measurement precision of 0.25 μm, the highest in this product class.



Ideal for Measuring Nozzle Gaps!

- Reduced pattern influence for moving measurement, the best in the moving resolution industry.
- Possible to match nozzle drip point and measurement point then measure.
- Sensor Head with separate light emission and reception in one unit to create nozzle space.

| | |
|---------------------------|-------------------------|
| Model | ZS-LD10GT/LD15GT |
| Measuring center distance | 10±0.5 mm/15±0.75 mm |
| Resolution | 0.25 μm |
| Linearity | ±0.1%F.S. |
| Beam shape | 25 × 900 μm |



Height Control of Sealant Dispensers



Inspection of Disk Play on HDD Motor Rotating Plate

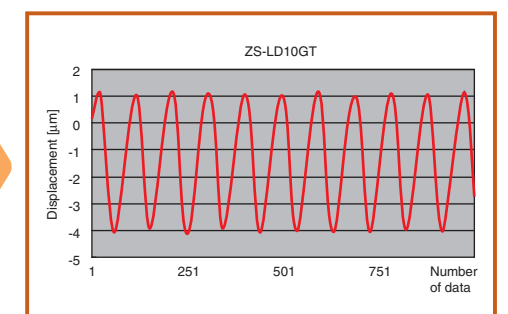

Measures amplitude undulations of 5 μm.

Technology

With OMRON's sensing technology and newly developed algorithms, stable, high-precision measurement is possible of workpieces that were difficult to measure using laser displacement meters due to laser light penetration, transmission, excessive reflection, or insufficient light.

Mechanisms for Stable Measurement **Patent Pending**

No more errors due to reflection coefficients between glass gaps

Stable measurement by adding received light waveform in 2D image and digital zoom processing.



Measurement cycle time 1/8 better than previous models with addition of received light waveform captured by 2D CMOS and simultaneous measurement of front and back glass surfaces with separate sensitivities.

Mechanisms for Stable Measurement **Patent Pending**

No more errors due to workpiece reflection coefficients.

Stable measurement using laser power algorithms that can be adjusted to any value.

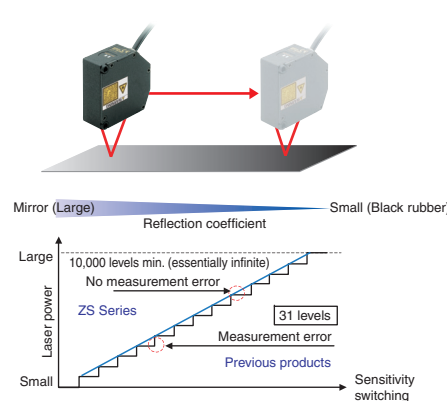

Light quantity adjustment algorithms have evolved for stable measurement of a variety of measurement objects. Even if the workpiece status changes suddenly, the sensitivity can compensate at any level so there is no measurement error from sensitivity switching.

Mechanisms for High Resolution **Patent Pending**

No more resolution errors.

Digital processing technology between the Sensor and Controller provides high resolution.

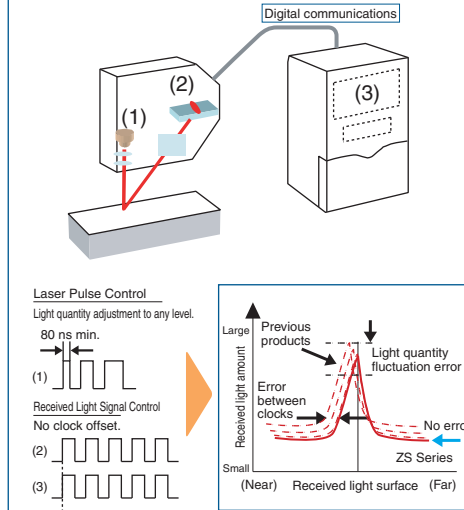

High-speed digital communications (LVDS) used between Sensor and Controller. Image signal stabilizes because the clock error between the control signal from the Controller and the light reception device disappears. Optimum light quantity adjustment is possible with laser power algorithms that can be adjusted to any level, which facilitates super high resolution.

Mechanisms for Stable Measurement

No more error due to penetration.

Stable measurements are achieved by correctly recognizing the light reception distribution on the 2D CMOS.

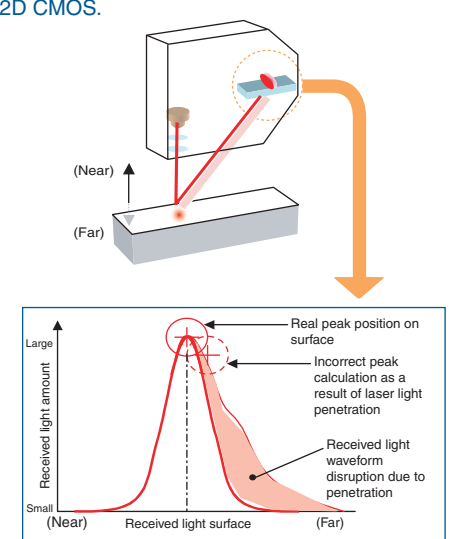

Real surface displacement detected by eliminating penetration effects for PCBs, plastic, and other workpieces penetrated by laser light.

High-performance Sensors

High grade

Sensor Controllers ZS-HLDC (Multitasking)

Enables maximum sensing performance with fully digital processing and multitasking functions.

A controller the size of a business card filled with OMRON's leading-edge digital technology.

Enables easy utilization of the ultimate in measurement performance.



Outline of Functions

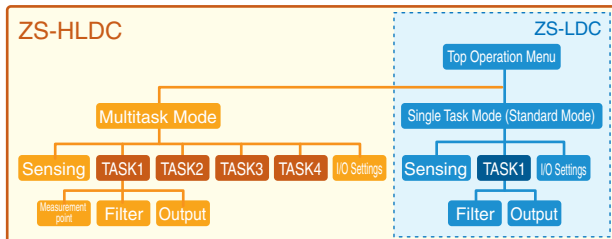

High-performance Sensing (Multitasking)

Simultaneous Measurement and Output of Up to 4 Features

- When simultaneous measurement of distance to glass, glass thickness, gap, etc., required in glass measurement applications

Setting example
 ■Task 1: Average
 ■Task 2: Thickness

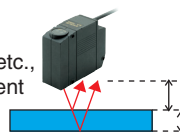

- For simultaneous measurement of HDD surface deflection and distance to HDD surface

Setting example
 ■Task 1: Average, Average hold
 ■Task 2: Average, Point-to-point hold

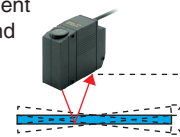

- For detection of small recesses and protrusions in measurement location

Setting example
 ■Task 1: Step

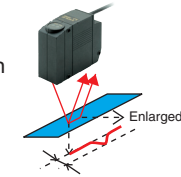

- For measurement of steps in different locations with moving Sensor or workpiece

Setting example
 ■Task 1: Average
 Self-down trigger
 Average hold
 With delay
 ■Task 2: Average
 Average hold
 With delay
 ■Task 3: Calculation (Task 2 - Task 1)

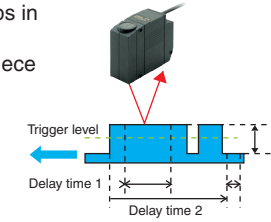

Simultaneous Control in 2 Systems of Data Confirmation and Analysis and Data Collection, Control, and Changeovers

Control Using CompoWay/F*

Data Confirmation and Analysis

- Checks sensing screen.
- Checks measurement values.
- Logs measurement values.



* OMRON's unique communications protocol.

Control Using No-protocol Communications

Data collection, control, and changeovers

- Gets measurement results.
- Resets to zero.
- Switches banks.

Improved Total Cycle Time with 1-second High-speed Bank Switching

Easy Sensing with an HMI That Couldn't Be Easier to Use (Common Functions)

Information at the Touch of a Button

In RUN (measurement) Mode, measured values and information are displayed using 2 rows of 8-segment LEDs. The large LED display improves visibility. Measurement information includes the threshold, current, resolution, and received light amount and is available with simple key operations. LCD screens can be customized to change the display of desired information to easier-to-understand terminology.

RUN
(measurement mode)

Example of
Display Customization



Mount to DIN Track or
directly to control
panels.

Patent Pending



Panel Mounting Adapter (Option, Sold Separately)

Set Sensing Directly Patent Pending

In FUN (setting) Mode, setting menus are displayed on the 2 rows of the LCD. Easy-to-understand guidance simplifies setting the many display capabilities of the LCD. Function keys correspond to displayed menu items for intuitive setting of measurement conditions and other parameters. You can also easily switch between Japanese and English displays. Communication with the operator is better than ever before.



Connect directly to a PC using USB.

USB 2.0 and RS-232C provided as standard features. LVDS, a new-generation digital high-speed communications interface, is used between the Sensor Head and Controller, an industry first. If USB is used to connect to the computer, high-speed all digital measurement data transfer is possible. Firmware can be updated easily using the SmartMonitor WarpEngine.



USB Connection



ZS-LDC Single Task Controller

Simple Operation
Reasonable Price

ZS-L Series Product Lineup 2D CMOS Low-end Displacement Sensors

Advanced sensing technology packed into the smallest Sensor Heads in this class.

- Smallest size in this class (65 × 65 mm)
- Uniform Sensor Head size
- Line/spot beam type
- Detects black rubber, mirror, and transparent workpieces

ZS-LD50/LD80/LD130/LD200/LD350S

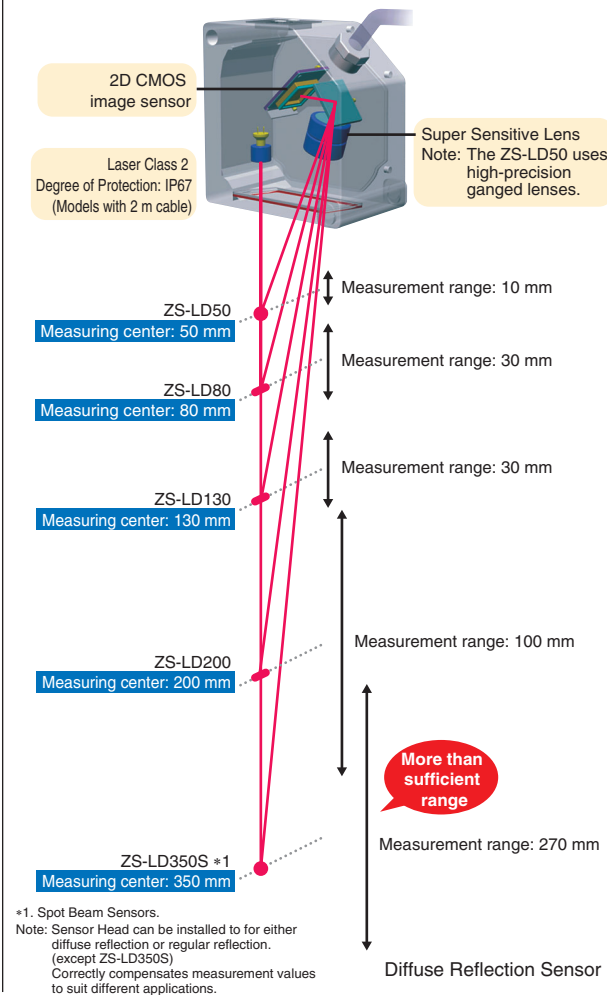

ZS-LD20T/LD40T

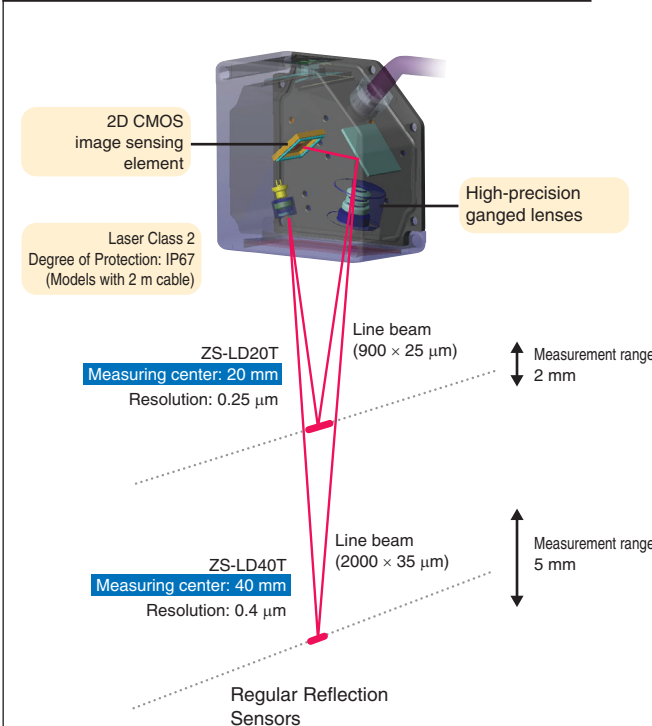

ZS-LD20ST/LD50S

Spot Beam Sensors

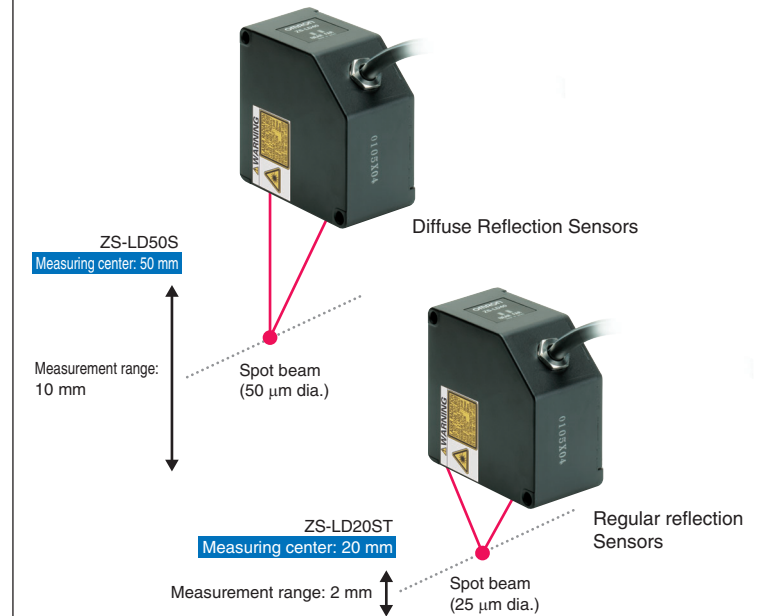

Stable Measurements for PCBs, Black Resin, and Metal

All you need to do is select the proper mode to achieve stable sensing of PCBs, resins, black rubber, and other light-penetrating workpieces (these could not be easily handled with previous reflective laser displacement meters.)

ZS-LD80

Measuring the Shape of Black Resin Workpieces



Complete measurement data will be obtained at angles of up to 40°.

ZS-LD50

Measuring the Shape PCB Surfaces



PCB shapes can be measured without burs or waveform disruptions.

Stable Measurements for Glass

Stably measure height and undulations in transparent, coated, or colored glass on work tables. Stable detection at 40 mm with a line beam of 2 mm.

A 2-mm line beam reduces the influence of black and white patterns on granite work tables to achieve stable measurements.

ZS-LD40T

Measuring Glass Surfaces

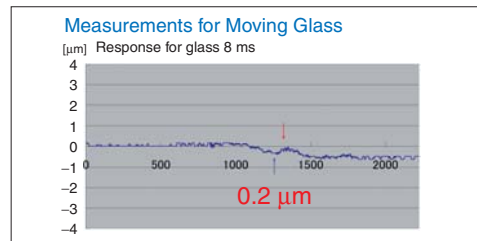
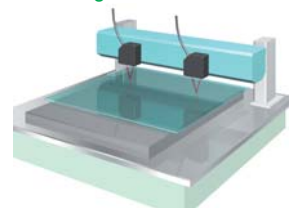

Ideal for measuring glass thickness and slit nozzle gaps when coating glass with resist or sealer.

Line Beam Sensors for Emphasis on Stable Measurement

Line beams produce an averaging affect that is less likely to be affected by surface irregularities, creating stable measurements. Ideal for stable measurements that do not rely on the surface of the target workpiece.

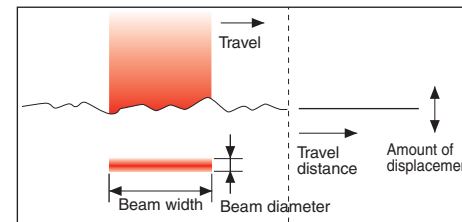

| Line Beam sensors | ZS-LD20T | ZS-LD40T | ZS-LD50 | ZS-LD80 | ZS-LD130 | ZS-LD200 |
|-------------------|----------|----------|---------|---------|----------|----------|
| Beam diameter | 25 μm | 35 μm | 60 μm | 60 μm | 70 μm | 100 μm |
| Beam width | 0.9 mm | 2 mm | 0.9 mm | 0.9 mm | 0.6 mm | 0.9 mm |

Spot Beam Sensors Ideal for Minute Workpieces and Shape Measurement

Ideal for measurements requiring minute shape repeatability while matching laser beam position with a minute target measurement area.



| Spot Beam sensors | ZS-LD20ST | ZS-LD50S | ZS-LD350S |
|-------------------|------------|------------|-------------|
| Beam width | 25 μm dia. | 50 μm dia. | 240 μm dia. |

Easy Sensing with an HMI That Couldn't Be Easier to Use

- Just select High-precision Mode to stably measure black rubber.
- Just select Penetration Mode to stably measure PCBs or black resin.

Set Sensing Directly

FUN (setting mode)



Direct setting with function keys.

Expansion Units

Enhancing unit

System Configuration

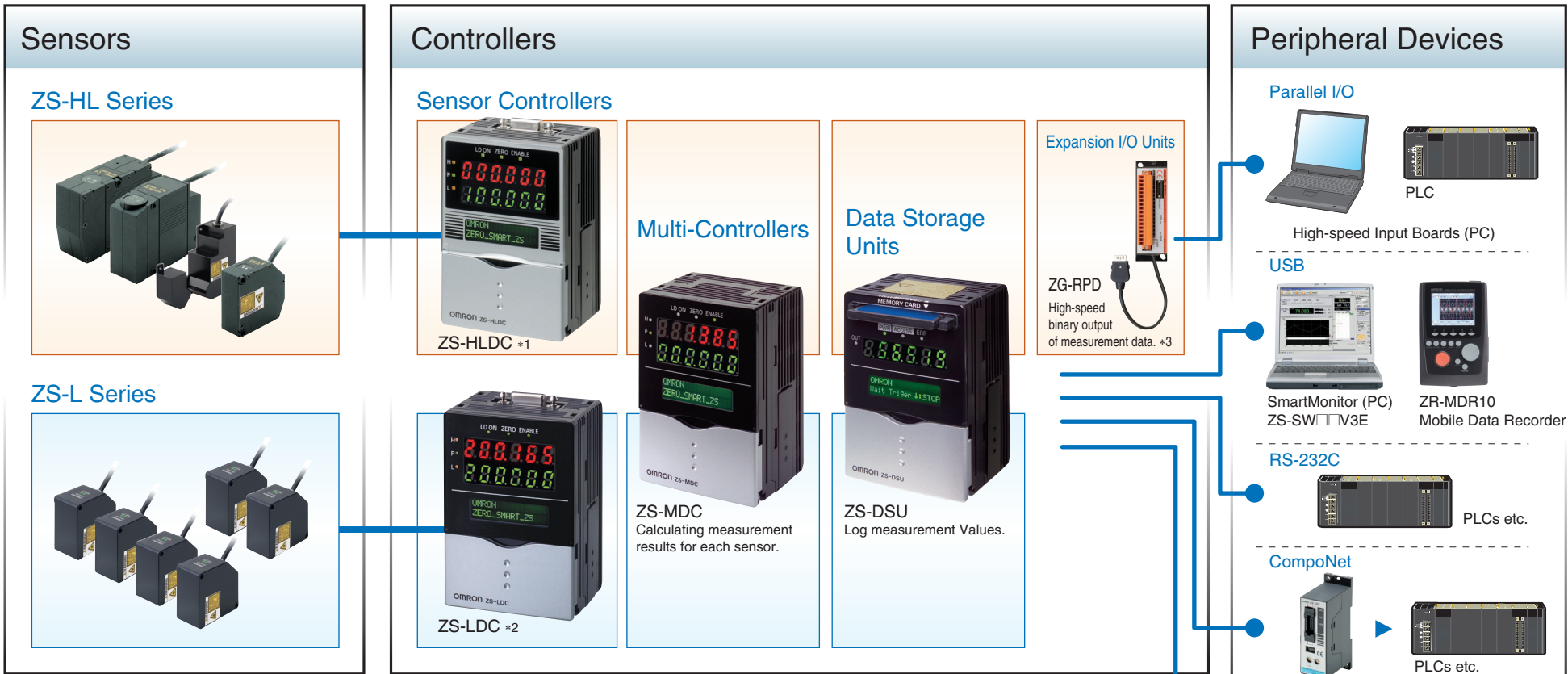

*1: The ZS-HLDC can be connected to a ZS-HL/L-series Sensor Head.
 *2: The ZS-LDC can be connected only to a ZS-L-series Sensor Head.
 *3: The ZG-RPD Expansion I/O Unit can be connected only to a ZS-HL-series Sensor Controller.

ZS-HL-series Long-distance Extension Cable

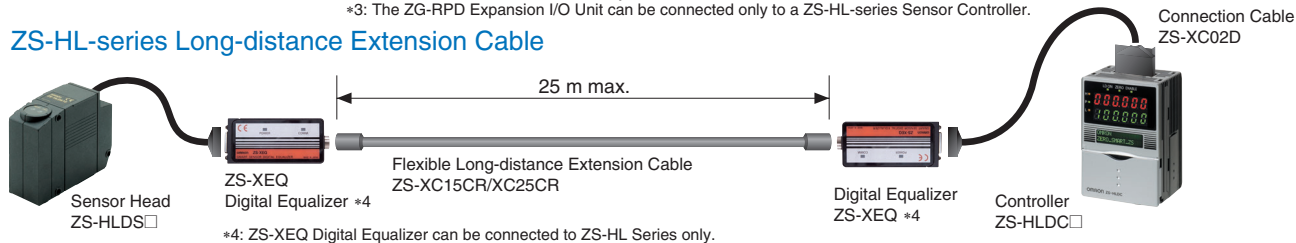

*4: ZS-XEQ Digital Equalizer can be connected to ZS-HL Series only.

Expansion Units

Multi-Controller ZS-MDC

Centralized Controller Information Calculations

Transfers data between multi-connected Controllers and performs high-speed multiprocessing.

High-speed Connections for Up To 9 Controllers

See the difference in applications requiring multipoint measurement, such as thickness, steps, and flatness measurements. Connect up to 9 Controllers with the fastest high-speed bus in the industry. Digital processing prevents data dropouts to provide the capability to measure exactly what is seen.

Sampling speed with 3 Controllers connected: 110 μ s, Sampling speed with 9 Controllers connected: 380 μ s

Note: When using communications commands.

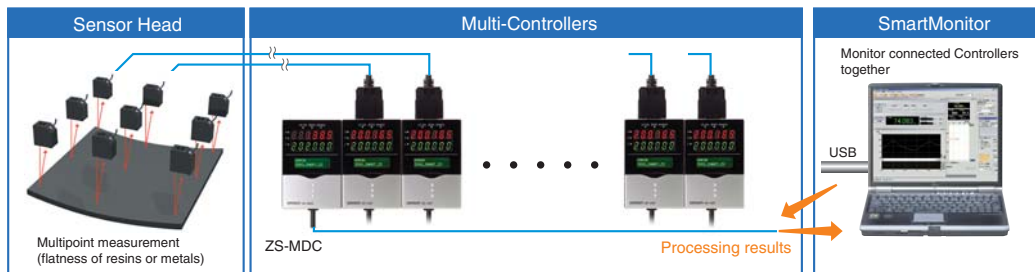

Expansion Units

Processing Enabled by the Multi-Controller

Flatness Calculations

Calculating the difference between the maximum and minimum values.

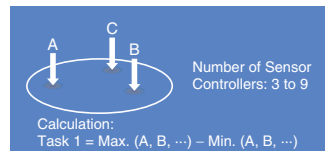

Reference Step Calculations

Calculating the difference between a reference point (A) and other points.

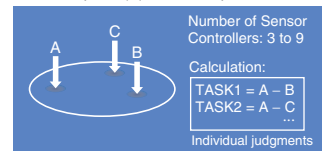

Relative Step Calculations

Calculating the difference between all points.

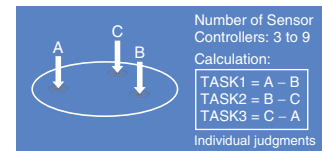

Twisting Calculations

Calculating twisting between opposing sides.

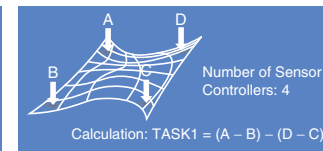

Multipoint Thickness Calculations

Calculating the difference between pairs of points.

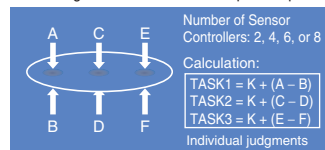

Average Height Calculations

Calculating the average surface height.

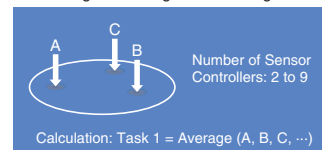

Warp Calculations

Calculating warping of selected sides

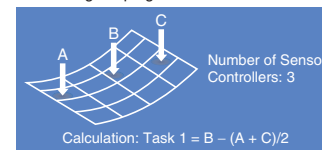

User-set Calculations

Formulas can be flexibly set.

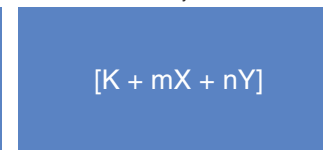

Multi-calculations of Data

Multipoint measurement

High-speed data transfer

Expansion Units

Enhancing unit

Data Storage Unit ZS-DSU

Logging Software for Onsite Installed



Efficiently stores sensing data using a variety of logging functions.
 High-speed, long term logging settings can be used to precisely process the required sensing data, which can be reliably and completely collected using USB and an all-digital bus.
 Sensor setting data can also be stored.
 Data for up to 128 banks can be stored and transferred to the Master Unit for changeovers.

- High-speed sampling rate: 150 μ s max.
- Powerful support for logging data using various trigger functions.

| | | |
|---------------------|-----------------------------------|---|
| Config-uration | Number of connectable Controllers | 10 max. (ZS-MDC: 1, ZS-HLDC/LDC: 9 max.) |
| | Connectable Controllers | ZS-HLDC□, ZS-LDC□, ZS-MDC□ |
| Perform-ance | Data resolution | 32 bits |
| | Sampling rate | <ul style="list-style-type: none"> • Shortest high-speed logging mode (One-shot Mode) *1 • Long-term logging mode (Repeat Mode) *2 • Sampling period: 10 ms to 1 h (at 1-ms intervals) |
| Func-tions | Trigger functions | Start and end triggers can be set separately. External trigger/data trigger (self-trigger) Time triggers |
| | Other functions | <ul style="list-style-type: none"> • External bank function • Alarm output function • Saved data format customization function • Time function (timestamps) |
| Software (included) | | <ul style="list-style-type: none"> • CSV file generation Software • Excel macros for simple analysis (Equivalent to software provided with SmartMonitor Professional.) |

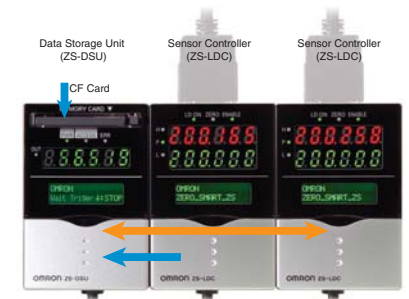

Data Storage Unit
ZS-DSU

Multipoint data collection

Traceability

Changeover Unit

*1) For One-shot Mode

• Connected to ZS-LDC

| Number of channels | Min. sampling interval | Longest logging time |
|--------------------|------------------------|----------------------|
| 1 | 150 μ s | 10 min |
| 2 | 200 μ s | 6.5 min |
| 4 | 350 μ s | 5.5 min |
| 9 | 650 μ s | 4.5 min |

Typical examples

*2) For Repeat Mode (Logging time depends on capacity of Memory Card.)

• Example for 64-MB Memory Card

| Number of channels | Min. sampling interval | Longest logging time |
|--------------------|------------------------|----------------------|
| 1 | 10 ms | 20 h |
| 2 | 10 ms | 10 h |
| 4 | 10 ms | 5 h |
| 9 | 10 ms | 2 h |

Typical examples

• Connected to ZS-MDC

| Number of channels | Min. sampling interval | Longest logging time |
|--------------------|------------------------|----------------------|
| 1 | 350 μ s | 20 min |
| 2 | 400 μ s | 12 min |
| 4 | 500 μ s | 8 min |
| 9 | 700 μ s | 5 min |

Typical examples

Setting Software for ZS Series SmartMonitor V3 Professional ZS-SW11V3E

Use a Computer for Everything from Ideal ZS Settings to Powerful Support of Data Collection and Analysis.
Easy Settings Using USB.

More Powerful Setting Support

The CMOS light reception image and the received light waveform can be displayed. The real power of the SmartMonitor is seen when measuring transparent objects and other workpieces that create multiple received light waveforms.

●Received Light Monitor



High-speed simultaneous multichannel waveform graphs.

High-speed display: 2-ms interval at max. speed (see note);
Simultaneous multichannel waveform display: Up to 9 waveforms can be displayed.

Note: Data may be skipped, depending on the computer system. Use a computer that meets the recommended system requirements.

●Multi-channel Waveform Display



Meets a wide range of logging needs.

Log measurement results at various times to leave judgment and inspection results.

The fastest sampling interval is 500 μs (see note).

Note: Data may be skipped, depending on the computer system.

Use a computer that meets the recommended system requirements.

●Logging

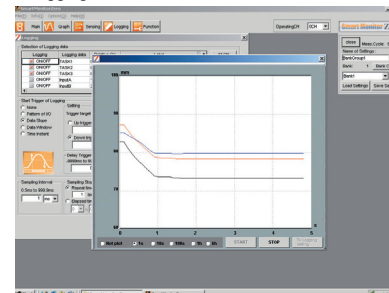

Excel macro provided for simple analysis.

Data collected by logging can be processed with an Excel macro using filters, slope compensation, filter median transitions, differentiation, integration, and arithmetic functions and then used for nominal judgments and other determinations.

●Analysis

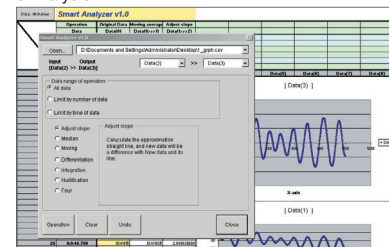

Recommended System Requirements
SmartMonitor Professional
OS: Windows 2000/XP
CPU: Pentium III 850 MHz or greater (2 GHz min. recommended.)
Memory: 128 MB min. (256 MB min. recommended)
Available hard disk space: 50 MB min.
Display screen: 800 × 600 dots, High Color (16 bits) min.
(1,024 × 768 dots, True Color (32 bits) min. recommended)

Note: If the recommended system requirements are not met, data may be interrupted and waveforms not displayed correctly when using the logging, high-speed graph drawing, and multi-channel waveform drawing functions.

SmartAnalyzer Macro Edition
For Microsoft Excel Macro Programming
Microsoft Excel 2000 or later required.

Ratings and Specifications

Specification

Ordering Information Smart Sensor

ZS-HL-series Sensor Heads

| Optical system | Sensing distance | Beam shape | Beam diameter | Resolution (see note 1.) | Model |
|---------------------------|------------------|------------|----------------|--------------------------|------------|
| Regular Reflective Models | 20±1 mm | Line beam | 1.0 mm × 20 μm | 0.25 μm | ZS-HLDS2T |
| | 25±2 mm | Line beam | 2.2 mm × 45 μm | 0.6 μm | ZS-HLDS2VT |
| Diffuse Reflective Models | 50±5 mm | Line beam | 1.0 mm × 30 μm | 0.25 μm | ZS-HLDS5T |
| | 100±20 mm | Line beam | 3.5 mm × 60 μm | 1 μm | ZS-HLDS10 |
| | 600±350 mm | Line beam | 16 mm × 0.3 mm | 8 μm | ZS-HLDS60 |
| | 1500±500 mm | Line beam | 40 mm × 1.5 mm | 500 μm | ZS-HLDS150 |

Note 1: Refer to the table of ratings and specifications for details.

2: Specify the cable length when ordering.

ZS-HL-series Sensor Heads (For Nozzle Gaps)

| Optical system | Sensing distance | Beam shape | Beam diameter | Resolution (see note 1.) | Model |
|---------------------------|------------------|------------|---------------|--------------------------|-----------|
| Regular Reflective Models | 10±0.5 mm | Line beam | 900 × 25 μm | 0.25 μm | ZS-LD10GT |
| | 15±0.75 mm | Line beam | 900 × 25 μm | 0.25 μm | ZS-LD15GT |

Note 1: Refer to the table of ratings and specifications for details.

2: Specify the cable length when ordering.

ZS-L-series Sensor Heads

| Optical system | Sensing distance | Beam shape | Beam diameter | Resolution (see note 1.) | Model |
|---------------------------|------------------|------------|---------------|--------------------------|-----------|
| Regular Reflective Models | 20±1 mm | Line beam | 900 × 25 μm | 0.25 μm | ZS-LD20T |
| | | Spot beam | 25 μm dia. | 0.25 μm | ZS-LD20ST |
| | 40±2.5 mm | Line beam | 2000 × 35 μm | 0.25 μm | ZS-LD40T |
| Diffuse Reflective Models | 50±5 mm | Line beam | 900 × 60 μm | 0.8 μm | ZS-LD50 |
| | | Spot beam | 50 μm dia. | 0.8 μm | ZS-LD50S |
| | 80±15 mm | Line beam | 900 × 60 μm | 2 μm | ZS-LD80 |
| | 130±15 mm | Line beam | 600 × 70 μm | 3 μm | ZS-LD130 |
| | 200±50 mm | Line beam | 900 × 100 μm | 5 μm | ZS-LD200 |
| | 350±135 mm | Spot beam | 240 μm dia. | 20 μm | ZS-LD350S |

Note 1: No. of samples to average: 128 when set to High-precision Mode.

2: Specify the cable length when ordering.

ZS-HL-series Sensor Controllers

| Shape | Supply voltage | Control outputs | Model |
|---|----------------|-----------------|-----------|
|  | 24 VDC | NPN outputs | ZS-HLDC11 |
| | | PNP outputs | ZS-HLDC41 |

ZS-L-series Sensor Controllers

| Shape | Supply voltage | Control outputs | Model |
|---|----------------|-----------------|----------|
|  | 24 VDC | NPN outputs | ZS-LDC11 |
| | | PNP outputs | ZS-LDC41 |

Multi-Controllers

| Shape | Supply voltage | Control outputs | Model |
|---|----------------|-----------------|----------|
|  | 24 VDC | NPN outputs | ZS-MDC11 |
| | | PNP outputs | ZS-MDC41 |

Data Storage Units

| Shape | Supply voltage | Control outputs | Model |
|---|----------------|-----------------|----------|
|  | 24 VDC | NPN outputs | ZS-DSU11 |
| | | PNP outputs | ZS-DSU41 |

Accessories (Sold Separately)

Controller Link Unit

| Shape | Model |
|---|--------|
|  | ZS-XCN |

Panel Mount Adapter

| Shape | Model | |
|---|---------|--|
|  | ZS-XPM1 | For 1st Controller |
|  | ZS-XPM2 | For expansion (from 2nd Controller on) |

RS-232C Cables

| Connected to | Model | Qty |
|-------------------------|---------|-----|
| Personal computer (2 m) | ZS-XRS2 | 1 |
| PLC/PT (2 m) | ZS-XPT2 | 1 |

Extension Cables for Sensor Heads

| Cable length | Model | Qty |
|--------------|------------------|-----|
| 1 m | ZS-XC1A | 1 |
| 4 m | ZS-XC4A | 1 |
| 5 m | ZS-XC5B (*1, *2) | 1 |
| 8 m | ZS-XC8A | 1 |
| 10 m | ZS-XC10B (*1) | 1 |

*1. Up to two ZS-XC□B Cables can be connected. (22 m max.)

*2. A Robot Cable (ZS-XC5BR) is also available.

Long Extension Cables for Sensor Heads (Used with a Digital Equalizer for ZS-HL Series)

| Name | Model | Qty |
|--|-----------|-----|
| Digital Equalizer (Relay) | ZS-XEQ | 1 |
| Extension Cable (long distance, flexible 15 m cable) | ZS-XC15CR | 1 |
| Extension Cable (long distance, flexible 25 m cable) | ZS-XC25CR | 1 |
| Digital Equalizer Connection Cable (0.2 m) | ZS-XC02D | 1 |

Logging Software

| Name | Model |
|---------------------------|------------|
| SmartMonitor Professional | ZS-SW11V3E |

Realtime Parallel Output Unit (for ZS-HL Series)

| Shape | Control outputs | Model |
|---|-----------------|----------|
|  | NPN outputs | ZG-RPD11 |
| | PNP outputs | ZG-RPD41 |

CompoNet-compatible Sensor Communications Unit.

| Shape | Model |
|---|--------|
|  | ZS-CRT |

Memory Cards

| Model | Capacity |
|------------|------------|
| F160-N128S | 128 Mbytes |
| F160-N256S | 256 Mbytes |

Ratings and Specifications

ZS-HL/L-series Sensor Controllers

| Item | Model | ZS-HLDC11/LDC11 | ZS-HLDC41/LDC41 | |
|---------------------------|-------------------------------------|--|--|---|
| No. of samples to average | | 1, 2, 4, 8, 16, 32, 64, 128, 256, 512, 1,024, 2,048, or 4,096 | | |
| Number of mounted Sensors | | 1 per Sensor Controller | | |
| External interface | Connection method | Serial I/O: connector, Other: pre-wired (Standard cable length: 2 m) | | |
| | Serial I/O | USB 2.0 | 1 port, Full Speed (12 Mbps max.), MINI-B | |
| | | RS-232C | 1 port, 115,200 bps max. | |
| | Output | Judgment output | HIGH/PASS/LOW 3 outputs NPN open collector, 30 VDC, 50 mA max., residual voltage 1.2 V max. | HIGH/PASS/LOW: 3 outputs PNP open collector, 50 mA max., residual voltage 1.2 V max. |
| | | Linear output | Selectable from 2 types of output, voltage or current (selected by slide switch on bottom). <ul style="list-style-type: none"> Voltage output: -10 to 10 V, output impedance: 40 Ω Current output: 4 to 20 mA, maximum load resistance: 300 Ω | |
| Inputs | Laser OFF, ZERO reset timing, RESET | ON: Short-circuited with 0 V terminal or 1.5 V or less OFF: Open (leakage current: 0.1 mA max.) | ON: Short-circuited to supply voltage or within 1.5 V of supply voltage. OFF: Open (leakage current: 0.1 mA max.) | |
| Functions | | Display: Measured value, threshold value, voltage/current, received light amount, and resolution/terminal block output *2 Sensing: Mode, gain, measurement object, head installation Measurement point *1: Average, peak, bottom, thickness, step, and calculations Filter: Smooth, average, and differentiation Outputs: Scaling, various hold values, and zero reset I/O settings: Linear (focus/correction), judgments (hysteresis and timer), non-measurement, and bank (switching and clear) *2 System: Save, initialization, measurement information display, communications settings, key lock, language, and data load Task: ZS-HLDC□1: Single task or multitask (up to 4) ZS-LDC□1: Single task | | |
| Status indicators | | HIGH (orange), PASS (green), LOW (orange), LDON (green), ZERO (orange), and ENABLE (green) | | |
| Segment display | Main digital | 8-segment red LED, 6 digits | | |
| | Sub-digital | 8-segment green LEDs, 6 digits | | |
| LCD | | 16 digits x 2 rows, Color of characters: green, Resolution per character: 5 x 8 pixel matrix | | |
| Setting inputs | Setting keys | Direction keys (UP, DOWN, LEFT, and RIGHT), SET key, ESC key, MENU key, and function keys (1 to 4) | | |
| | Slide switch | Threshold switch (2 states: High/Low), mode switch (3 states: FUN, TEACH, and RUN) | | |
| Power supply voltage | | 21.6 V to 26.4 VDC (including ripple) | | |
| Current consumption | | 0.5 A max. (when Sensor Head is connected) | | |
| Ambient temperature | | Operating: 0 to 50°C, Storage: -15 to +60°C (with no icing or condensation) | | |
| Ambient humidity | | Operating and storage: 35% to 85% (with no condensation) | | |
| Degree of protection | | IP20 (IEC60529) | | |
| Materials | | Case: Polycarbonate (PC) | | |
| Cable length | | 2 m | | |
| Weight | | Approx. 280 g (excluding packing materials and accessories) | | |
| Accessories | | Ferrite core (1), instruction sheet | | |

*1. Can be used with ZS-HLDC□1 when Multitask Mode selected.

*2. Terminal block output is a function of the ZS-HLDC□1.

Ratings and Specifications

ZS-HL-series Sensor Heads

| Item | Model | ZS-HLDS2T | ZS-HLDS2VT | ZS-HLDS5T | ZS-HLDS10 | ZS-HLDS60 | ZS-HLDS150 | |
|--------------------------------|----------------|---|---|--|--------------------------------------|--|---|--|
| Applicable Controllers | | ZS-HLDC series | | | | | | |
| Optical system | | Regular reflection | Diffuse reflection | Regular reflection | Diffuse reflection | Regular reflection | Diffuse reflection | |
| Measuring center distance | | 20 mm | 5.2 mm | 25 mm | 50 mm | 44 mm | 100 mm | |
| Measuring range | | ±1 mm | ±1 mm | ±2 mm | ±5 mm | ±4 mm | ±20 mm | |
| Light source | | Visible semiconductor laser (wavelength: 650 nm, 1 mW max., JIS Class 2) | | | | Visible semiconductor laser (wavelength: 658 nm, 1 mW max., JIS Class 2) | | |
| Beam shape | | Line beam | | | | | | |
| Beam diameter *1 | | 1.0 mm × 20 μm | 2.2 mm × 45 μm | 1.0 mm × 30 μm | 3.5 mm × 60 μm | | 16 × 0.3 mm (at 500 mm) | |
| Linearity *2 | | ±0.05%F.S. | ±0.2%F.S. | ±0.1%F.S. | | | ±0.07%F.S. (250 to 750 mm), ±0.1%F.S. (750 to 950 mm) | |
| Resolution *3 | | 0.25 μm (No. of samples to average: 256) | 0.6 μm (No. of samples to average: 128) | 0.25 μm (No. of samples to average: 512) | 1 μm (No. of samples to average: 64) | | 8 μm (No. of samples to average: 64 at 250 mm), 40 μm (No. of samples to average: 64 at 600 mm) | |
| Temperature characteristic *4 | | 0.01%F.S./°C | 0.1%F.S./°C | 0.01%F.S./°C | | | | |
| Sampling cycle | | 110 μs (High-speed Mode), 500 μs (Standard Mode), 2.2 μs (High-precision Mode), 4.4 μs (High-sensitivity Mode) | | | | | | |
| LED Indicators | NEAR indicator | Lights near the measuring center distance, and closer than the measuring center distance inside the measuring range. Flashes when the measurement target is outside of the measuring range or when the received light amount is insufficient. | | | | | | |
| | FAR indicator | Lights near the measuring center distance, and farther than the measuring center distance inside the measuring range. Flashes when the measurement target is outside of the measuring range or when the received light amount is insufficient. | | | | | | |
| Operating ambient illumination | | Illumination on received light surface: 3000 lx or less (incandescent light) | | | | Illumination on received light surface: 1000 lx or less (incandescent light) | Illumination on received light surface: 500 lx or less (incandescent light) | |
| Ambient temperature | | Operating: 0 to 50°C, Storage: -15 to 60°C (with no icing or condensation) | | | | | | |
| Ambient humidity | | Operating and storage: 35% to 85% (with no condensation) | | | | | | |
| Degree of protection | | IP64 | IP67 | Cable length 0.5 m: IP66, cable length 2 m: IP67 | | | IP66 *5 | |
| Materials | | Case: Aluminum die-cast, Front cover: Glass | | | | | | |
| Cable length | | 0.5 m, 2 m | 2 m | 0.5 m, 2 m | | | | |
| Weight | | Approx. 350 g | | Approx. 600 g | | | Approx. 800 g | |
| Accessories | | Laser labels (1 each for JIS/EN), ferrite cores (2), insure locks (2), instruction sheet | | | | | | |

*1. Defined as $1/e^2$ (13.5%) of the center optical intensity at the actual measuring center distance (effective value). The beam diameter is sometimes influenced by the ambient conditions of the workpiece, such as leaked light from the main beam.

*2. This is the error in the measured value with respect to an ideal straight line.
Linearity may change according to the workpiece.
The following options are available.

| Model | Diffuse reflection | Mirror reflection |
|-------------------|-----------------------|-------------------|
| ZS-HLDS2T | SUS block | Glass |
| ZS-HLDS2VT | --- | Glass |
| ZS-HLDS5T | White alumina ceramic | Glass |
| ZS-HLDS10 | White alumina ceramic | --- |
| ZS-HLDS60/HLDS150 | White alumina ceramic | --- |

*3. This is the peak-to-peak displacement conversion value in the displacement output at the measuring center distance in high-precision mode when the number of samples to average is set to within the graph.
The maximum resolution at 250 mm is also shown for the ZS-HLDS60. The following options are available.

| Model | Diffuse reflection | Mirror reflection |
|-------------------|-----------------------|-------------------|
| ZS-HLDS2T | SUS block | Glass |
| ZS-HLDS2VT | --- | Glass |
| ZS-HLDS5T | White alumina ceramic | Glass |
| ZS-HLDS10 | White alumina ceramic | --- |
| ZS-HLDS60/HLDS150 | White alumina ceramic | --- |

*4. This is the value obtained at the measuring center distance when the Sensor and workpiece are fixed by an aluminum jig. (typical example)

*5. Ask your OMRON representative about Sensor Heads with IP67 protection.

Ratings and Specifications

ZS-L-series Sensor Heads

| Item | Model | ZS-LD20T | ZS-LD20ST | ZS-LD40T | ZS-LD10GT | ZS-LD15GT | | | |
|--------------------------------|----------------|---|--------------------|--------------------|--------------------|--------------------|-------|--|----------|
| Applicable Controllers | | ZS-HLDC/LDC Series | | | | | | | |
| Optical system | | Regular reflection | Diffuse reflection | Regular reflection | Diffuse reflection | Regular reflection | | | |
| Measuring center distance | | 20 mm | 6.3 mm | 20 mm | 6.3 mm | 40 mm | 30 mm | 10 mm | 15 mm |
| Measuring range | | ±1 mm | ±1 mm | ±1 mm | ±1 mm | ±2.5 mm | ±2 mm | ±0.5 mm | ±0.75 mm |
| Light source | | Visible semiconductor laser (wavelength: 650 nm, 1 mW max., JIS Class 2) | | | | | | | |
| Beam shape | | Line beam | | Spot beam | | Line beam | | | |
| Beam diameter *1 | | 900 × 25 μm | | 25 μm dia. | | 2000 × 35 μm | | Approx. 25 × 900 μm | |
| Linearity *2 | | ±0.1% FS | | | | | | | |
| Resolution *3 | | 0.25 μm | | 0.25 μm | | 0.25 μm | | 0.25 μm | |
| Temperature characteristic *4 | | 0.04% FS/°C | | 0.04% FS/°C | | 0.02% FS/°C | | 0.04% FS/°C | |
| Sampling cycle | | 110 μs (High-speed Mode), 500 μs (Standard Mode), 2.2 ms (High-precision Mode), 4.4 ms (High-sensitivity Mode) | | | | | | | |
| LED Indicators | NEAR indicator | Lights near the measuring center distance, and closer than the measuring center distance inside the measuring range. Flashes when the measurement target is outside of the measuring range or when the received light amount is insufficient. | | | | | | | |
| | FAR indicator | Lights near the measuring center distance, and farther than the measuring center distance inside the measuring range. Flashes when the measurement target is outside of the measuring range or when the received light amount is insufficient. | | | | | | | |
| Operating ambient illumination | | Illumination on received light surface: 3000 lx or less (incandescent light) | | | | | | | |
| Ambient temperature | | Operating: 0 to 50°C, Storage: -15 to 60°C (with no icing or condensation) | | | | | | | |
| Ambient humidity | | Operating and storage: 35% to 85% (with no condensation) | | | | | | | |
| Degree of protection | | Cable length 0.5 m: IP66, cable length 2 m: IP67 | | | | | | IP40 | |
| Materials | | Case: Aluminum die-cast, Front cover: Glass | | | | | | | |
| Cable length | | 0.5 m, 2 m | | | | | | | |
| Weight | | Approx. 350 g | | | | | | Approx. 400 g | |
| Accessories | | Laser labels (1 each for JIS/EN, 3 for FDA), ferrite cores (2), insure locks (2), instruction sheet | | | | | | Laser safety labels (1 each for JIS/EN), ferrite cores (2), insure locks (2) | |

*1. Defined as $1/e^2$ (13.5%) of the center optical intensity at the actual measuring center distance (effective value). The beam diameter is sometimes influenced by the ambient conditions of the workpiece, such as leaked light from the main beam.

*2. This is the error in the measured value with respect to an ideal straight line. The standard workpiece is white aluminum ceramics and glass in the regular reflection mode. Linearity may change according to the workpiece.

*3. This is the peak-to-peak displacement conversion value in the displacement output at the measuring center distance in high-precision mode when the number of samples to average is set to 128 and the measuring mode is set to the high-resolution mode.
The standard workpiece is white aluminum ceramics and glass in the regular reflection mode.

*4. This is the value obtained at the measuring center distance when the Sensor and workpiece are fixed by an aluminum jig. (typical example)

Ratings and Specifications

ZS-L-series Sensor Heads

| Item | Model | ZS-LD50 | ZS-LD50S | ZS-LD80 | ZS-LD130 | ZS-LD200 | ZS-LD350S | | | | | |
|--------------------------------|----------------|---|--------------------|--------------------|--------------------|--------------------|---|--------------------|--|--------------------|--------------------|--------------------|
| Applicable Controllers | | ZS-HLDC/LDC Series | | | | | | | | | | |
| Optical system | | Diffuse reflection | Regular reflection | Diffuse reflection | Regular reflection | Diffuse reflection | Regular reflection | Diffuse reflection | Regular reflection | Diffuse reflection | Regular reflection | Diffuse reflection |
| Measuring center distance | | 50 mm | 47 mm | 50 mm | 47 mm | 80 mm | 78 mm | 130 mm | 130 mm | 200 mm | 200 mm | 350 mm |
| Measuring range | | ±5 mm | ±4 mm | ±5 mm | ±4 mm | ±15 mm | ±14 mm | ±15 mm | ±12 mm | ±50 mm | ±48 mm | ±135 mm |
| Light source | | Visible semiconductor laser (wavelength: 650 nm, 1 mW max., JIS Class 2) | | | | | | | | | | |
| Beam shape | | Line beam | | Spot beam | | Line beam | | Line beam | | Line beam | | Spot beam |
| Beam diameter *1 | | 900 × 60 μm | | 50 μm dia. | | 900 × 60 μm | | 600 × 70 μm | | 900 × 100 μm | | 240 μm dia. |
| Linearity *2 ±0.1% FS | | ±0.1% FS | | | | | | | | | | |
| Resolution *3 | | 0.8 μm | | 0.8 μm | | 2 μm | | 3 μm | | 5 μm | | 20 μm |
| Temperature characteristic *4 | | 0.02% FS/°C | | 0.02% FS/°C | | 0.01% FS/°C | | 0.02% FS/°C | | 0.02% FS/°C | | 0.04% FS/°C |
| Sampling cycle *5 | | 110 μs (High-speed Mode), 500 μs (Standard Mode), 2.2 ms (High-precision Mode), 4.4 ms (High-sensitivity Mode) | | | | | | | | | | |
| LED Indicators | NEAR indicator | Lights near the measuring center distance, and closer than the measuring center distance inside the measuring range. Flashes when the measurement target is outside of the measuring range or when the received light amount is insufficient. | | | | | | | | | | |
| | FAR indicator | Lights near the measuring center distance, and farther than the measuring center distance inside the measuring range. Flashes when the measurement target is outside of the measuring range or when the received light amount is insufficient. | | | | | | | | | | |
| Operating ambient illumination | | Illumination on received light surface: 3000 lx or less (incandescent light) | | | | | Illumination on received light surface: 2000 lx or less (incandescent light) | | Illumination on received light surface: 3000 lx or less (incandescent light) | | | |
| Ambient temperature | | Operating: 0 to 50°C, Storage: -15 to 60°C (with no icing or condensation) | | | | | | | | | | |
| Ambient humidity | | Operating and storage: 35% to 85% (with no condensation) | | | | | | | | | | |
| Degree of protection | | Cable length 0.5 m: IP66, cable length 2 m: IP67 | | | | | | | | | | |
| Materials | | Case: Aluminum die-cast, Front cover: Glass | | | | | | | | | | |
| Cable length | | 0.5 m, 2 m | | | | | | | | | | |
| Weight | | Approx. 350g | | | | | | | | | | |
| Accessories | | Laser labels (1 each for JIS/EN, 3 for FDA), ferrite cores (2), insure locks (2), instruction sheet | | | | | | | | | | |

*1. Defined as $1/e^2$ (13.5%) of the center optical intensity at the actual measuring center distance (effective value). The beam diameter is sometimes influenced by the ambient conditions of the workpiece, such as leaked light from the main beam.

*2. This is the error in the measured value with respect to an ideal straight line. The standard workpiece is white aluminum ceramics and glass in the ZS-LD50/LD50S regular reflection mode. Linearity may change according to the workpiece.

*3. This is the peak-to-peak displacement conversion value in the displacement output at the measuring center distance in high-precision mode when the number of samples to average is set to 128 and the measuring mode is set to the high-resolution mode.
The standard workpiece is white aluminum ceramics and glass in the ZS-LD50/LD50S regular reflection mode.

*4. This is the value obtained at the measuring center distance when the Sensor and workpiece are fixed by an aluminum jig.

*5. This value is obtained when the measuring mode is set to the high-speed mode. (typical example)

Ratings and Specifications

ZS-MDC□1 Multi-Controllers

Basic specifications are the same as those for the ZS-LDC□1 Sensor Controllers. The following points, however, are different.

1. Sensor Heads cannot be connected.
2. Control Link Units are required to connect up to 9 Controllers.
Control Link Units are required to connect Controllers.
3. Processing functions between Controllers: Arithmetic functions

Controller Link Units

Connection Using the ZS-XCN



ZS-DSU□1 Data Storage Unit

| Item | Model | ZS-DSU11 | ZS-DSU41 |
|-----------------------------------|--|--|--|
| Number of mounted Sensor Heads | | Cannot be connected | |
| Number of connectable Controllers | | 10 max. (ZS-MDC: 1, ZS-HLDC/LDC: 9 max.) *1 | |
| Connectable Controllers | | ZS-HLDC□□, ZS-LDC□□, ZS-MDC□□ | |
| External interface | Connection method | Serial I/O: connector, Other: pre-wired (standard cable length: 2 m) | |
| | Serial I/O | USB 2.0 | 1 port, Full Speed (12 Mbps max.), MINI-B |
| | | RS-232C | 1 port, 115,200 bps max. |
| | Output | 3 outputs: HIGH, PASS, and LOW; NPN open-collector, 30 VDC, 50 mA max., residual voltage: 1.2 V max. | 3 outputs: HIGH, PASS, and LOW; PNP open-collector, 50 mA max., residual voltage: 1.2 V max. |
| Inputs | ON: Short-circuited with 0 V terminal or 1.5 V or less; OFF: Open (leakage current: 0.1 mA max.) | ON: Short-circuited to supply voltage or within 1.5 V of supply voltage; OFF: Open (leakage current: 0.1 mA max.) | |
| Data resolution | | 32 bits | |
| Functions | Logging trigger functions | Start and stop triggers can be set separately; external triggers, data triggers (self-triggers), and time triggers | |
| | Other functions | External banks, alarm outputs, saved data format customization, and clock | |
| Status indicators | | OUT (orange), PWR (green), ACCESS (orange), and ERR (red) | |
| Segment display | | 8-segment green LEDs, 6 digits | |
| LCD | | 16 digits x 2 rows, Color of characters: green, Resolution per character: 5 x 8 pixel matrix | |
| Setting inputs | Setting keys | Direction keys (UP, DOWN, LEFT, and RIGHT), SET key, ESC key, MENU key, and function keys (1 to 4) | |
| | Slide switch | Threshold switch (2 states: High/Low), mode switch (3 states: FUN, TEACH, and RUN) | |
| Power supply voltage | | 21.6 V to 26.4 VDC (including ripple) | |
| Current consumption | | 0.5 A max. | |
| Ambient temperature | | Operating: 0 to 50°C, Storage: 0 to 60°C (with no icing or condensation) | |
| Ambient humidity | | Operating and storage: 35% to 85% (with no condensation) | |
| Materials | | Case: Polycarbonate (PC) | |
| Weight | | Approx. 280 g (excluding packing materials and accessories) | |
| Accessories | | Ferrite core (1), instruction sheet for Data Storage Unit: CSV File Converter for Data Storage Unit/Smart Analyzer Macro Edition | |

*1. Control Link Units are required to connect Controllers.

Dimensions

Sensor Controllers

ZS-HLDC□1/LDC□1



Multi-Controllers

ZS-MDC□1



Data Storage Units

ZS-DSU□1



Dimensions

Sensor Heads

ZS-HLDS2T

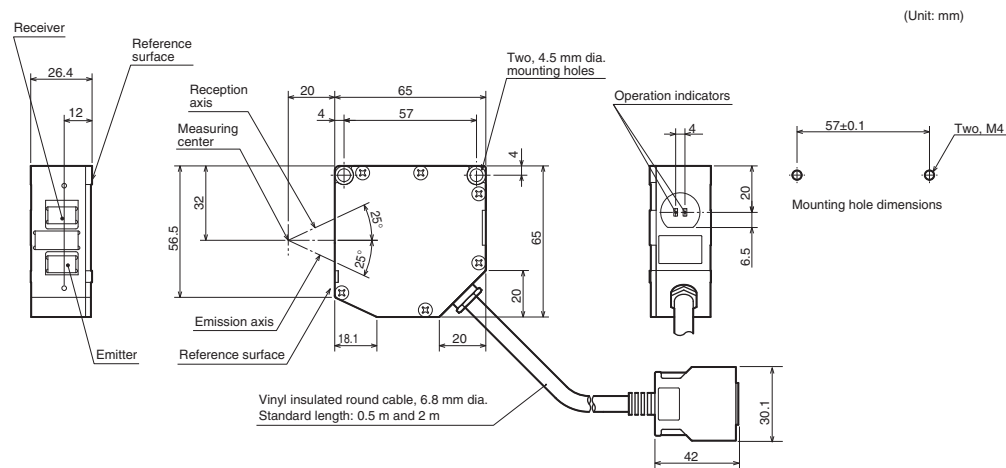

Sensor Heads

ZS-HLDS5T/HLDS10

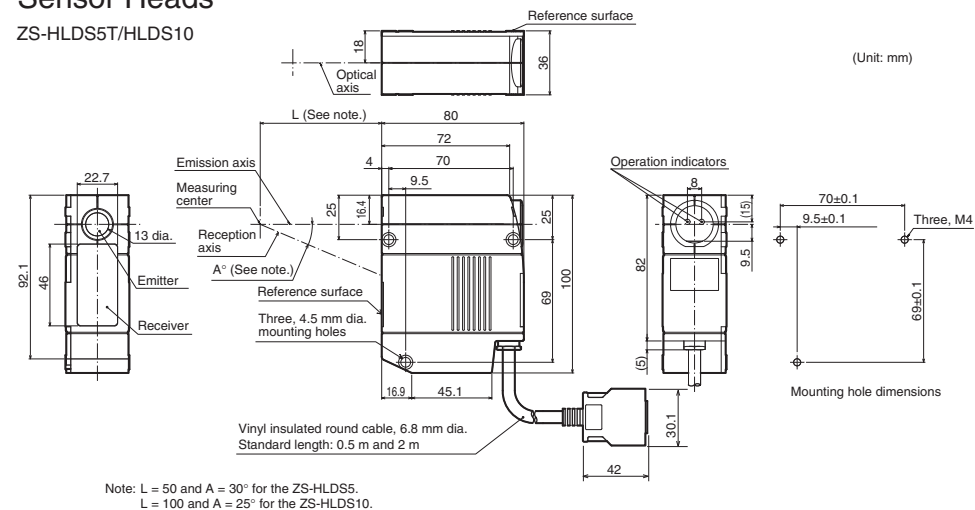

Note: L = 50 and A = 30° for the ZS-HLDS5.
L = 100 and A = 25° for the ZS-HLDS10.

Sensor Heads

ZS-HLDS60/HLDS150

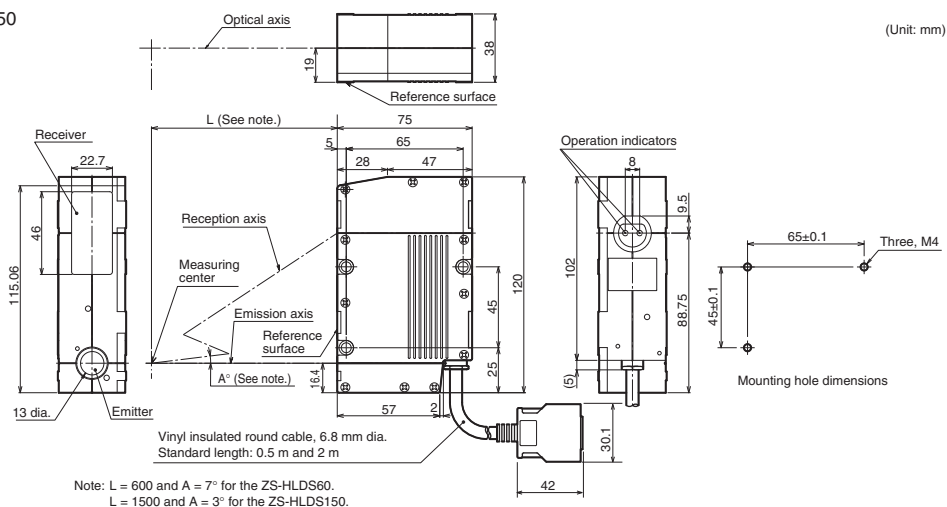

Note: L = 600 and A = 7° for the ZS-HLDS60.
L = 1500 and A = 3° for the ZS-HLDS150.

Dimensions

Sensor Heads

ZS-LD10GT

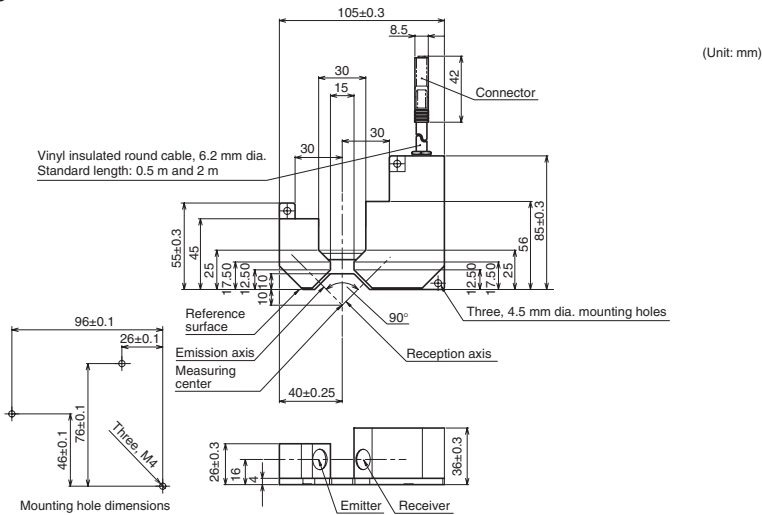

ZS-LD15GT

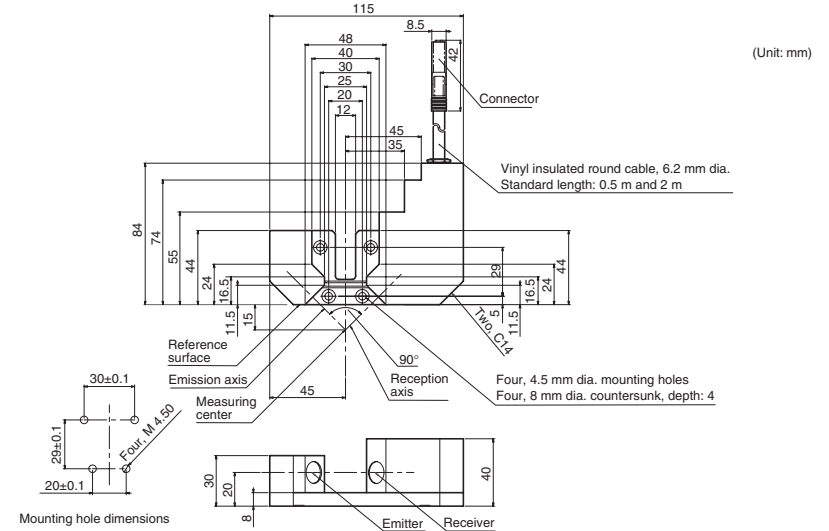

Sensor Heads

ZS-LD50/LD50S/LD80/LD130/LD200/LD350S

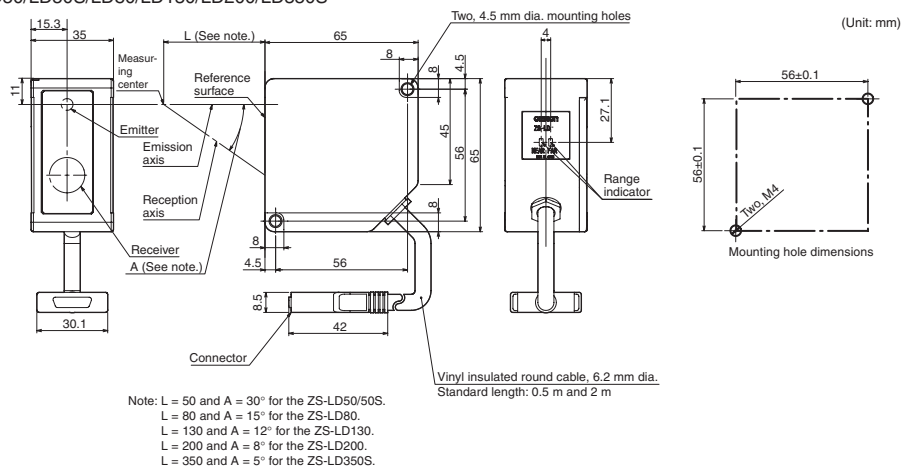

ZS-HLDS2VT/LD20T/LD20ST/LD40T

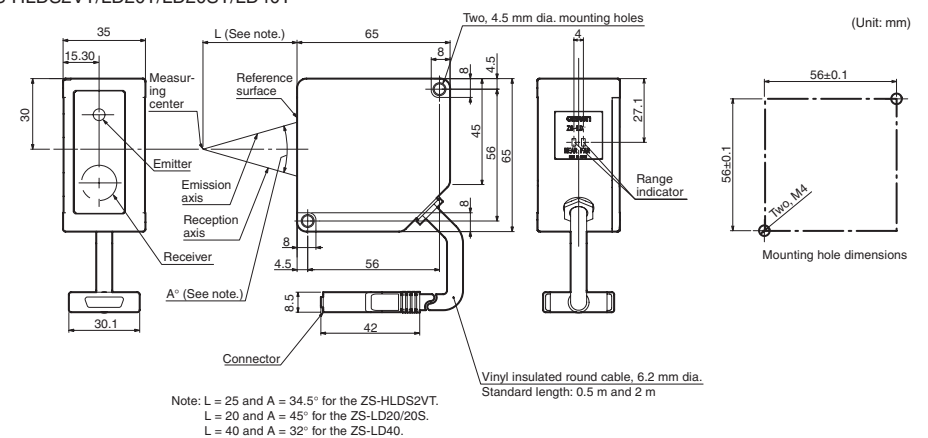

Dimensions

Realtime Parallel Output Unit

ZG-RPD□1

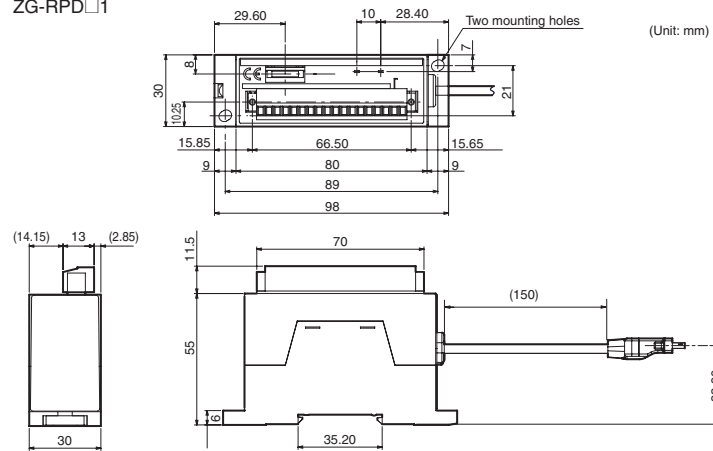

Panel Mount Adapter

ZS-XPM1/XPM2 (Dimensions for Panel Mounting)

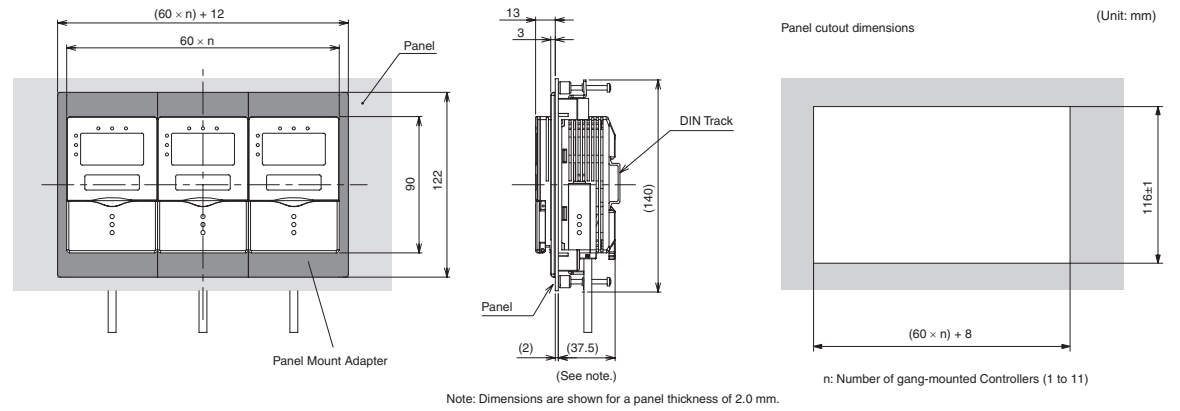

Digital Equalizer

ZS-XEQ

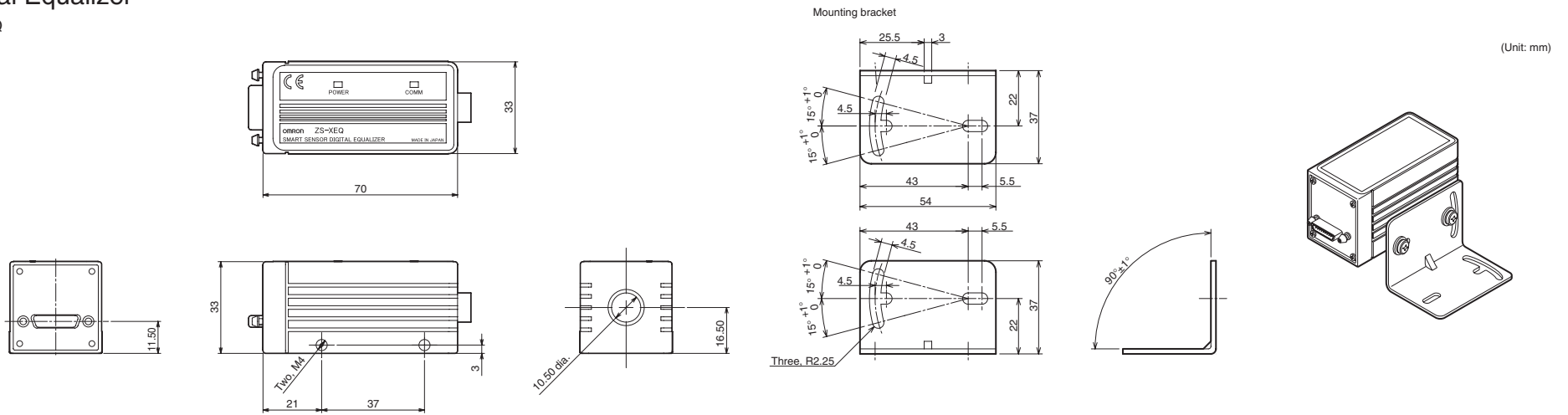

Safety Precautions for Using Laser Equipment

WARNING

Do not expose your eyes to the laser radiation either directly or indirectly (i.e., after reflection from a mirror or shiny surface). The laser radiation has a high power density and exposure may result in loss of sight.

Laser Label Indications

Attach the following warning label to the side of the ZS series Sensor Head.

READ AND UNDERSTAND THIS DOCUMENT

Please read and understand this document before using the products. Please consult your OMRON representative if you have any questions or comments.

WARRANTY

OMRON's exclusive warranty is that the products are free from defects in materials and workmanship for a period of one year (or other period if specified) from date of sale by OMRON.

OMRON MAKES NO WARRANTY OR REPRESENTATION, EXPRESS OR IMPLIED, REGARDING NON-INFRINGEMENT, MERCHANTABILITY, OR FITNESS FOR PARTICULAR PURPOSE OF THE PRODUCTS. ANY BUYER OR USER ACKNOWLEDGES THAT THE BUYER OR USER ALONE HAS DETERMINED THAT THE PRODUCTS WILL SUITABLY MEET THE REQUIREMENTS OF THEIR INTENDED USE. OMRON DISCLAIMS ALL OTHER WARRANTIES, EXPRESS OR IMPLIED.

LIMITATIONS OF LIABILITY

OMRON SHALL NOT BE RESPONSIBLE FOR SPECIAL, INDIRECT, OR CONSEQUENTIAL DAMAGES, LOSS OF PROFITS OR COMMERCIAL LOSS IN ANY WAY CONNECTED WITH THE PRODUCTS, WHETHER SUCH CLAIM IS BASED ON CONTRACT, WARRANTY, NEGLIGENCE, OR STRICT LIABILITY.

In no event shall responsibility of OMRON for any act exceed the individual price of the product on which liability is asserted.

IN NO EVENT SHALL OMRON BE RESPONSIBLE FOR WARRANTY, REPAIR, OR OTHER CLAIMS REGARDING THE PRODUCTS UNLESS OMRON'S ANALYSIS CONFIRMS THAT THE PRODUCTS WERE PROPERLY HANDLED, STORED, INSTALLED, AND MAINTAINED AND NOT SUBJECT TO CONTAMINATION, ABUSE, MISUSE, OR INAPPROPRIATE MODIFICATION OR REPAIR.

SUITABILITY FOR USE

THE PRODUCTS CONTAINED IN THIS DOCUMENT ARE NOT SAFETY RATED. THEY ARE NOT DESIGNED OR RATED FOR ENSURING SAFETY OF PERSONS, AND SHOULD NOT BE RELIED UPON AS A SAFETY COMPONENT OR PROTECTIVE DEVICE FOR SUCH PURPOSES. Please refer to separate catalogs for OMRON's safety rated products.

OMRON shall not be responsible for conformity with any standards, codes, or regulations that apply to the combination of products in the customer's application or use of the product.

At the customer's request, OMRON will provide applicable third party certification documents identifying ratings and limitations of use that apply to the products. This information by itself is not sufficient for a complete determination of the suitability of the products in combination with the end product, machine, system, or other application or use.

The following are some examples of applications for which particular attention must be given. This is not intended to be an exhaustive list of all possible uses of the products, nor is it intended to imply that the uses listed may be suitable for the products:

- Outdoor use, uses involving potential chemical contamination or electrical interference, or conditions or uses not described in this document.
- Nuclear energy control systems, combustion systems, railroad systems, aviation systems, medical equipment, amusement machines, vehicles, safety equipment, and installations subject to separate industry or government regulations.
- Systems, machines, and equipment that could present a risk to life or property.

Please know and observe all prohibitions of use applicable to the products.

NEVER USE THE PRODUCTS FOR AN APPLICATION INVOLVING SERIOUS RISK TO LIFE OR PROPERTY WITHOUT ENSURING THAT THE SYSTEM AS A WHOLE HAS BEEN DESIGNED TO ADDRESS THE RISKS, AND THAT THE OMRON PRODUCT IS PROPERLY RATED AND INSTALLED FOR THE INTENDED USE WITHIN THE OVERALL EQUIPMENT OR SYSTEM.

PERFORMANCE DATA

Performance data given in this document is provided as a guide for the user in determining suitability and does not constitute a warranty. It may represent the result of OMRON's test conditions, and the users must correlate it to actual application requirements. Actual performance is subject to the OMRON Warranty and Limitations of Liability.

CHANGE IN SPECIFICATIONS

Product specifications and accessories may be changed at any time based on improvements and other reasons.

It is our practice to change model numbers when published ratings or features are changed, or when significant construction changes are made. However, some specifications of the product may be changed without any notice. When in doubt, special model numbers may be assigned to fix or establish key specifications for your application on your request. Please consult with your OMRON representative at any time to confirm actual specifications of purchased products.

DIMENSIONS AND WEIGHTS

Dimensions and weights are nominal and are not to be used for manufacturing purposes, even when tolerances are shown.

ERRORS AND OMISSIONS

The information in this document has been carefully checked and is believed to be accurate; however, no responsibility is assumed for clerical, typographical, or proofreading errors, or omissions.

PROGRAMMABLE PRODUCTS

OMRON shall not be responsible for the user's programming of a programmable product, or any consequence thereof.

COPYRIGHT AND COPY PERMISSION

This document shall not be copied for sales or promotions without permission.

This document is protected by copyright and is intended solely for use in conjunction with the product. Please notify us before copying or reproducing this document in any manner, for any other purpose. If copying or transmitting this document to another, please copy or transmit it in its entirety.

A Wide Range of Information Support Tools for Production Lines

Handheld Types



Installed Types



ZR-MDR10 Mobile Data Recorder

The ZR-MDR10 connects to a ZS Smart Sensor via a USB host interface. It lets the operator easily make optimal sensor settings while checking production and sensing conditions on the mobile screen.

ZP-C Graphic Data Controller

The ZP-C Graphic Data Controller is ideal for connecting to an analog output device such as a ZS-series Displacement Sensor. Touch-panel operation allows the operator to instantly calculate and compare the resulting input signals, and to display them in a numerical or graphic format.

This document provides information mainly for selecting suitable models. Please read the manual carefully for information that the user must understand and accept before purchase, including information on warranty, limitations of liability, and precautions.

OMRON Corporation Industrial Automation Company Sensing Devices Division H.Q.

Application Sensors Division
Shiokoji Horikawa, Shimogyo-ku,
Kyoto, 600-8530 Japan
Tel: (81) 75-344-7068/Fax: (81) 75-344-7107

Regional Headquarters

OMRON EUROPE B.V.
Sensor Business Unit
Carl-Benz-Str. 4, D-71154 Nufringen,
Germany
Tel: (49) 7032-811-0/Fax: (49) 7032-811-199

OMRON ELECTRONICS LLC

One Commerce Drive Schaumburg,
IL 60173-5302 U.S.A.
Tel: (1) 847-843-7900/Fax: (1) 847-843-7787

OMRON ASIA PACIFIC PTE. LTD.

No. 438A Alexandra Road # 05-05/08 (Lobby 2),
Alexandra Technopark, Singapore 119967
Tel: (65) 6835-3011/Fax: (65) 6835-2711

OMRON (CHINA) CO., LTD.

Room 2211, Bank of China Tower,
200 Yin Cheng Zhong Road,
PuDong New Area, Shanghai, 200120, China
Tel: (86) 21-5037-2222/Fax: (86) 21-5037-2200

Authorized Distributor:

In the interest of product improvement,
specifications are subject to change without notice.

CSM_1_3_0811
Cat. No. E375-E1-02

Printed in Japan



Компания «ЭлектроПласт» предлагает заключение долгосрочных отношений при поставках импортных электронных компонентов на взаимовыгодных условиях!

Наши преимущества:

- Оперативные поставки широкого спектра электронных компонентов отечественного и импортного производства напрямую от производителей и с крупнейших мировых складов;
- Поставка более 17-ти миллионов наименований электронных компонентов;
- Поставка сложных, дефицитных, либо снятых с производства позиций;
- Оперативные сроки поставки под заказ (от 5 рабочих дней);
- Экспресс доставка в любую точку России;
- Техническая поддержка проекта, помощь в подборе аналогов, поставка прототипов;
- Система менеджмента качества сертифицирована по Международному стандарту ISO 9001;
- Лицензия ФСБ на осуществление работ с использованием сведений, составляющих государственную тайну;
- Поставка специализированных компонентов (Xilinx, Altera, Analog Devices, Intersil, Interpoint, Microsemi, Aeroflex, Peregrine, Syfer, Eurofarad, Texas Instrument, Miteq, Cobham, E2V, MA-COM, Hittite, Mini-Circuits, General Dynamics и др.);

Помимо этого, одним из направлений компании «ЭлектроПласт» является направление «Источники питания». Мы предлагаем Вам помощь Конструкторского отдела:

- Подбор оптимального решения, техническое обоснование при выборе компонента;
- Подбор аналогов;
- Консультации по применению компонента;
- Поставка образцов и прототипов;
- Техническая поддержка проекта;
- Защита от снятия компонента с производства.



Как с нами связаться

Телефон: 8 (812) 309 58 32 (многоканальный)

Факс: 8 (812) 320-02-42

Электронная почта: org@eplast1.ru

Адрес: 198099, г. Санкт-Петербург, ул. Калинина, дом 2, корпус 4, литера А.