

CMPA5259025F

25 W, 5200 - 5900 MHz, 28 V, GaN MMIC for Radar Power Amplifiers

Cree's CMPA5259025F is a gallium nitride (GaN) High Electron Mobility Transistor (HEMT) based monolithic microwave integrated circuit (MMIC) designed specifically for high efficiency, high gain, and wide bandwidth capabilities, which makes CMPA5259025F ideal for 5.2 - 5.9 GHz Radar amplifier applications. The transistor is supplied in a ceramic/metal flange package.

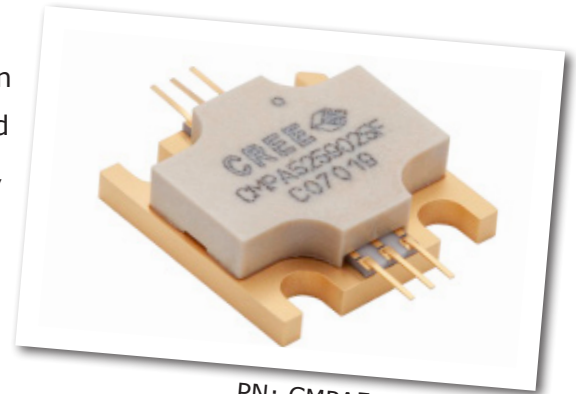

PN: CMPA5259025F
Package Type: 440219

Typical Performance Over 5.2-5.9 GHz ($T_c = 25^\circ\text{C}$) of Demonstration Amplifier

Parameter	5.2 GHz	5.5 GHz	5.9 GHz	Units
Small Signal Gain	33.6	31.9	32.2	dB
Output Power	38.5	39.6	34.8	W
Efficiency	53.5	51.3	47.2	%
Input Return Loss	-13.5	-15.5	-4.8	dB

Note:
100 μsec Pulse Width, 10% Duty Cycle, $P_{in} = 22\text{ dBm}$

Features

- 30 dB Small Signal Gain
- 50% Efficiency at P_{SAT}
- Operation up to 28 V
- High Breakdown Voltage

Applications

- Radar



Absolute Maximum Ratings (not simultaneous) at 25°C Case Temperature

Parameter	Symbol	Rating	Units	Conditions
Drain-source Voltage	V_{DSS}	84	V_{DC}	25°C
Gate-source Voltage	V_{GS}	-10, +2	V_{DC}	25°C
Storage Temperature	T_{STG}	-55, +150	°C	
Operating Junction Temperature	T_J	225	°C	
Soldering Temperature	T_S	245	°C	
Screw Torque	τ	60	in-oz	
Forward Gate Current	I_G	8	mA	25°C
Thermal Resistance, Junction to Case ¹	$R_{\theta JC}$	1.66	°C/W	100 usec, 10%, 85°C
Case Operating Temperature	T_C	-40, +105	°C	

Notes:

¹ Measured for the CMPA5259025F at $P_{DSS} = 35$ W.

Electrostatic Discharge (ESD) Classifications

Parameter	Symbol	Class	Test Methodology
Human Body Model	HBM	1A (> 250 V)	JEDEC JESD22 A114-D
Charge Device Model	CDM	2 (125 V to 250 V)	JEDEC JESD22 C101-C

Electrical Characteristics (T_c = 25 °C)

Characteristics	Symbol	Min.	Typ.	Max.	Units	Conditions
DC Characteristics¹						
Gate Threshold Voltage	V _{GS(th)}	-3.0	-2.5	-	V _{DC}	V _{DS} = 10 V, I _{DS} = 500 mA
Gate Quiescent Voltage	V _{GS(Q)}	-	-2.7	-	V _{DC}	V _{DS} = 10 V, I _D = 500 mA
Saturated Drain Current	I _{DS}	16.4	18.6	-	A	V _{DS} = 6 V, V _{GS} = 2 V
Drain-Source Breakdown Voltage	V _{BD}	84	100	-	V _{DC}	V _{GS} = -8 V, I _{DS} = 500 mA
RF Characteristics²						
Small Signal Gain ₁	G _{SS}	-	32	-	dB	V _{DD} = 28 V, I _{DQ} = 500 mA, Freq = 5.2 GHz, P _{IN} = -20 dBm
Small Signal Gain ₂	G _{SS}	-	32	-	dB	V _{DD} = 28 V, I _{DQ} = 500 mA, Freq = 5.5 GHz, P _{IN} = -20 dBm
Small Signal Gain ₃	G _{SS}	-	32	-	dB	V _{DD} = 28 V, I _{DQ} = 500 mA, Freq = 5.9 GHz, P _{IN} = -20 dBm
Power Output ₁	P _{OUT}	-	38.5	-	W	V _{DD} = 28 V, I _{DQ} = 500 mA, Freq = 5.2 GHz, P _{IN} = 22 dBm
Power Output ₂	P _{OUT}	-	39.6	-	W	V _{DD} = 28 V, I _{DQ} = 500 mA, Freq = 5.5 GHz, P _{IN} = 22 dBm
Power Output ₃	P _{OUT}	-	34.8	-	W	V _{DD} = 28 V, I _{DQ} = 500 mA, Freq = 5.9 GHz, P _{IN} = 22 dBm
Power Added Efficiency ₁	PAE	-	54	-	%	V _{DD} = 28 V, I _{DQ} = 500 mA, Freq = 5.2 GHz, P _{IN} = 22 dBm
Power Added Efficiency ₂	PAE	-	51	-	%	V _{DD} = 28 V, I _{DQ} = 500 mA, Freq = 5.5 GHz, P _{IN} = 22 dBm
Power Added Efficiency ₃	PAE	-	47	-	%	V _{DD} = 28 V, I _{DQ} = 500 mA, Freq = 5.9 GHz, P _{IN} = 22 dBm
Power Gain ₁	G _p	-	24	-	dB	V _{DD} = 28 V, I _{DQ} = 500 mA, Freq = 5.2 GHz, P _{IN} = 22 dBm
Power Gain ₂	G _p	-	24	-	dB	V _{DD} = 28 V, I _{DQ} = 500 mA, Freq = 5.5 GHz, P _{IN} = 22 dBm
Power Gain ₃	G _p	-	23.4	-	dB	V _{DD} = 28 V, I _{DQ} = 500 mA, Freq = 5.9 GHz, P _{IN} = 22 dBm
Input Return Loss	S11	-	-10	-	dB	V _{DD} = 28 V, I _{DQ} = 500 mA, Freq = 5.2 - 5.9 GHz, P _{IN} = -20 dBm
Output Return Loss	S22	-	-15	-	dB	V _{DD} = 28 V, I _{DQ} = 500 mA, Freq = 5.2 - 5.9 GHz, P _{IN} = -20 dBm
Output Mismatch Stress	VSWR	-	3:1	-	Ψ	No damage at all phase angles, V _{DD} = 28 V, I _{DQ} = 500 mA, P _{IN} = 22 dBm

Notes:

¹ Measured on wafer prior to packaging.

² Measured in CMPA5259025F-TB test fixture.

³ Drain Efficiency = P_{OUT}/P_{DC}

Typical Pulsed Performance of the CMPA5259025F

Figure 1. - Gain and Input Return Loss vs. Frequency of the CMPA5259025F Measured in CMPA5259025F-AMP Amplifier Circuit
 $V_{DD} = 28\text{ V}$, $I_{DQ} = 0.5\text{ A}$, $T_c = 25^\circ\text{C}$

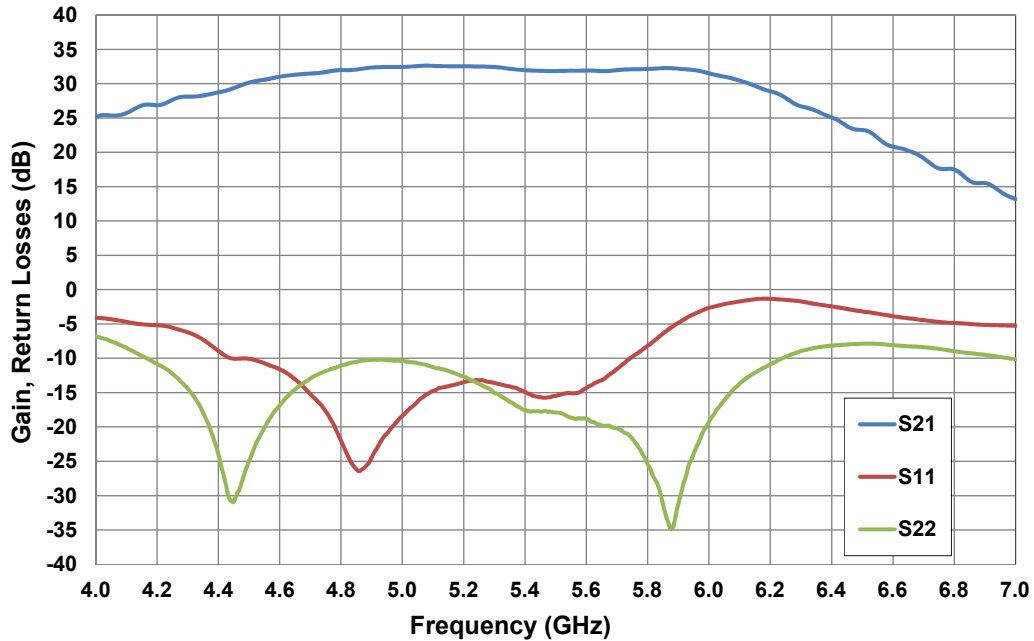
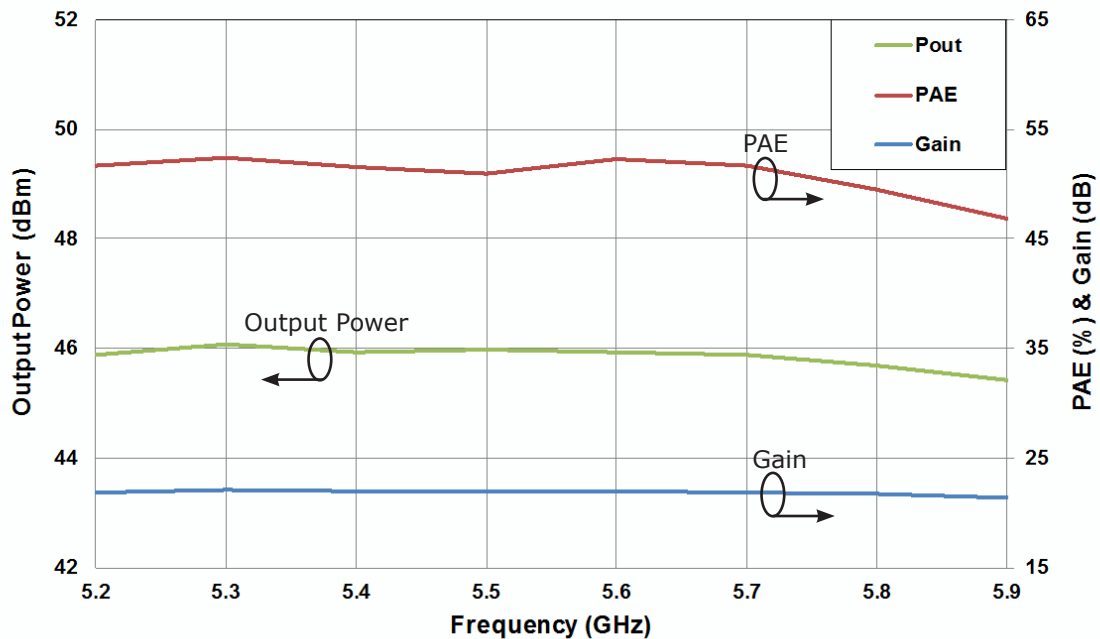

Figure 2. - Output Power, Gain, and Power Added Efficiency vs. Frequency of the CMPA5259025F Measured in CMPA5259025F-AMP Amplifier Circuit
 $V_{DD} = 28\text{ V}$, $I_{DQ} = 0.5\text{ A}$, $P_{IN} = 24\text{ dBm}$, Pulse Width = $100\ \mu\text{s}$,
 Duty Cycle = 10%, $T_c = 25^\circ\text{C}$



Typical Pulsed Performance of the CMPA5259025F

**Figure 3. - Gain and Power Added Efficiency vs. Frequency of the CMPA529025F
Measured in CMPA525025F-AMP Amplifier Circuit**

$V_{DD} = 28\text{ V}$, $I_{DQ} = 0.5\text{ A}$, Pulse Width = 100 μs , Duty Cycle = 10%, $T_C = 25^\circ\text{C}$

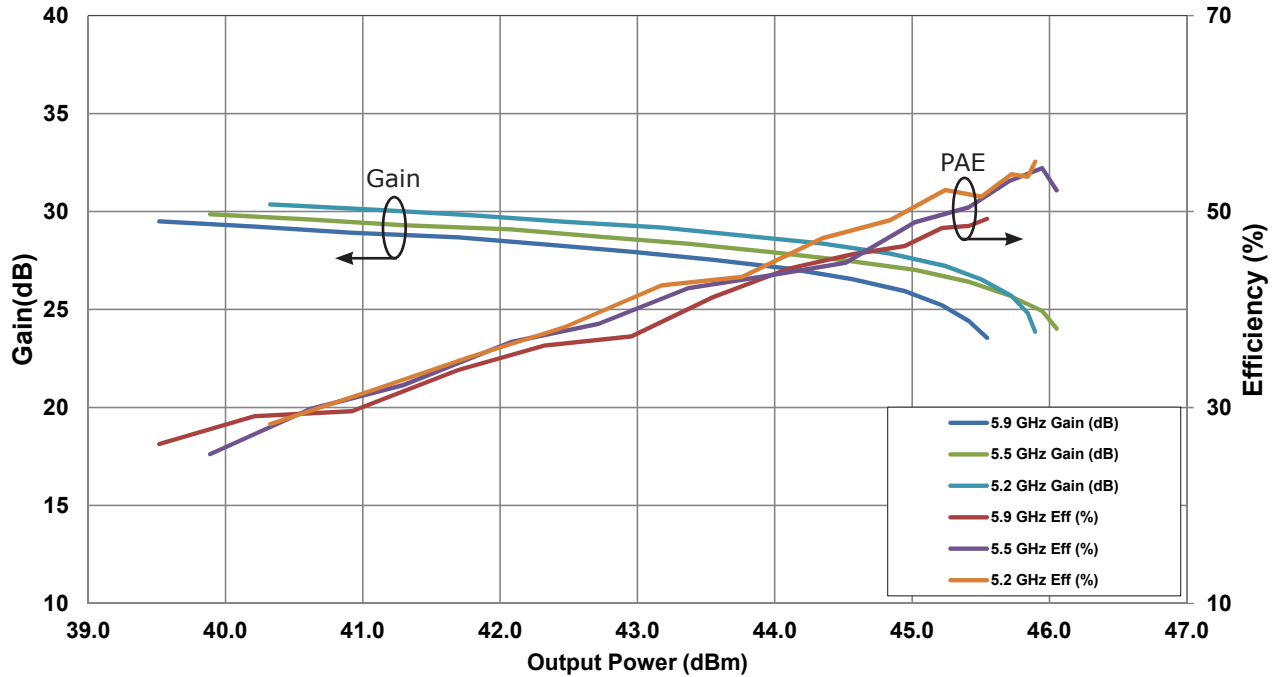

CMPA5259025F-TB Demonstration Amplifier Schematic

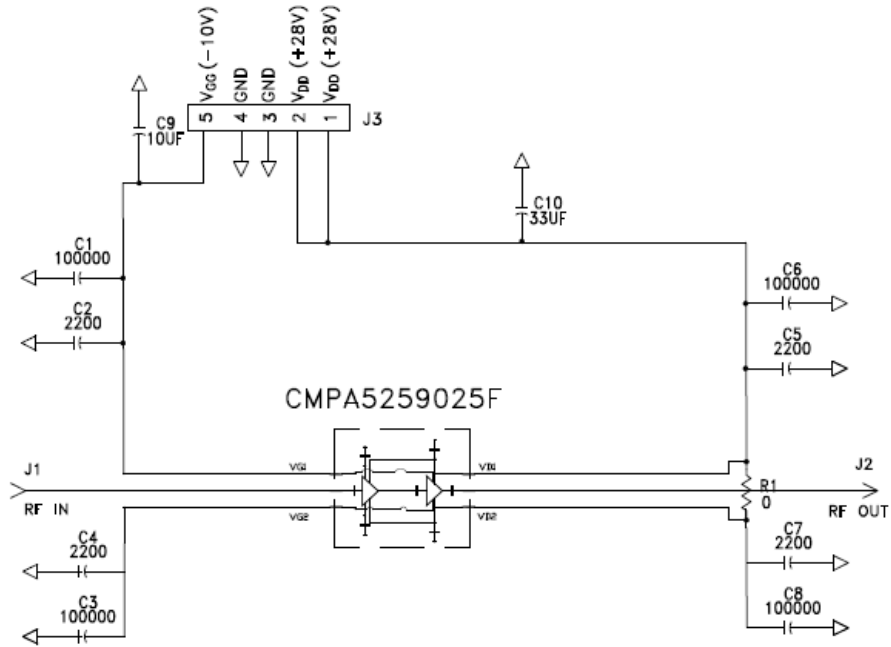

CMPA5259025F-TB Demonstration Amplifier Circuit Outline

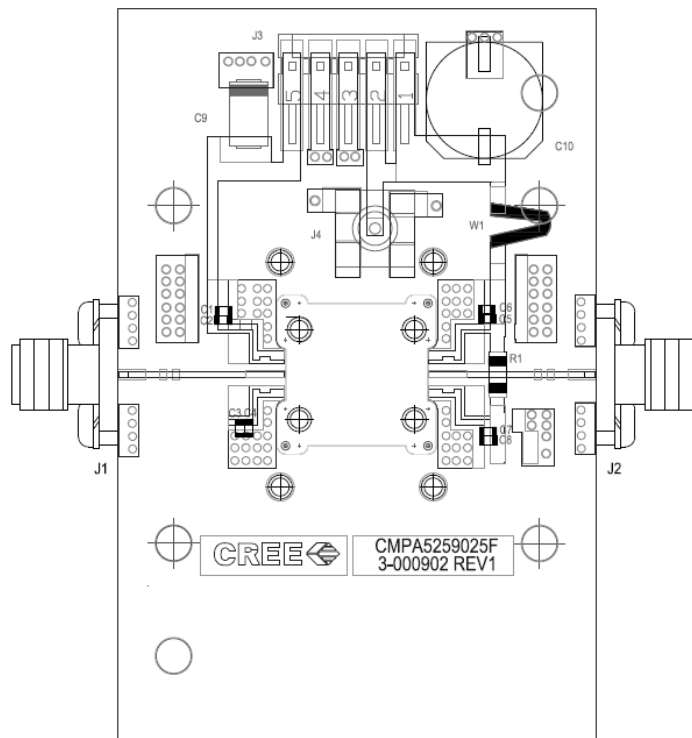

CMPA5259025F-TB Demonstration Amplifier Circuit Bill of Materials

Designator	Description	Qty
R1	RES 0 OHM, SMT, 1206, 125 mW	1
C1, C3, C6, C8	CAP, 100000 pF, (0.1 UF) +/- 10%, 100 V, 0805	4
C2, C4, C5, C7	CAP, 0805, 2200 pF, 100 V, 0805	4
C9	CAP, 10 UF, 16 V, Tantalum	1
C10	CAP, 33 UF, 20%, G Case	1
J3	Header RT> PLZ .1 CEN LK 5POS	1
J1, J2	CONN, SMA, Female, 2-Hole, Flange	2
J4	CONN, SMB, Straight Jack Receptacle, SMT, 50 OHM, Au Plated	1
	Baseplate, AL, 2.60 X 1.7 X 0.25	1
	#4 Split Lockwasher SS	4
	2-56 SoC HD Screw 3/16 SS	4
	#2 Split Lockwasher SS	4
	4-40 SOC HD Screw 3/8" SS	4
	PCB, Taconics, RF 35, CMPA5259025F 0.010" THK	1
W1	Wire, Black, 22 AWG ~ 3"	

CMPA5259025F-TB Demonstration Amplifier Circuit

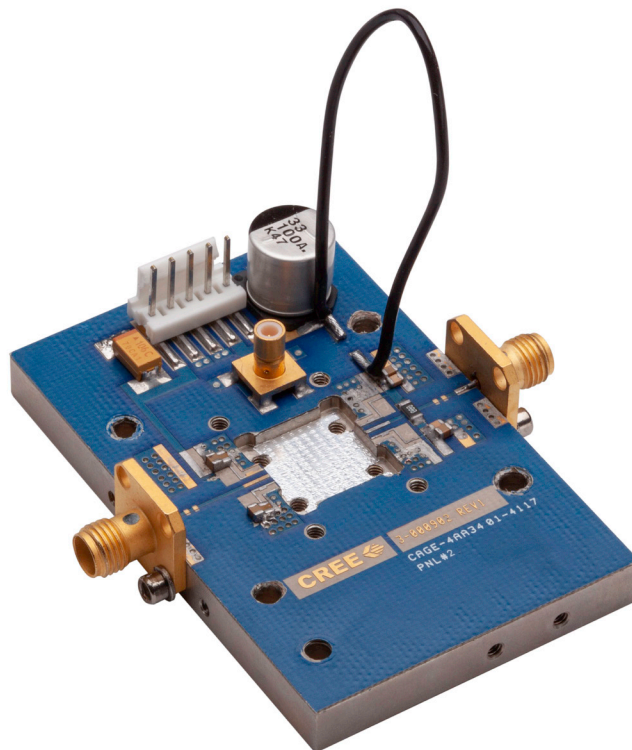

Product Dimensions CMPA5259025F (Package Type — 440219)

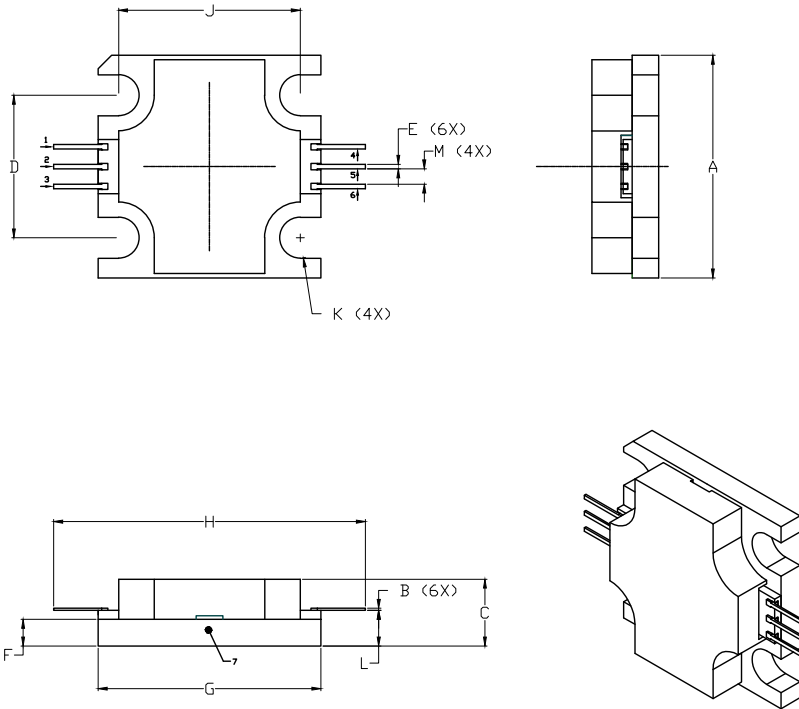

NOT TO SCALE

NOTES:

1. DIMENSIONING AND TOLERANCING PER ANSI Y14.5M, 1982.
2. CONTROLLING DIMENSION: INCH.
3. ADHESIVE FROM LID MAY EXTEND A MAXIMUM OF 0.020" BEYOND EDGE OF LID.
4. LID MAY BE MISALIGNED TO THE BODY OF THE PACKAGE BY A MAXIMUM OF 0.008" IN ANY DIRECTION.
5. ALL PLATED SURFACES ARE NI/AU

DIM	INCHES		MILLIMETERS	
	MIN	MAX	MIN	MAX
A	0.495	0.505	12.57	12.82
B	0.003	0.005	0.076	0.127
C	0.140	0.160	3.56	4.06
D	0.315	0.325	8.00	8.25
E	0.008	0.012	0.204	0.304
F	0.055	0.065	1.40	1.65
G	0.495	0.505	12.57	12.82
H	0.695	0.705	17.65	17.91
J	0.403	0.413	10.24	10.49
K	∅ .092		2.34	
L	0.075	0.085	1.905	2.159
M	0.032	0.040	0.82	1.02

PIN	
1	Gate bias
2	RF _{IN}
3	Gate bias
4	Drain bias
5	RF _{OUT}
6	Drain bias
7	Source

CMPA5259025F

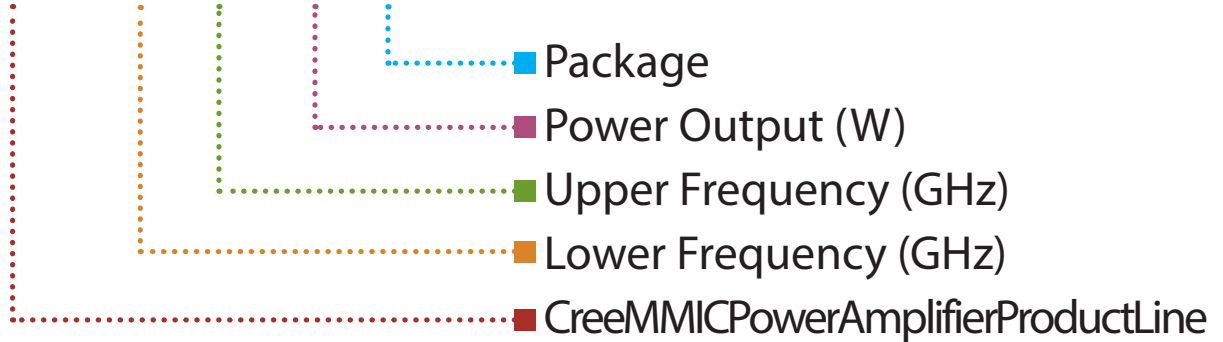

Parameter	Value	Units
Lower Frequency	5.2	GHz
Upper Frequency ¹	5.9	GHz
Power Output	25	W
Package	Flange	-

Table 1.

Note¹: Alpha characters used in frequency code indicate a value greater than 9.9 GHz. See Table 2 for value.

Character Code	Code Value
A	0
B	1
C	2
D	3
E	4
F	5
G	6
H	7
J	8
K	9
Examples:	1A = 10.0 GHz 2H = 27.0 GHz

Table 2.

Product Ordering Information

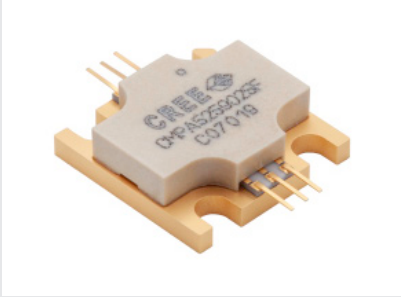
Order Number	Description	Unit of Measure	Image
CMPA5259025F	GaN MMIC	Each	
CMPA5259025F-AMP	Test board with GaN MMIC installed	Each	



Disclaimer

Specifications are subject to change without notice. Cree, Inc. believes the information contained within this data sheet to be accurate and reliable. However, no responsibility is assumed by Cree for its use or for any infringement of patents or other rights of third parties which may result from its use. No license is granted by implication or otherwise under any patent or patent rights of Cree. Cree makes no warranty, representation or guarantee regarding the suitability of its products for any particular purpose. "Typical" parameters are the average values expected by Cree in large quantities and are provided for information purposes only. These values can and do vary in different applications, and actual performance can vary over time. All operating parameters should be validated by customer's technical experts for each application. Cree products are not designed, intended, or authorized for use as components in applications intended for surgical implant into the body or to support or sustain life, in applications in which the failure of the Cree product could result in personal injury or death, or in applications for the planning, construction, maintenance or direct operation of a nuclear facility. CREE and the CREE logo are registered trademarks of Cree, Inc.

For more information, please contact:

Cree, Inc.
4600 Silicon Drive
Durham, North Carolina, USA 27703
www.cree.com/RF

Sarah Miller
Marketing
Cree, RF Components
1.919.407.5302

Ryan Baker
Marketing & Sales
Cree, RF Components
1.919.407.7816

Tom Dekker
Sales Director
Cree, RF Components
1.919.407.5639



Компания «ЭлектроПласт» предлагает заключение долгосрочных отношений при поставках импортных электронных компонентов на взаимовыгодных условиях!

Наши преимущества:

- Оперативные поставки широкого спектра электронных компонентов отечественного и импортного производства напрямую от производителей и с крупнейших мировых складов;
- Поставка более 17-ти миллионов наименований электронных компонентов;
- Поставка сложных, дефицитных, либо снятых с производства позиций;
- Оперативные сроки поставки под заказ (от 5 рабочих дней);
- Экспресс доставка в любую точку России;
- Техническая поддержка проекта, помощь в подборе аналогов, поставка прототипов;
- Система менеджмента качества сертифицирована по Международному стандарту ISO 9001;
- Лицензия ФСБ на осуществление работ с использованием сведений, составляющих государственную тайну;
- Поставка специализированных компонентов (Xilinx, Altera, Analog Devices, Intersil, Interpoint, Microsemi, Aeroflex, Peregrine, Syfer, Eurofarad, Texas Instrument, Miteq, Cobham, E2V, MA-COM, Hittite, Mini-Circuits, General Dynamics и др.);

Помимо этого, одним из направлений компании «ЭлектроПласт» является направление «Источники питания». Мы предлагаем Вам помощь Конструкторского отдела:

- Подбор оптимального решения, техническое обоснование при выборе компонента;
- Подбор аналогов;
- Консультации по применению компонента;
- Поставка образцов и прототипов;
- Техническая поддержка проекта;
- Защита от снятия компонента с производства.



Как с нами связаться

Телефон: 8 (812) 309 58 32 (многоканальный)

Факс: 8 (812) 320-02-42

Электронная почта: org@eplast1.ru

Адрес: 198099, г. Санкт-Петербург, ул. Калинина, дом 2, корпус 4, литера А.