

GHA300F

GH A 300 F -□□ -□
 ① ② ③ ④ ⑤ ⑥



Recommended EMI/EMC Filter
EAC-10-472



High voltage pulse noise type : EAP series
 Low leakage current type : EAM series
 *The EMI/EMC Filter is recommended to connect with several devices.

- ① Series name
 - ② Single output
 - ③ Output wattage
 - ④ Universal input
 - ⑤ Output voltage
 - ⑥ Optional *6
 - T3 : mounting hole M3
 - J1 : VH(J.S.T.)connector type
 - R3 : with Subfeatures (5VAUX,12VAUX,Remote, Power good)
- Specification is changed at option, refer to Instruction manual.

This power supply is manufactured by SMD technology. The stress to P.C.B like twisting or bending causes the defect of the unit, please handle the unit with care

MODEL	GHA300F-12		GHA300F-24		GHA300F-48	
MAX OUTPUT WATTAGE[W]	300		300		302.4	
DC OUTPUT	Forced air	at 50°C	12V 25A	24V 12.5A	48V 6.3A	
		at 40°C	12V 8.4A	24V 4.2A	48V 2.1A	
	Convection	at 50°C	12V 4.5A	24V 2.2A	48V 1.1A	

SPECIFICATIONS

	MODEL	GHA300F-12	GHA300F-24	GHA300F-48	
INPUT	VOLTAGE[V]	AC90 - 264 1 φ (output derating is required at AC90V -115V *3)			
	CURRENT[A]	ACIN 120V	3.3typ		
		ACIN 230V	1.8typ		
	FREQUENCY[Hz]	50 / 60 (47 - 63)			
	EFFICIENCY[%]	ACIN 120V	89typ	90typ	90typ
		ACIN 230V	91typ	92typ	92typ
	POWER FACTOR (lo=100%)	ACIN 120V	0.95typ		
		ACIN 230V	0.90typ		
INRUSH CURRENT[A]	ACIN 120V	20typ (lo=100%) (At cold start) (Ta=25°C)			
	ACIN 230V	40typ (lo=100%) (At cold start) (Ta=25°C)			
LEAKAGE CURRENT[mA]	0.125/0.250max (ACIN 120V/240V 60Hz,lo=100%, According to IEC60601-1)				
OUTPUT	VOLTAGE[V]	12	24	48	
	CURRENT[A]	Forced air	25	12.5	6.3
		Convection	4.5	2.2	1.1
	LINE REGULATION[mV] *4	48max	96max	192max	
	LOAD REGULATION[mV] *4	100max	150max	240max	
	RIPPLE[mVp-p] *1	0 to +50°C	240max	240max	300max
		-20 to 0°C	320max	320max	400max
	RIPPLE NOISE[mVp-p]*1	0 to +50°C	300max	300max	480max
		-20 to 0°C	360max	360max	500max
	TEMPERATURE REGULATION[mV]	0 to +50°C	120max	240max	480max
		-20 to +50°C	150max	290max	600max
	DRIFT[mV] *2	48max	96max	192max	
	START-UP TIME[ms]	500typ (ACIN 120V, lo=100%)			
	HOLD-UP TIME[ms]	16typ (ACIN 120V, lo=100%)			
OUTPUT VOLTAGE ADJUSTMENT RANGE[V]	10.80 to 13.20		21.60 to 26.40	43.20 to 52.80	
OUTPUT VOLTAGE SETTING[V]	12.00 to 12.48		24.00 to 24.96	48.00 to 49.92	
PROTECTION CIRCUIT AND OTHERS	OVERCURRENT PROTECTION	Works over 105% of rating and recovers automatically			
	OVERVOLTAGE PROTECTION[V]	13.80 to 16.80	27.60 to 33.60	55.20 to 67.20	
	AUX1 (12V1A)	Optional			
	AUX2 (5V1A)	Optional			
	REMOTE ON/OFF PowerGood	Optional			
ISOLATION	INPUT-OUTPUT · RC · AUX *7	AC4,000V 1minute, Cutoff current = 10mA, DC500V 50MΩ min (At Room Temperature)			
	INPUT-FG	AC2,000V 1minute, Cutoff current = 10mA, DC500V 50MΩ min (At Room Temperature)			
	OUTPUT · RC · AUX-FG *7	AC500V 1minute, Cutoff current = 25mA, DC500V 50MΩ min (At Room Temperature)			
	OUTPUT-RC · AUX *7	AC500V 1minute, Cutoff current = 25mA, DC500V 50MΩ min (At Room Temperature)			
ENVIRONMENT	OPERATING TEMP.,HUMID.AND ALTITUDE	-20 to +70°C, 20 - 90%RH (Non condensing), 3,000m (10,000feet) max			
	STORAGE TEMP.,HUMID.AND ALTITUDE	-30 to +75°C, 20 - 90%RH (Non condensing), 9,000m (30,000feet) max			
	VIBRATION	10 - 55Hz, 19.6m/s ² (2G), 3minutes period, 60minutes each along X, Y and Z axis			
	IMPACT	196.1m/s ² (20G), 11ms, once each X, Y and Z axis			
SAFETY AND NOISE REGULATIONS	AGENCY APPROVALS	UL60950-1, ANSI/AAMI ES60601-1, C-UL(CSA60950-1, CAN/CSA60601-1), EN60950-1, EN60601-1 3rd			
	CONDUCTED NOISE	Complies with FCC-B, VCCI-B, CISPR11-B, CISPR22-B, EN55011-B, EN55022-B			
	HARMONIC ATTENUATOR	Complies with IEC61000-3-2 (class A) *5			
OTHERS	CASE SIZE/WEIGHT	76.2 X 35 X 127mm [3.0 X 1.4 X 5.0 inches] (W X H X D) / 400g max			
	COOLING METHOD	Convection, Forced air (Require external fan)			

*1 This is the value that measured on measuring board with capacitor of 22 μF at 150mm from output terminal.
 Measured by 20MHz oscilloscope or Ripple-Noise meter (Equivalent to KEISOKU-GIKEN: RM103).
 *2 Drift is the change in DC output for an eight hour period after a half-hour warm-up at 25°C, with the input voltage held constant at the rated input/output.
 *3 Derating is required.
 *4 Please contact us about dynamic load and input response.
 *5 Please contact us about another class.

*6 Specification is changed at option, refer to Instruction Manual.
 *7 Applicable when AUX and remote control (optional) is added.
 * To meet the specifications. Do not operate over-loaded condition.
 * Sound noise may be generated by power supply in case of pulse load.
 * Parallel operation is not possible.
 * Forced air cooling is required to output up to MAX OUTPUT WATTAGE.
 * Bottom layer P.C.B has electric potential which is required isolation from FG by clearance or creepage as the safety design issue.

Features

- High Power density: 14.3W/inch³
- High efficiency 92% typ (Input Voltage 230V, Output Voltage 24V)
- 3" × 5" standard footprint
- Fits 1U applications
- Industrial and Medical safety approvals
- Low leakage current
- With Remote On/Off (Optional)
- With AUX1 (5V), AUX2 (12V) (Optional)
- No minimum load is required

Block diagram



External view

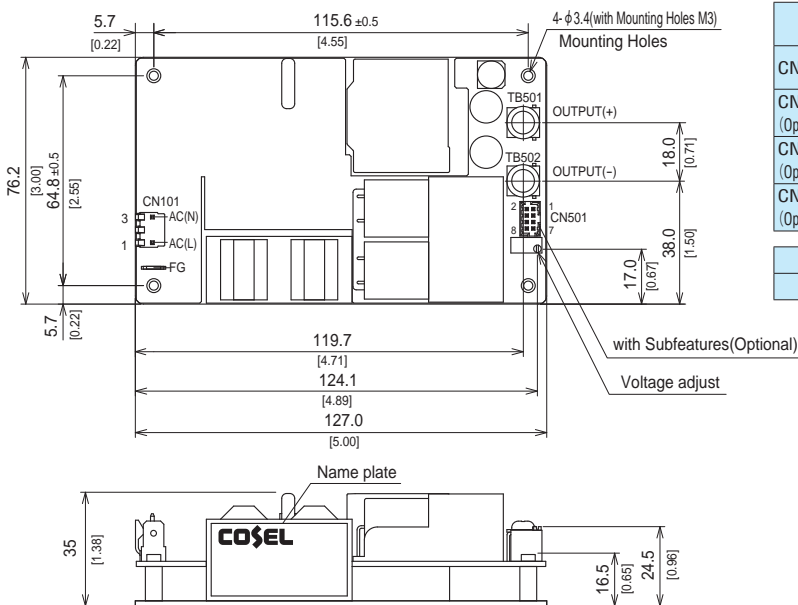

I/O Connector	Mating connector	Terminal	Mfr
CN101	A-41671-A03A197-2	08-50-0105 08-65-0114	MOLEX
CN501 (Optional)	087831-0820	51110-0851 50394-8051	
CN101 (Optional)	B2P3-VH	VHR-3N SVH-21T-P1.1	J.S.T.
CN501 (Optional)	B8B-PHDSS	PHDR-08VS SPHD-002T-P0.5	

FG	Mating connector	Terminal	Mfr
-	250 Series	170603-2	Tyco Electronics

<Pin Assignments>

<CN101>

Pin No.	Input
1	AC(L)
2	
3	AC(N)

<CN501(Optional)>

Pin No.	Function
1	AUX1 : AUX1 (12V1A)
2	AUX1G: AUX1 (GND)
3	RC : REMOTE ON/OFF
4	RCG : REMOTE ON/OFF (GND)
5	PG : Power good
6	PGG : Power good (GND)
7	AUX2 : AUX2 (5V1A)
8	AUX2G: AUX2 (GND)



CN501

- ※ Tolerance ± 1 [± 0.04]
- ※ Weight : 400g max
- ※ There is a total of four attachment holes.
- ※ This power supply requires mounting on metal standoffs 5mm in height. (Insulating sheet is required if you do not use a spacer).
- ※ Dimensions in mm, []=inches
- ※ Screw tightening torque : (TB501, 502) : 1.5N · m max
- ※ Mounting torque : 0.6N · m max
- ※ Avoid contact between TB501 and 502 wiring with mounting parts.
- ※ Option : -J1 : (J.S.T) connector type. Refer to Instruction Manual 5.

GHA500F

GH A 500 F -□□ -□
 ① ② ③ ④ ⑤ ⑥

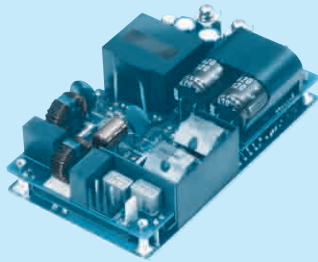

Recommended EMI/EMC Filter
EAC-10-472



High voltage pulse noise type : EAP series
 Low leakage current type : EAM series
 *The EMI/EMC Filter is recommended to connect with several devices.

- ① Series name
 - ② Single output
 - ③ Output wattage
 - ④ Universal input
 - ⑤ Output voltage
 - ⑥ Optional *6
 - T3 : mounting hole M3
 - J1 : VH(J.S.T.)connector type
 - R3 : with Subfeatures (5VAUX,12VAUX,Remote, Power good)
 - P : Pallarel Operation
- Specification is changed at option, refer to Instruction manual.

This power supply is manufactured by SMD technology. The stress to P.C.B like twisting or bending causes the defect of the unit, please handle the unit with care

MODEL	GHA500F-12	GHA500F-15	GHA500F-24	GHA500F-30	GHA500F-48	GHA500F-56	
MAX OUTPUT WATTAGE[W]	500.8	501	504	501	504	504	
DC OUTPUT	Forced air	at 50°C	12V 41.7A	15V 33.4A	24V 21.0A	30V 16.7A	48V 10.5A
		at 40°C	12V 12.5A	15V 10.0A	24V 6.3A	30V 5.0A	48V 3.2A
	Convection	at 50°C	12V 9.2A	15V 7.4A	24V 4.6A	30V 3.7A	48V 2.3A
		at 0°C	12V 30.0A	15V 24.0A	24V 15.0A	30V 12.0A	48V 7.5A
	conduction cooling	at 0°C	12V 30.0A	15V 24.0A	24V 15.0A	30V 12.0A	48V 7.5A
		at 50°C	12V 16.7A	15V 13.4A	24V 8.4A	30V 6.7A	48V 4.2A

SPECIFICATIONS

	MODEL	GHA500F-12	GHA500F-15	GHA500F-24	GHA500F-30	GHA500F-48	GHA500F-56	
INPUT	VOLTAGE[V]	AC90 - 264 1 φ (output derating is required at AC90V -115V *3)						
	CURRENT[A]	ACIN 120V	5.4typ					
		ACIN 230V	2.9typ					
	FREQUENCY[Hz]	50 / 60 (47 - 63)						
	EFFICIENCY[%]	ACIN 120V	88typ	90typ	90typ	90typ	90typ	90typ
		ACIN 230V	90typ	92typ	92typ	92typ	92typ	92typ
	POWER FACTOR (Io=100%)	ACIN 120V	0.95typ					
		ACIN 230V	0.90typ					
	INRUSH CURRENT[A]	ACIN 120V	20typ (Io=100%) (At cold start) (Ta=25°C)					
		ACIN 230V	40typ (Io=100%) (At cold start) (Ta=25°C)					
LEAKAGE CURRENT[mA]	0.125/0.250max (ACIN 120V/240V 60Hz,Io=100%, According to IEC60601-1)							
OUTPUT	VOLTAGE[V]	12	15	24	30	48	56	
	CURRENT[A]	Forced air	41.7	33.4	21.0	16.7	10.5	9.0
		Convection	9.2	7.4	4.6	3.7	2.3	1.9
		conduction cooling	16.7	13.4	8.4	6.7	4.2	3.6
	LINE REGULATION[mV] *4	48max	60max	96max	120max	192max	192max	
	LOAD REGULATION[mV] *4	100max	120max	150max	180max	240max	240max	
	RIPPLE[mVp-p] *1	0 to +50°C	240max	240max	240max	300max	300max	400max
		-20 - 0°C	320max	320max	320max	400max	400max	500max
	RIPPLE NOISE[mVp-p]*1	0 to +50°C	300max	300max	300max	480max	480max	500max
		-20 - 0°C	360max	360max	360max	500max	500max	580max
	TEMPERATURE REGULATION[mV]	0 to +50°C	120max	150max	240max	300max	480max	480max
		-20 to +50°C	150max	180max	290max	360max	600max	600max
	DRIFT[mV] *2	48max	60max	96max	120max	192max	192max	
	START-UP TIME[ms]	500typ (ACIN 120V, Io=100%)						
	HOLD-UP TIME[ms]	16typ (ACIN 120V, Io=100%)						
OUTPUT VOLTAGE ADJUSTMENT RANGE[V]	10.80 to 13.20	13.50 to 16.50	21.60 to 26.40	27.00 to 31.50	43.20 to 52.80	52.00 to 56.00		
OUTPUT VOLTAGE SETTING[V]	12.00 to 12.48	15.00 to 15.30	24.00 to 24.96	30.00 to 31.20	48.00 to 49.92	55.00 to 56.00		
PROTECTION CIRCUIT AND OTHERS	OVERCURRENT PROTECTION	Works over 105% of rating and recovers automatically						
	OVERVOLTAGE PROTECTION[V]	13.80 to 16.80	17.25 to 21.00	27.60 to 33.60	34.50 to 42.00	55.20 to 67.20	60.00 to 69.00	
	AUX1 (12V1A)	Optional						
	AUX2 (5V1A)	Optional						
	REMOTE ON/OFF	Optional						
ISOLATION	INPUT-OUTPUT · RC · AUX *7	AC4,000V 1minute, Cutoff current = 10mA, DC500V 50MΩ min (At Room Temperature)						
	INPUT-FG	AC2,000V 1minute, Cutoff current = 10mA, DC500V 50MΩ min (At Room Temperature)						
	OUTPUT · RC · AUX-FG *7	AC500V 1minute, Cutoff current = 25mA, DC500V 50MΩ min (At Room Temperature)						
	OUTPUT-RC · AUX *7	AC500V 1minute, Cutoff current = 25mA, DC500V 50MΩ min (At Room Temperature)						
ENVIRONMENT	OPERATING TEMP.,HUMID.AND ALTITUDE	-20 to +80°C, 20 - 90%RH (Non condensing), 3,000m (10,000feet) max						
	STORAGE TEMP.,HUMID.AND ALTITUDE	-30 to +80°C, 20 - 90%RH (Non condensing), 9,000m (30,000feet) max						
	VIBRATION	10 - 55Hz, 19.6m/s ² (2G), 3minutes period, 60minutes each along X, Y and Z axis						
	IMPACT	196.1m/s ² (20G), 11ms, once each X, Y and Z axis						
SAFETY AND NOISE REGULATIONS	AGENCY APPROVALS	UL60950-1, ANSI/AAMI ES60601-1, C-UL(CSA60950-1, CAN/CSA60601-1), EN60950-1, EN60601-1 3rd						
	CONDUCTED NOISE	Complies with FCC-B, VCCI-B, CISPR11-B, CISPR22-B, EN55011-B, EN55022-B						
	HARMONIC ATTENUATOR	Complies with IEC61000-3-2 (class A) *5						
OTHERS	CASE SIZE/WEIGHT	76.2×35×127mm [3.0×1.4×5.0 inches] (W×H×D) / 420g max						
	COOLING METHOD	Convection, Forced air (Require external fan), Conduction cooling						

*1 This is the value that measured on measuring board with capacitor of 22 μF at 150mm from output terminal.
 Measured by 20MHz oscilloscope or Ripple-Noise meter (Equivalent to KEISOKU-GIKEN: RM103).
 *2 Drift is the change in DC output for an eight hour period after a half-hour warm-up at 25°C, with the input voltage held constant at the rated input/output.
 *3 Derating is required.
 *4 Please contact us about dynamic load and input response.
 *5 Please contact us about another class.

*6 Specification is changed at option, refer to Instruction Manual
 *7 Applicable when AUX and remote control (optional) is added.
 * To meet the specifications. Do not operate over-loaded condition.
 * Sound noise may be generated by power supply in case of pulse load.
 * Parallel operation is available with -P option. Refer to 5.1on the instruction manual.
 * Forced air cooling is required to output up to MAX OUTPUT WATTAGE.

Features

- **Wattage 500W max**
- **High Power density:24.1W/inch³**
- **High efficiency 92% typ (Input Voltage 230V,Output Voltage 24V)**
- **Conduction cooling**
- **3" × 5" standard footprint**
- **Fits 1U applications**
- **Industrial and Medical safety approvals**
- **Low leakage current**
- **With Remote On/Off (Optional)**
- **With AUX1 (5V), AUX2 (12V) (Optional)**
- **No minimum load is required**

Block diagram

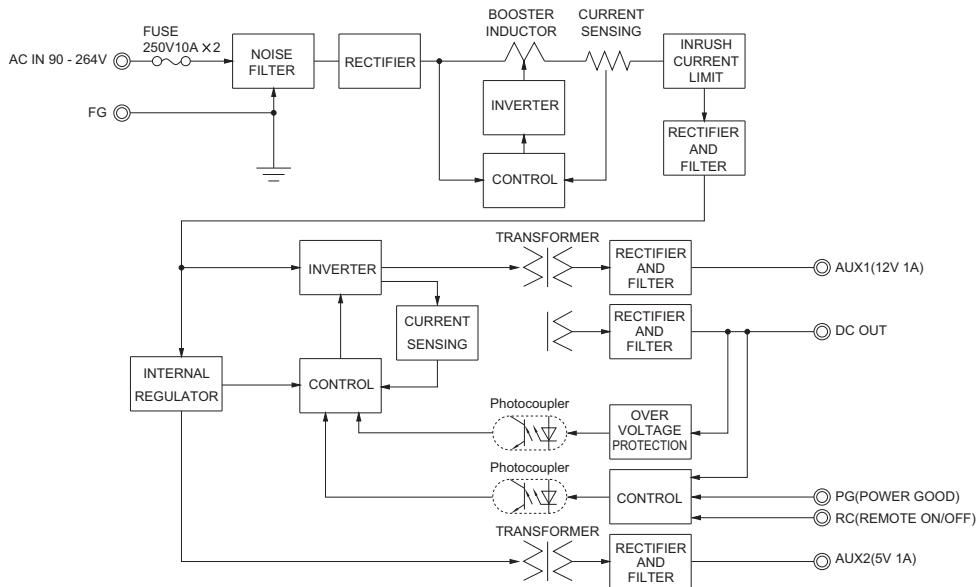

External view

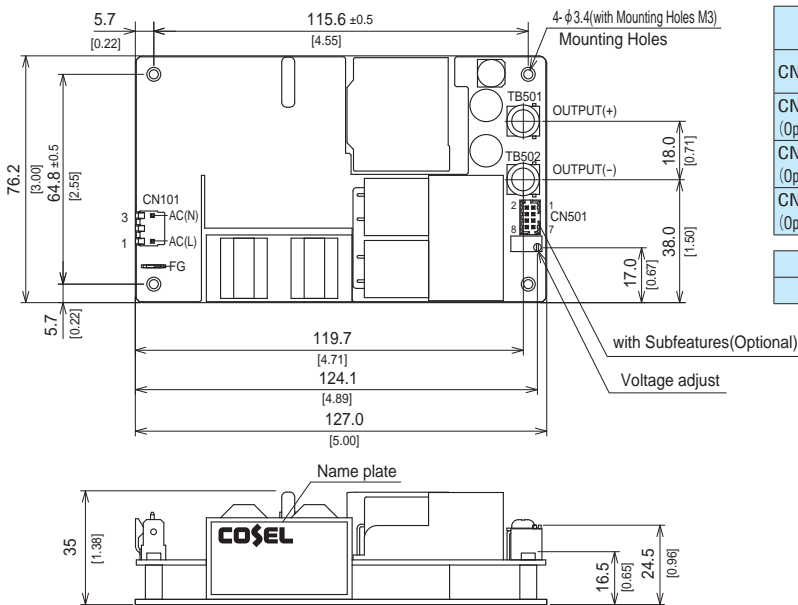

I/O Connector	Mating connector	Terminal	Mfr	
CN101	A-41671-A03A197-2	08-50-0105 08-65-0114	MOLEX	
CN501 (Optional)	087831-0820	51110-0851		50394-8051
CN101 (Optional)	B2P3-VH	VHR-3N	SVH-21T-P1.1	J.S.T.
CN501 (Optional)	B8B-PHDSS	PHDR-08VS	SPHD-002T-P0.5	

FG	Mating connector	Terminal	Mfr
-	250 Series	-	170603-2 Tyco Electronics

<Pin Assignments>

<CN101>

Pin No.	Input
1	AC(L)
2	
3	AC(N)

<CN501(Optional)>

Pin No.	Function
1	AUX1 : AUX1 (12V1A)
2	AUX1G: AUX1 (GND)
3	RC : REMOTE ON/OFF
4	RCG : REMOTE ON/OFF (GND)
5	PG : Power good
6	PGG : Power good (GND)
7	AUX2 : AUX2 (5V1A)
8	AUX2G: AUX2 (GND)

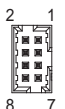

CN501

- ※ Tolerance ± 1 [± 0.04]
- ※ Weight : 420g max
- ※ There is a total of four attachment holes.
- ※ Base Plate : Aluminum
- ※ Dimensions in mm, []=inches
- ※ Screw tightening torque : (TB501, 502) : 1.5N · m max
- ※ Mounting torque : 0.6N · m max
- ※ Avoid contact between TB501 and 502 wiring with mounting parts.
- ※ Option : -J1 : (J.S.T) connector type. Refer to Instruction Manual 5.

GHA500F-SNF

GH A 500 F -□□ -SNF□

① ② ③ ④ ⑤ ⑥

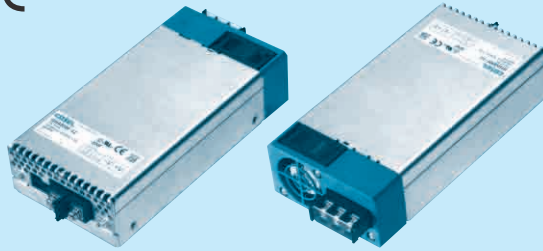

Recommended EMI/EMC Filter
EAC-10-472



High voltage pulse noise type : EAP series
Low leakage current type : EAM series
*The EMI/EMC Filter is recommended to connect with several devices.

- ① Series name
 - ② Single output
 - ③ Output wattage
 - ④ Universal input
 - ⑤ Output voltage
 - ⑥ Optional *6
 - J1 : CN501
VH(J.S.T.)connector type
 - P : Pallarell Operation
- Refer to the instruction manual 5.1.

MODEL	GHA500F-12-SNF	GHA500F-15-SNF	GHA500F-24-SNF	GHA500F-30-SNF	GHA500F-48-SNF	GHA500F-56-SNF	
MAX OUTPUT WATTAGE[W]	450	501	504	501	504	504	
DC OUTPUT	Forced air +50°C	12V 37.5A	15V 33.4A	24V 21.0A	30V 16.7A	48V 10.5A	56V 9.0A

SPECIFICATIONS

MODEL	GHA500F-12-SNF	GHA500F-15-SNF	GHA500F-24-SNF	GHA500F-30-SNF	GHA500F-48-SNF	GHA500F-56-SNF	
INPUT	AC90 - 264 1 φ (output derating is required at AC90V -115V *3)						
VOLTAGE[V]	ACIN 120V	4.8typ	5.4typ				
	ACIN 230V	2.6typ	2.9typ				
FREQUENCY[Hz]	50 / 60 (47 - 63)						
EFFICIENCY[%]	ACIN 120V	87typ	89typ	89typ	89typ	89typ	
	ACIN 230V	89typ	91typ	91typ	91typ	91typ	
POWER FACTOR (Io=100%)	ACIN 120V	0.95typ					
	ACIN 230V	0.90typ					
INRUSH CURRENT[A]	ACIN 120V	20typ (Io=100%) (At cold start) (Ta=25°C)					
	ACIN 230V	40typ (Io=100%) (At cold start) (Ta=25°C)					
LEAKAGE CURRENT[ma]	0.125/0.250max (ACIN 120V/240V 60Hz,Io=100%, According to IEC60601-1)						
OUTPUT	VOLTAGE[V]	12	15	24	30	48	56
CURRENT[A]	Forced air	37.5	33.4	21.0	16.7	10.5	9.0
		48max	60max	96max	120max	192max	192max
LINE REGULATION[mV] *4	100max						
LOAD REGULATION[mV] *4	120max						
RIPPLE[mVp-p] *1	0 to +50°C	240max	240max	240max	300max	300max	400max
	-20 - 0°C	320max	320max	320max	400max	400max	500max
RIPPLE NOISE[mVp-p]*1	0 to +50°C	300max	300max	300max	480max	480max	500max
	-20 - 0°C	360max	360max	360max	500max	500max	580max
TEMPERATURE REGULATION[mV]	0 to +50°C	120max	150max	240max	300max	480max	480max
	-20 to +50°C	150max	180max	290max	360max	600max	600max
DRIFT[mV] *2	48max						
START-UP TIME[ms]	500typ (ACIN 120V, Io=100%)						
HOLD-UP TIME[ms]	16typ (ACIN 120V, Io=100%)						
OUTPUT VOLTAGE ADJUSTMENT RANGE[V]	10.80 to 13.20						
OUTPUT VOLTAGE SETTING[V]	12.00 to 12.48						
OVERCURRENT PROTECTION	Works over 105% of rating and recovers automatically *7						
OVERVOLTAGE PROTECTION[V]	13.80 to 16.80						
PROTECTION CIRCUIT AND OTHERS	AUX1	12V 0.5A					
	AUX2	5V 1A					
	REMOTE ON/OFF	Possible, AUX2 is available					
	PowerGood	Open corrector					
ISOLATION	INPUT-OUTPUT · RC · AUX	AC4,000V 1minute, Cutoff current = 10mA, DC500V 50MΩ min (At Room Temperature)					
	INPUT-FG	AC2,000V 1minute, Cutoff current = 10mA, DC500V 50MΩ min (At Room Temperature)					
	OUTPUT · RC · AUX-FG	AC500V 1minute, Cutoff current = 25mA, DC500V 50MΩ min (At Room Temperature)					
	OUTPUT-RC · AUX	AC500V 1minute, Cutoff current = 25mA, DC500V 50MΩ min (At Room Temperature)					
ENVIRONMENT	OPERATING TEMP.,HUMID.AND ALTITUDE	-20 to +70°C, 20 - 90%RH (Non condensing), 3,000m (10,000feet) max *3					
	STORAGE TEMP.,HUMID.AND ALTITUDE	-30 to +80°C, 20 - 90%RH (Non condensing), 9,000m (30,000feet) max					
	VIBRATION	10 - 55Hz, 19.6m/s ² (2G), 3minutes period, 60minutes each along X, Y and Z axis					
	IMPACT	196.1m/s ² (20G), 11ms, once each X, Y and Z axis					
SAFETY AND NOISE REGULATIONS	AGENCY APPROVALS	UL60950-1, ANSI/AAMI ES60601-1, C-UL(CSA60950-1, CAN/CSA60601-1), EN60950-1, EN60601-1 3rd					
	CONDUCTED NOISE	Complies with FCC-B, VCCI-B, CISPR11-B, CISPR22-B, EN55011-B, EN55022-B					
	HARMONIC ATTENUATOR	Complies with IEC61000-3-2 (class A) *5					
OTHERS	CASE SIZE/WEIGHT	85.2 × 41 × 165.3mm [3.35 × 1.61 × 6.5 inches] (W × H × D) / 660g max					
	COOLING METHOD	Forced air					

*1 This is the value that measured on measuring board with capacitor of 22 μF at 150mm from output terminal.
Measured by 20MHz oscilloscope or Ripple-Noise meter (Equivalent to KEISOKU-GIKEN: RM103).

*2 Drift is the change in DC output for an eight hour period after a half-hour warm-up at 25°C, with the input voltage held constant at the rated input/output.

*3 Derating is required.

*4 Please contact us about dynamic load and input response.

*5 Please contact us about another class.

*6 Specification is changed at option, refer to Instruction Manual.

*7 When output current more than rated, output will shut down after 5 seconds or more. Recycle input after 3 minutes to reset the protection.

* To meet the specifications. Do not operate over-loaded condition.

* Sound noise may be generated by power supply in case of pulse load.

* Parallel operation is available with -P option. Refer to 5.1on the instruction manual.

Features

- Full packaged design united with GHA's features and additional robustness..
- High efficiency 91% typ (Input voltage 230V, Output voltage 24V)
- 50% minimized size compare with previous products.
- Optical for 1U applications
- Medical and Industrial safety approvals
- Low leakage current
- Conformal coating
- Single remote ON/OFF control for DC output, AUX1 and Fan.
- Isolated dual AUX (AUX1 12V 0.5A, AUX2 5V 1A)

Block diagram



External view

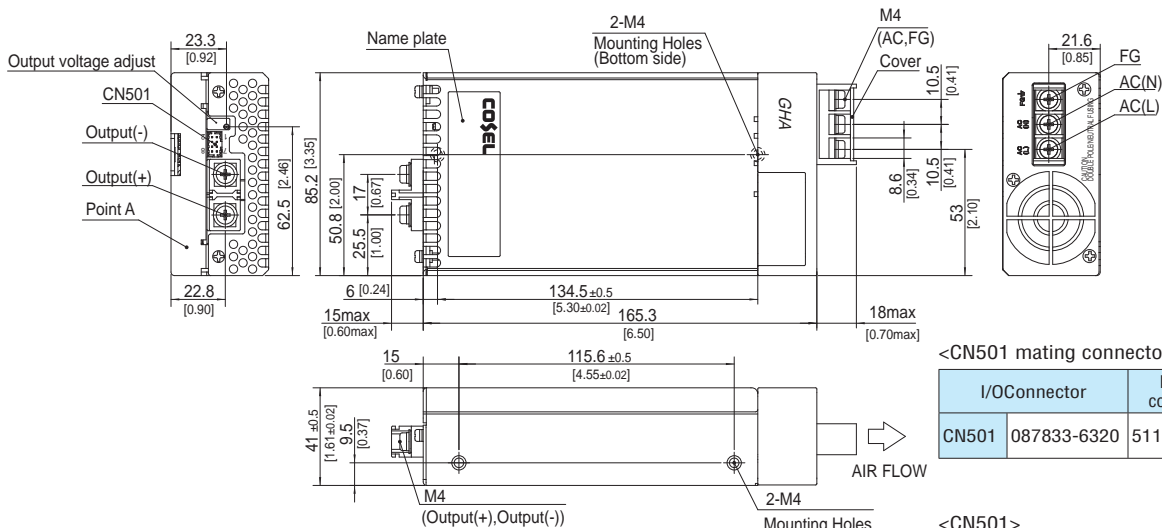

<CN501 mating connector and terminal>

I/O Connector	Mating connector	Terminal
CN501	087833-6320	51110-0851
		50394-8051

(Mfr : Molex)

<CN501>

Pin No.	Function
1	AUX1 : AUX1 (12V0.5A)
2	AUX1G: AUX1 (GND)
3	RC : REMOTE ON/OFF
4	RCG : REMOTE ON/OFF (GND)
5	PG : Power good
6	PGG : Power good (GND)
7	AUX2 : AUX2 (5V1A)
8	AUX2G: AUX2 (GND)

- ※ Tolerance ± 1 [± 0.04]
- ※ Weight : 660g max
- ※ Upper PCB Material/thickness : FR-4/1.6mm
- ※ Lower PCB Material/thickness : AL/1.5mm
- ※ Chassis Material/thickness : Aluminum/1.5mm
- ※ Cover Material/thickness : Aluminum/1.2mm
- ※ Fan cover Material : PBT
- ※ Mounting torque : 1.5N · m (14.7kgf · cm) max
- ※ Screw tightening torque M4 : 1.6N · m (16.9kgf · cm) max
- ※ Dimensions in mm, []=inches



Mouser Electronics

Authorized Distributor

Click to View Pricing, Inventory, Delivery & Lifecycle Information:

Cosel:

[GHA500F-48-SNF](#) [GHA500F-12-SNF](#) [GHA500F-24-SNF](#) [GHA500F-15-SNF](#)



Компания «ЭлектроПласт» предлагает заключение долгосрочных отношений при поставках импортных электронных компонентов на взаимовыгодных условиях!

Наши преимущества:

- Оперативные поставки широкого спектра электронных компонентов отечественного и импортного производства напрямую от производителей и с крупнейших мировых складов;
- Поставка более 17-ти миллионов наименований электронных компонентов;
- Поставка сложных, дефицитных, либо снятых с производства позиций;
- Оперативные сроки поставки под заказ (от 5 рабочих дней);
- Экспресс доставка в любую точку России;
- Техническая поддержка проекта, помощь в подборе аналогов, поставка прототипов;
- Система менеджмента качества сертифицирована по Международному стандарту ISO 9001;
- Лицензия ФСБ на осуществление работ с использованием сведений, составляющих государственную тайну;
- Поставка специализированных компонентов (Xilinx, Altera, Analog Devices, Intersil, Interpoint, Microsemi, Aeroflex, Peregrine, Syfer, Eurofarad, Texas Instrument, Miteq, Cobham, E2V, MA-COM, Hittite, Mini-Circuits, General Dynamics и др.);

Помимо этого, одним из направлений компании «ЭлектроПласт» является направление «Источники питания». Мы предлагаем Вам помощь Конструкторского отдела:

- Подбор оптимального решения, техническое обоснование при выборе компонента;
- Подбор аналогов;
- Консультации по применению компонента;
- Поставка образцов и прототипов;
- Техническая поддержка проекта;
- Защита от снятия компонента с производства.



Как с нами связаться

Телефон: 8 (812) 309 58 32 (многоканальный)

Факс: 8 (812) 320-02-42

Электронная почта: org@eplast1.ru

Адрес: 198099, г. Санкт-Петербург, ул. Калинина, дом 2, корпус 4, литера А.