

## 6A, 50V - 1000V Glass Passivated Single-Phase Bridge Rectifier

### FEATURES

- Ideal for printed circuit board
- High case dielectric strength of 1500 V<sub>RMS</sub>
- High surge current capability
- Typical I<sub>R</sub> less than 0.1μA
- UL Recognized File # E-326243
- Compliant to RoHS Directive 2011/65/EU and in accordance to WEEE 2002/96/EC
- Halogen-free according to IEC 61249-2-21

### APPLICATIONS

- Switching mode power supply (SMPS)
- Adapters
- TV
- Monitor

### MECHANICAL DATA

- Case: GBU
- Molding compound meets UL 94V-0 flammability rating
- Packing code with suffix "G" means green compound (halogen-free)
- Part no. with suffix "H" means AEC-Q101 qualified
- Terminal: Matte tin plated leads, solderable per J-STD-002
- Polarity: As marked
- Mounting torque: 0.56 Nm max
- Weight: 4 g (approximately)

| KEY PARAMETERS     |           |      |
|--------------------|-----------|------|
| PARAMETER          | VALUE     | UNIT |
| I <sub>F(AV)</sub> | 6         | A    |
| V <sub>RRM</sub>   | 50 - 1000 | V    |
| I <sub>FSM</sub>   | 175       | A    |
| T <sub>J MAX</sub> | 150       | °C   |
| Package            | GBU       |      |
| Configuration      | Quad      |      |

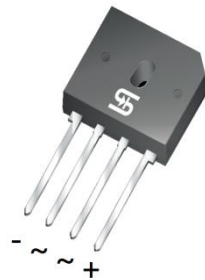

GBU

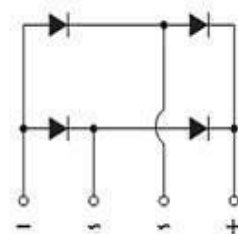

| ABSOLUTE MAXIMUM RATINGS (T <sub>A</sub> = 25°C unless otherwise noted)                        |                     |              |         |         |         |         |         |         |                  |
|------------------------------------------------------------------------------------------------|---------------------|--------------|---------|---------|---------|---------|---------|---------|------------------|
| PARAMETER                                                                                      | SYMBOL              | GBU 601      | GBU 602 | GBU 603 | GBU 604 | GBU 605 | GBU 606 | GBU 607 | UNIT             |
| Marking code on the device                                                                     |                     | GBU 601      | GBU 602 | GBU 603 | GBU 604 | GBU 605 | GBU 606 | GBU 607 |                  |
| Repetitive peak reverse voltage                                                                | V <sub>RRM</sub>    | 50           | 100     | 200     | 400     | 600     | 800     | 1000    | V                |
| Reverse voltage, total rms value                                                               | V <sub>R(RMS)</sub> | 35           | 70      | 140     | 280     | 420     | 560     | 700     | V                |
| Maximum DC blocking voltage                                                                    | V <sub>DC</sub>     | 50           | 100     | 200     | 400     | 600     | 800     | 1000    | V                |
| Forward current                                                                                | I <sub>F(AV)</sub>  | 6            |         |         |         |         |         |         | A                |
| Surge peak forward current, 8.3 ms single half sine-wave superimposed on rated load per diode) | I <sub>FSM</sub>    | 175          |         |         |         |         |         |         | A                |
| Rating of fusing ( t<8.3ms)                                                                    | I <sup>2</sup> t    | 127          |         |         |         |         |         |         | A <sup>2</sup> s |
| Junction temperature                                                                           | T <sub>J</sub>      | - 55 to +150 |         |         |         |         |         |         | °C               |
| Storage temperature                                                                            | T <sub>STG</sub>    | - 55 to +150 |         |         |         |         |         |         | °C               |

| <b>THERMAL PERFORMANCE</b>             |                 |              |             |
|----------------------------------------|-----------------|--------------|-------------|
| <b>PARAMETER</b>                       | <b>SYMBOL</b>   | <b>LIMIT</b> | <b>UNIT</b> |
| Junction-to-ambient thermal resistance | $R_{\theta JA}$ | 21           | °C/W        |
| Junction-to-case thermal resistance    | $R_{\theta JC}$ | 2            | °C/W        |

| <b>ELECTRICAL SPECIFICATIONS</b> ( $T_A = 25^\circ\text{C}$ unless otherwise noted) |                                           |               |            |            |               |
|-------------------------------------------------------------------------------------|-------------------------------------------|---------------|------------|------------|---------------|
| <b>PARAMETER</b>                                                                    | <b>CONDITIONS</b>                         | <b>SYMBOL</b> | <b>TYP</b> | <b>MAX</b> | <b>UNIT</b>   |
| Forward voltage per diode <sup>(1)</sup>                                            | $I_F = 3\text{A}, T_J = 25^\circ\text{C}$ | $V_F$         | -          | 1.0        | V             |
|                                                                                     | $I_F = 6\text{A}, T_J = 25^\circ\text{C}$ |               | -          | 1.1        | V             |
| Reverse current @ rated $V_R$ per diode <sup>(2)</sup>                              | $T_J = 25^\circ\text{C}$                  | $I_R$         | -          | 5          | $\mu\text{A}$ |
|                                                                                     | $T_J = 125^\circ\text{C}$                 |               | -          | 500        | $\mu\text{A}$ |
| Junction capacitance                                                                | 1 MHz, $V_R = 4.0\text{V}$                | $C_J$         | 211        | -          | pF            |
|                                                                                     |                                           |               | 94         | -          | pF            |

**Notes:**

- Pulse test with  $PW = 0.3\text{ ms}$
- Pulse test with  $PW = 30\text{ ms}$

| <b>ORDERING INFORMATION</b> |                        |                     |                               |                |                |
|-----------------------------|------------------------|---------------------|-------------------------------|----------------|----------------|
| <b>PART NO.</b>             | <b>PART NO. SUFFIX</b> | <b>PACKING CODE</b> | <b>PACKING CODE SUFFIX(*)</b> | <b>PACKAGE</b> | <b>PACKING</b> |
| GBU60x<br>(Note 1)          | H                      | C2                  | G                             | GBU            | 20 / Tube      |
|                             |                        | D2                  |                               |                | 20 / Tube      |
|                             |                        | X0                  |                               |                | Forming        |

**Note:**

- "x" defines voltage from 50V (GBU601) to 1000V (GBU607)

\*: Optional available

| <b>EXAMPLE P/N</b> |                 |                        |                     |                            |                                      |
|--------------------|-----------------|------------------------|---------------------|----------------------------|--------------------------------------|
| <b>EXAMPLE P/N</b> | <b>PART NO.</b> | <b>PART NO. SUFFIX</b> | <b>PACKING CODE</b> | <b>PACKING CODE SUFFIX</b> | <b>DESCRIPTION</b>                   |
| GBU606HC2G         | GBU606          | H                      | C2                  | G                          | AEC-Q101 qualified<br>Green compound |

**CHARACTERISTICS CURVES**

( $T_A = 25^\circ\text{C}$  unless otherwise noted)

**Fig.1 Forward Current Derating Curve**

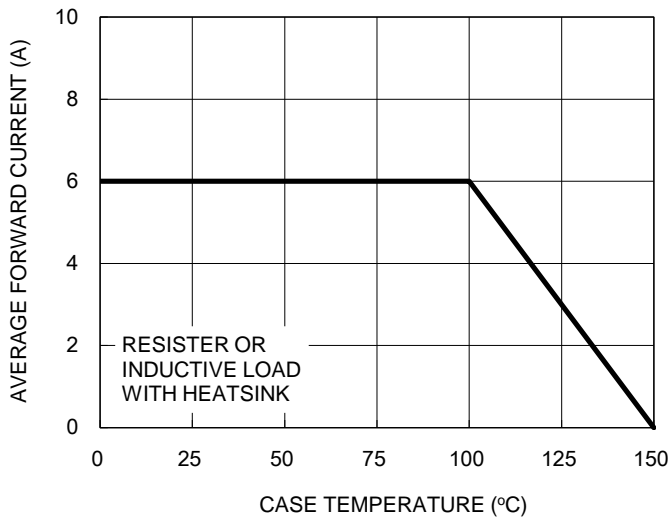

**Fig.2 Typical Junction Capacitance**

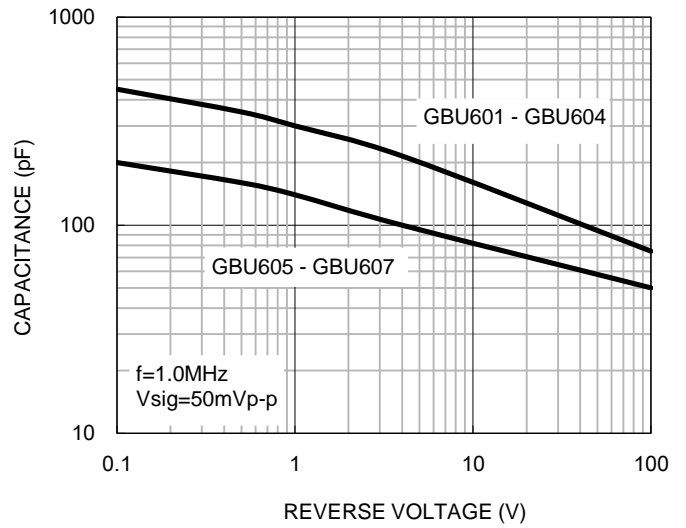

**Fig.3 Typical Reverse Characteristics**

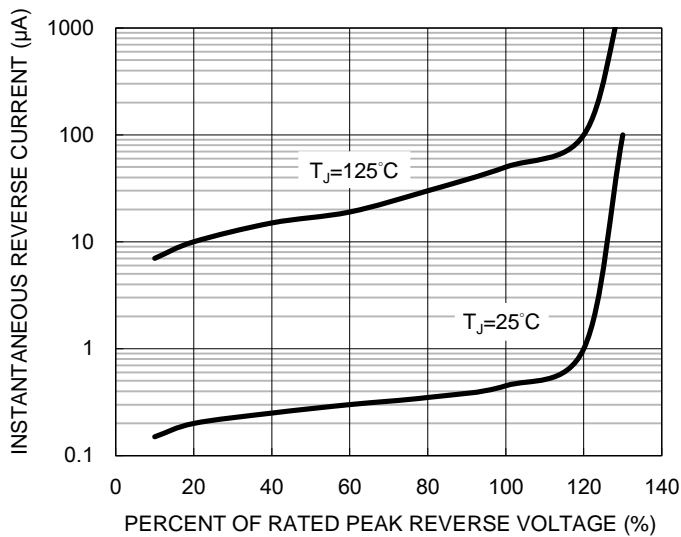

**Fig.4 Typical Forward Characteristics**

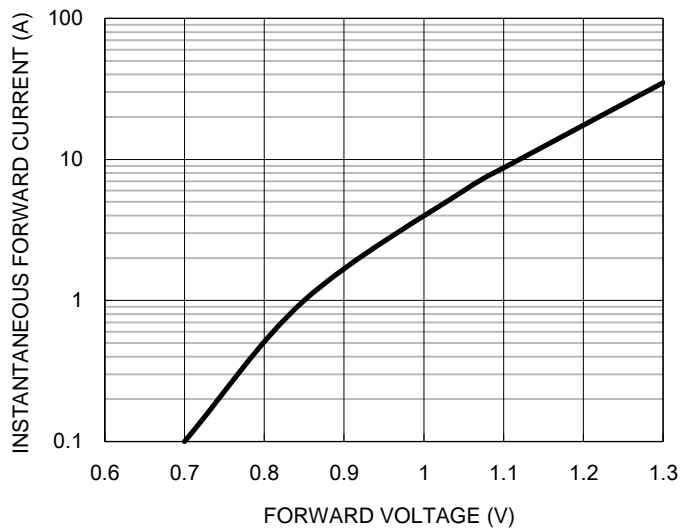

**CHARACTERISTICS CURVES**

(T<sub>A</sub> = 25°C unless otherwise noted)

**Fig.5 Maximum Non-repetitive Forward Surge Current**

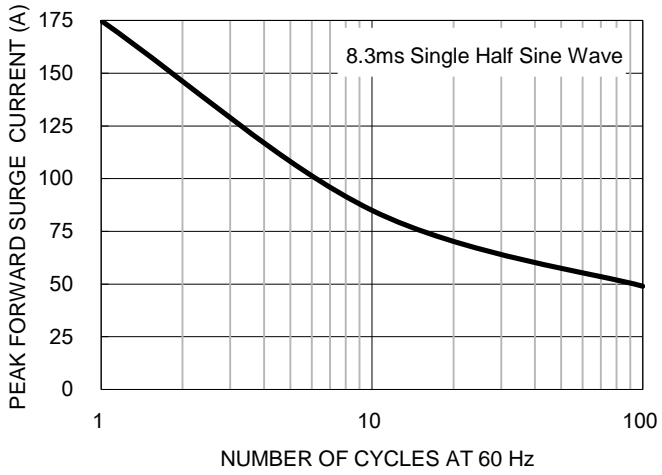

**PACKAGE OUTLINE DIMENSIONS**

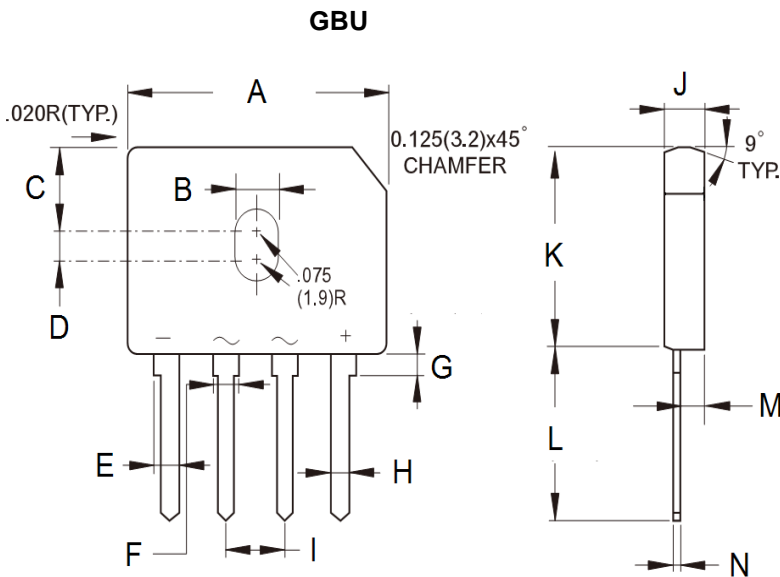

| DIM. | Unit (mm) |       | Unit (inch) |       |
|------|-----------|-------|-------------|-------|
|      | Min       | Max   | Min         | Max   |
| A    | 21.80     | 22.30 | 0.858       | 0.878 |
| B    | 3.50      | 4.10  | 0.138       | 0.161 |
| C    | 7.40      | 7.90  | 0.291       | 0.311 |
| D    | 1.65      | 2.16  | 0.065       | 0.085 |
| E    | 2.16      | 2.54  | 0.085       | 0.100 |
| F    | 1.65      | 2.03  | 0.065       | 0.080 |
| G    | 1.52      | 2.03  | 0.060       | 0.080 |
| H    | 1.02      | 1.27  | 0.040       | 0.050 |
| I    | 4.83      | 5.33  | 0.190       | 0.210 |
| J    | 3.30      | 3.56  | 0.130       | 0.140 |
| K    | 18.30     | 18.80 | 0.720       | 0.740 |
| L    | 17.50     | 18.00 | 0.689       | 0.709 |
| M    | 1.90      | 2.16  | 0.075       | 0.085 |
| N    | 0.46      | 0.56  | 0.018       | 0.022 |

**MARKING DIAGRAM**



- P/N = Marking Code
- G = Green Compound
- YWW = Date Code
- F = Factory Code

## Notice

Specifications of the products displayed herein are subject to change without notice. TSC or anyone on its behalf, assumes no responsibility or liability for any errors or inaccuracies.

Information contained herein is intended to provide a product description only. No license, express or implied, to any intellectual property rights is granted by this document. Except as provided in TSC's terms and conditions of sale for such products, TSC assumes no liability whatsoever, and disclaims any express or implied warranty, relating to sale and/or use of TSC products including liability or warranties relating to fitness for a particular purpose, merchantability, or infringement of any patent, copyright, or other intellectual property right.

The products shown herein are not designed for use in medical, life-saving, or life-sustaining applications. Customers using or selling these products for use in such applications do so at their own risk and agree to fully indemnify TSC for any damages resulting from such improper use or sale.



Компания «ЭлектроПласт» предлагает заключение долгосрочных отношений при поставках импортных электронных компонентов на взаимовыгодных условиях!

Наши преимущества:

- Оперативные поставки широкого спектра электронных компонентов отечественного и импортного производства напрямую от производителей и с крупнейших мировых складов;
- Поставка более 17-ти миллионов наименований электронных компонентов;
- Поставка сложных, дефицитных, либо снятых с производства позиций;
- Оперативные сроки поставки под заказ (от 5 рабочих дней);
- Экспресс доставка в любую точку России;
- Техническая поддержка проекта, помощь в подборе аналогов, поставка прототипов;
- Система менеджмента качества сертифицирована по Международному стандарту ISO 9001;
- Лицензия ФСБ на осуществление работ с использованием сведений, составляющих государственную тайну;
- Поставка специализированных компонентов (Xilinx, Altera, Analog Devices, Intersil, Interpoint, Microsemi, Aeroflex, Peregrine, Syfer, Eurofarad, Texas Instrument, Miteq, Cobham, E2V, MA-COM, Hittite, Mini-Circuits, General Dynamics и др.);

Помимо этого, одним из направлений компании «ЭлектроПласт» является направление «Источники питания». Мы предлагаем Вам помощь Конструкторского отдела:

- Подбор оптимального решения, техническое обоснование при выборе компонента;
- Подбор аналогов;
- Консультации по применению компонента;
- Поставка образцов и прототипов;
- Техническая поддержка проекта;
- Защита от снятия компонента с производства.



#### Как с нами связаться

**Телефон:** 8 (812) 309 58 32 (многоканальный)

**Факс:** 8 (812) 320-02-42

**Электронная почта:** [org@eplast1.ru](mailto:org@eplast1.ru)

**Адрес:** 198099, г. Санкт-Петербург, ул. Калинина, дом 2, корпус 4, литера А.