

6A, 50V - 1000V Glass Passivated Single-Phase Bridge Rectifier

FEATURES

- Ideal for printed circuit board
- High case dielectric strength of 1500 V_{RMS}
- High surge current capability
- Typical I_R less than 0.1μA
- UL Recognized File # E-326243
- Compliant to RoHS Directive 2011/65/EU and in accordance to WEEE 2002/96/EC
- Halogen-free according to IEC 61249-2-21

APPLICATIONS

- Switching mode power supply (SMPS)
- Adapters
- TV
- Monitor

MECHANICAL DATA

- Case: GBU
- Molding compound meets UL 94V-0 flammability rating
- Packing code with suffix "G" means green compound (halogen-free)
- Part no. with suffix "H" means AEC-Q101 qualified
- Terminal: Matte tin plated leads, solderable per J-STD-002
- Polarity: As marked
- Mounting torque: 0.56 Nm max
- Weight: 4 g (approximately)

KEY PARAMETERS		
PARAMETER	VALUE	UNIT
I _{F(AV)}	6	A
V _{RRM}	50 - 1000	V
I _{FSM}	175	A
T _{J MAX}	150	°C
Package	GBU	
Configuration	Quad	

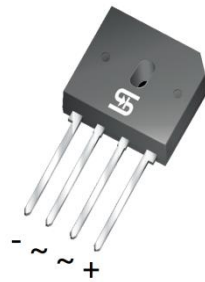

GBU

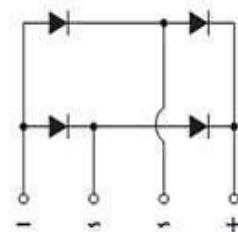

ABSOLUTE MAXIMUM RATINGS (T _A = 25°C unless otherwise noted)									
PARAMETER	SYMBOL	GBU 601	GBU 602	GBU 603	GBU 604	GBU 605	GBU 606	GBU 607	UNIT
Marking code on the device		GBU 601	GBU 602	GBU 603	GBU 604	GBU 605	GBU 606	GBU 607	
Repetitive peak reverse voltage	V _{RRM}	50	100	200	400	600	800	1000	V
Reverse voltage, total rms value	V _{R(RMS)}	35	70	140	280	420	560	700	V
Maximum DC blocking voltage	V _{DC}	50	100	200	400	600	800	1000	V
Forward current	I _{F(AV)}	6							A
Surge peak forward current, 8.3 ms single half sine-wave superimposed on rated load per diode)	I _{FSM}	175							A
Rating of fusing (t<8.3ms)	I ² t	127							A ² s
Junction temperature	T _J	- 55 to +150							°C
Storage temperature	T _{STG}	- 55 to +150							°C

THERMAL PERFORMANCE			
PARAMETER	SYMBOL	LIMIT	UNIT
Junction-to-ambient thermal resistance	$R_{\theta JA}$	21	°C/W
Junction-to-case thermal resistance	$R_{\theta JC}$	2	°C/W

ELECTRICAL SPECIFICATIONS ($T_A = 25^\circ\text{C}$ unless otherwise noted)						
PARAMETER	CONDITIONS	SYMBOL	TYP	MAX	UNIT	
Forward voltage per diode ⁽¹⁾	$I_F = 3\text{A}, T_J = 25^\circ\text{C}$	V_F	-	1.0	V	
	$I_F = 6\text{A}, T_J = 25^\circ\text{C}$		-	1.1	V	
Reverse current @ rated V_R per diode ⁽²⁾	$T_J = 25^\circ\text{C}$	I_R	-	5	μA	
	$T_J = 125^\circ\text{C}$		-	500	μA	
Junction capacitance	1 MHz, $V_R = 4.0\text{V}$	C_J	211	-	pF	
						94
			GBU601			
			GBU602			
			GBU603			
GBU604						
GBU605						
GBU606						
GBU607						

Notes:

1. Pulse test with $PW = 0.3\text{ ms}$
2. Pulse test with $PW = 30\text{ ms}$

ORDERING INFORMATION					
PART NO.	PART NO. SUFFIX	PACKING CODE	PACKING CODE SUFFIX(*)	PACKAGE	PACKING
GBU60x (Note 1)	H	C2	G	GBU	20 / Tube
		D2			20 / Tube
		X0			Forming

Note:

1. "x" defines voltage from 50V (GBU601) to 1000V (GBU607)

*: Optional available

EXAMPLE P/N					
EXAMPLE P/N	PART NO.	PART NO. SUFFIX	PACKING CODE	PACKING CODE SUFFIX	DESCRIPTION
GBU606HC2G	GBU606	H	C2	G	AEC-Q101 qualified Green compound

CHARACTERISTICS CURVES

($T_A = 25^\circ\text{C}$ unless otherwise noted)

Fig.1 Forward Current Derating Curve

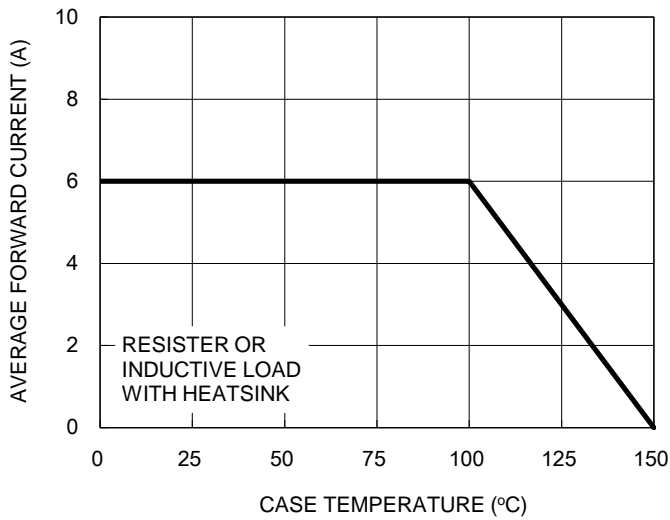

Fig.2 Typical Junction Capacitance

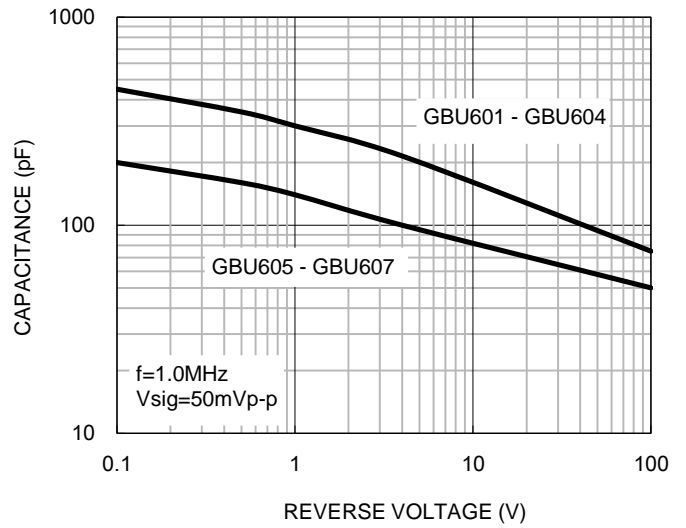

Fig.3 Typical Reverse Characteristics

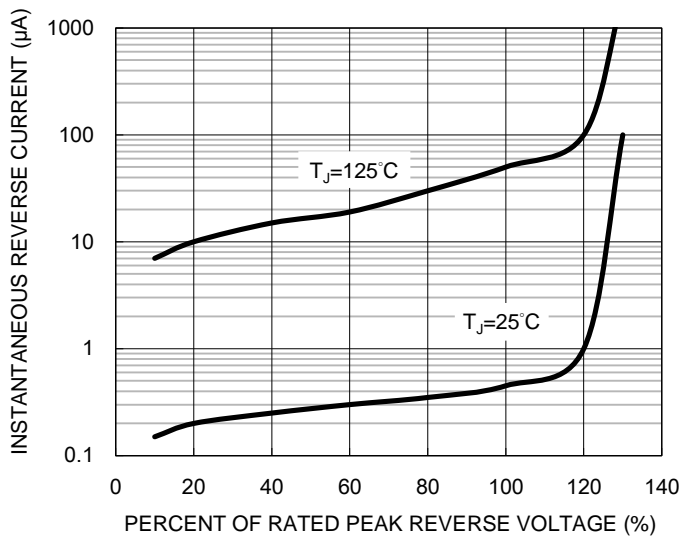
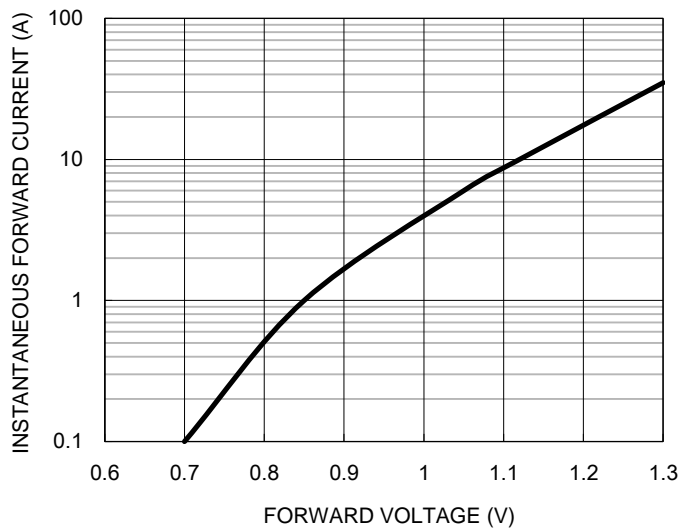

Fig.4 Typical Forward Characteristics



CHARACTERISTICS CURVES

($T_A = 25^\circ\text{C}$ unless otherwise noted)

Fig.5 Maximum Non-repetitive Forward Surge Current

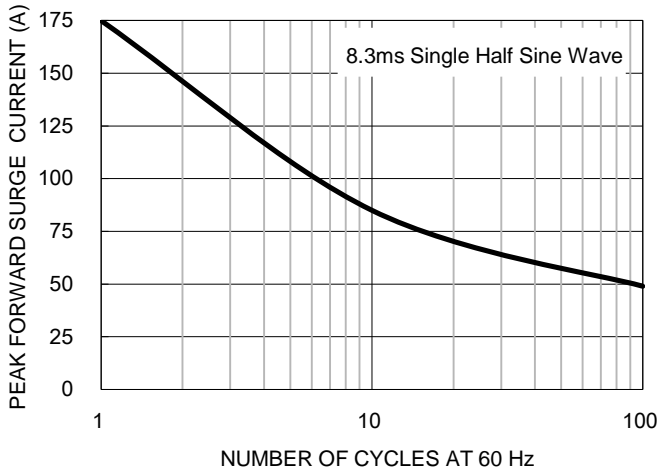

PACKAGE OUTLINE DIMENSIONS

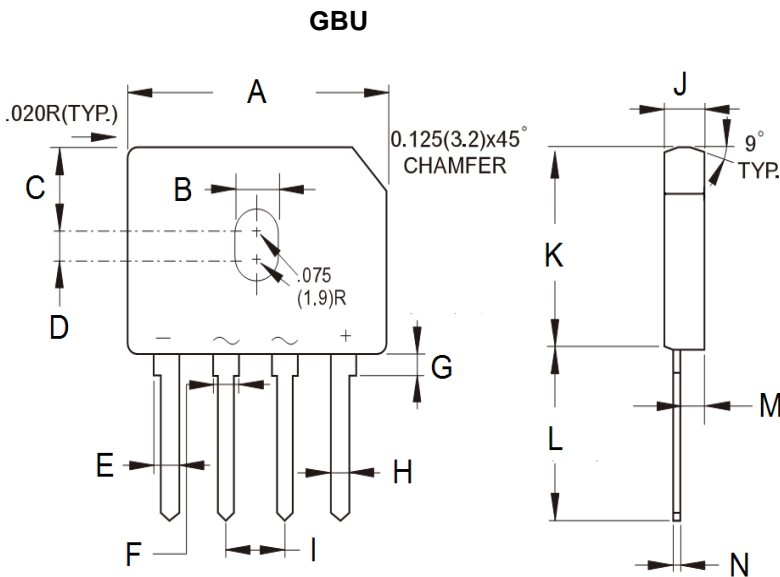

DIM.	Unit (mm)		Unit (inch)	
	Min	Max	Min	Max
A	21.80	22.30	0.858	0.878
B	3.50	4.10	0.138	0.161
C	7.40	7.90	0.291	0.311
D	1.65	2.16	0.065	0.085
E	2.16	2.54	0.085	0.100
F	1.65	2.03	0.065	0.080
G	1.52	2.03	0.060	0.080
H	1.02	1.27	0.040	0.050
I	4.83	5.33	0.190	0.210
J	3.30	3.56	0.130	0.140
K	18.30	18.80	0.720	0.740
L	17.50	18.00	0.689	0.709
M	1.90	2.16	0.075	0.085
N	0.46	0.56	0.018	0.022

MARKING DIAGRAM



- P/N = Marking Code
- G = Green Compound
- YWW = Date Code
- F = Factory Code

Notice

Specifications of the products displayed herein are subject to change without notice. TSC or anyone on its behalf, assumes no responsibility or liability for any errors or inaccuracies.

Information contained herein is intended to provide a product description only. No license, express or implied, to any intellectual property rights is granted by this document. Except as provided in TSC's terms and conditions of sale for such products, TSC assumes no liability whatsoever, and disclaims any express or implied warranty, relating to sale and/or use of TSC products including liability or warranties relating to fitness for a particular purpose, merchantability, or infringement of any patent, copyright, or other intellectual property right.

The products shown herein are not designed for use in medical, life-saving, or life-sustaining applications. Customers using or selling these products for use in such applications do so at their own risk and agree to fully indemnify TSC for any damages resulting from such improper use or sale.



Компания «ЭлектроПласт» предлагает заключение долгосрочных отношений при поставках импортных электронных компонентов на взаимовыгодных условиях!

Наши преимущества:

- Оперативные поставки широкого спектра электронных компонентов отечественного и импортного производства напрямую от производителей и с крупнейших мировых складов;
- Поставка более 17-ти миллионов наименований электронных компонентов;
- Поставка сложных, дефицитных, либо снятых с производства позиций;
- Оперативные сроки поставки под заказ (от 5 рабочих дней);
- Экспресс доставка в любую точку России;
- Техническая поддержка проекта, помощь в подборе аналогов, поставка прототипов;
- Система менеджмента качества сертифицирована по Международному стандарту ISO 9001;
- Лицензия ФСБ на осуществление работ с использованием сведений, составляющих государственную тайну;
- Поставка специализированных компонентов (Xilinx, Altera, Analog Devices, Intersil, Interpoint, Microsemi, Aeroflex, Peregrine, Syfer, Eurofarad, Texas Instrument, Miteq, Cobham, E2V, MA-COM, Hittite, Mini-Circuits, General Dynamics и др.);

Помимо этого, одним из направлений компании «ЭлектроПласт» является направление «Источники питания». Мы предлагаем Вам помощь Конструкторского отдела:

- Подбор оптимального решения, техническое обоснование при выборе компонента;
- Подбор аналогов;
- Консультации по применению компонента;
- Поставка образцов и прототипов;
- Техническая поддержка проекта;
- Защита от снятия компонента с производства.



Как с нами связаться

Телефон: 8 (812) 309 58 32 (многоканальный)

Факс: 8 (812) 320-02-42

Электронная почта: org@eplast1.ru

Адрес: 198099, г. Санкт-Петербург, ул. Калинина, дом 2, корпус 4, литера А.