

L, S-BAND SPDT SWITCH

DESCRIPTION

The μ PG2214TK is a GaAs MMIC for L, S-band SPDT (Single Pole Double Throw) switch which was developed for mobile phone and another L, S-band application.

This device can operate 2 control switching by control voltage 1.8 to 5.3 V. This device can operate frequency from 0.05 to 3.0 GHz, having the low insertion loss and high isolation.

This device is housed in a 6-pin lead-less minimold (1511) package. And this package is able to high-density surface mounting.

FEATURES

- Switch control voltage : $V_{\text{cont (H)}} = 1.8 \text{ to } 5.3 \text{ V (3.0 V TYP.)}$
: $V_{\text{cont (L)}} = -0.2 \text{ to } +0.2 \text{ V (0 V TYP.)}$
- Low insertion loss : $L_{\text{ins1}} = 0.25 \text{ dB TYP. @ } f = 0.05 \text{ to } 0.5 \text{ GHz, } V_{\text{cont (H)}} = 3.0 \text{ V, } V_{\text{cont (L)}} = 0 \text{ V}$
: $L_{\text{ins2}} = 0.25 \text{ dB TYP. @ } f = 0.5 \text{ to } 1.0 \text{ GHz, } V_{\text{cont (H)}} = 3.0 \text{ V, } V_{\text{cont (L)}} = 0 \text{ V}$
: $L_{\text{ins3}} = 0.30 \text{ dB TYP. @ } f = 1.0 \text{ to } 2.0 \text{ GHz, } V_{\text{cont (H)}} = 3.0 \text{ V, } V_{\text{cont (L)}} = 0 \text{ V}$
: $L_{\text{ins4}} = 0.35 \text{ dB TYP. @ } f = 2.0 \text{ to } 2.5 \text{ GHz, } V_{\text{cont (H)}} = 3.0 \text{ V, } V_{\text{cont (L)}} = 0 \text{ V}$
: $L_{\text{ins5}} = 0.35 \text{ dB TYP. @ } f = 2.5 \text{ to } 3.0 \text{ GHz, } V_{\text{cont (H)}} = 3.0 \text{ V, } V_{\text{cont (L)}} = 0 \text{ V}$
- High isolation : $ISL1 = 32 \text{ dB TYP. @ } f = 0.05 \text{ to } 0.5 \text{ GHz, } V_{\text{cont (H)}} = 3.0 \text{ V, } V_{\text{cont (L)}} = 0 \text{ V}$
: $ISL2 = 28 \text{ dB TYP. @ } f = 0.5 \text{ to } 1.0 \text{ GHz, } V_{\text{cont (H)}} = 3.0 \text{ V, } V_{\text{cont (L)}} = 0 \text{ V}$
: $ISL3 = 27 \text{ dB TYP. @ } f = 1.0 \text{ to } 2.0 \text{ GHz, } V_{\text{cont (H)}} = 3.0 \text{ V, } V_{\text{cont (L)}} = 0 \text{ V}$
: $ISL4 = 26 \text{ dB TYP. @ } f = 2.0 \text{ to } 2.5 \text{ GHz, } V_{\text{cont (H)}} = 3.0 \text{ V, } V_{\text{cont (L)}} = 0 \text{ V}$
: $ISL5 = 24 \text{ dB TYP. @ } f = 2.5 \text{ to } 3.0 \text{ GHz, } V_{\text{cont (H)}} = 3.0 \text{ V, } V_{\text{cont (L)}} = 0 \text{ V}$
- Handling power : $P_{\text{in (1 dB)}} = +27.0 \text{ dBm TYP. @ } f = 0.5 \text{ to } 3.0 \text{ GHz, } V_{\text{cont (H)}} = 3.0 \text{ V, } V_{\text{cont (L)}} = 0 \text{ V}$
: $P_{\text{in (1 dB)}} = +20.0 \text{ dBm TYP. @ } f = 0.5 \text{ to } 3.0 \text{ GHz, } V_{\text{cont (H)}} = 1.8 \text{ V, } V_{\text{cont (L)}} = 0 \text{ V}$
- High-density surface mounting : 6-pin lead-less minimold package (1.5 × 1.1 × 0.55 mm)

APPLICATIONS

- L, S-band digital cellular or cordless telephone
- W-LAN, WLL and Bluetooth™ etc.

ORDERING INFORMATION

Part Number	Package	Marking	Supplying Form
μ PG2214TK-E2	6-pin lead-less minimold (1511)	G4K	<ul style="list-style-type: none"> • Embossed tape 8 mm wide • Pin 1, 6 face the perforation side of the tape • Qty 5 kpcs/reel

Remark To order evaluation samples, contact your nearby sales office.

Part number for sample order: μ PG2214TK-A

Caution: Observe precautions when handling because these devices are sensitive to electrostatic discharge

The information in this document is subject to change without notice. Before using this document, please confirm that this is the latest version.

PIN CONNECTIONS AND INTERNAL BLOCK DIAGRAM

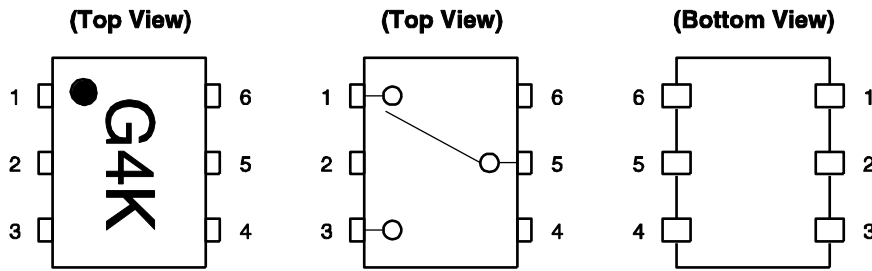

Pin No.	Pin Name
1	OUTPUT1
2	GND
3	OUTPUT2
4	V _{cont2}
5	INPUT
6	V _{cont1}

TRUTH TABLE

V _{cont1}	V _{cont2}	INPUT-OUTPUT1	INPUT-OUTPUT2
Low	High	ON	OFF
High	Low	OFF	ON

ABSOLUTE MAXIMUM RATINGS (T_A = +25°C, unless otherwise specified)

Parameter	Symbol	Ratings	Unit
Switch Control Voltage	V _{cont}	+6.0 ^{Note}	V
Input Power	P _{in}	+30	dBm
Operating Ambient Temperature	T _A	-45 to +85	°C
Storage Temperature	T _{stg}	-55 to +150	°C

Note |V_{cont1} - V_{cont2}| ≤ 6.0 V

RECOMMENDED OPERATING RANGE (T_A = +25°C, unless otherwise specified)

Parameter	Symbol	MIN.	TYP.	MAX.	Unit
Switch Control Voltage (H)	V _{cont (H)}	1.8	3.0	5.3	V
Switch Control Voltage (L)	V _{cont (L)}	-0.2	0	0.2	V

ELECTRICAL CHARACTERISTICS

(T_A = +25°C, V_{cont} (H) = 3.0 V, V_{cont} (L) = 0 V, DC cut capacitors = 100 pF, unless otherwise specified)

Parameter	Symbol	Test Conditions	MIN.	TYP.	MAX.	Unit
Insertion Loss 1	L _{ins1}	f = 0.05 to 0.5 GHz ^{Note 1}	–	0.25	0.45	dB
Insertion Loss 2	L _{ins2}	f = 0.5 to 1.0 GHz	–	0.25	0.45	dB
Insertion Loss 3	L _{ins3}	f = 1.0 to 2.0 GHz	–	0.30	0.50	dB
Insertion Loss 4	L _{ins4}	f = 2.0 to 2.5 GHz	–	0.35	0.55	dB
Insertion Loss 5	L _{ins5}	f = 2.5 to 3.0 GHz	–	0.35	0.60	dB
Isolation 1	ISL1	f = 0.05 to 0.5 GHz ^{Note 1}	29	32	–	dB
Isolation 2	ISL2	f = 0.5 to 1.0 GHz	25	28	–	dB
Isolation 3	ISL3	f = 1.0 to 2.0 GHz	24	27	–	dB
Isolation 4	ISL4	f = 2.0 to 2.5 GHz	23	26	–	dB
Isolation 5	ISL5	f = 2.5 to 3.0 GHz	21	24	–	dB
Input Return Loss 1	RL _{in1}	f = 0.05 to 0.5 GHz ^{Note 1}	15	20	–	dB
Input Return Loss 2	RL _{in2}	f = 0.5 to 3.0 GHz	15	20	–	dB
Output Return Loss 1	RL _{out1}	f = 0.05 to 0.5 GHz ^{Note 1}	15	20	–	dB
Output Return Loss 2	RL _{out2}	f = 0.5 to 3.0 GHz	15	20	–	dB
0.1 dB Loss Compression Input Power ^{Note 2}	P _{in (0.1 dB)}	f = 2.0/2.5 GHz	+21.0	+23.0	–	dBm
		f = 0.5 to 3.0 GHz	–	+23.0	–	dBm
1 dB Loss Compression Input Power ^{Note 3}	P _{in (1 dB)}	f = 0.5 to 3.0 GHz	–	+27.0	–	dBm
2nd Harmonics	2f ₀	f = 2.0 GHz, P _{in} = +15 dBm	–	–55	–47	dBc
		f = 2.5 GHz, P _{in} = +15 dBm	–	–55	–47	dBc
3rd Harmonics	3f ₀	f = 2.0 GHz, P _{in} = +15 dBm	–	–55	–47	dBc
		f = 2.5 GHz, P _{in} = +15 dBm	–	–55	–47	dBc
Intermodulation Intercept Point	IIP ₃	f = 0.5 to 3.0 GHz, 2 tone, P _{in} = +16 dBm, 5 MHz spicing	–	+58	–	dBm
Switch Control Current	I _{cont}		–	4	20	μA
Switch Control Speed	t _{sw}	50% CTL to 90/10% RF	–	20	200	ns

Notes 1. DC cut capacitors = 1 000 pF at f = 0.05 to 0.5 GHz

- 2.** P_{in (0.1 dB)} is measured the input power level when the insertion loss increases more 0.1 dB than that of linear range.
- 3.** P_{in (1 dB)} is measured the input power level when the insertion loss increases more 1 dB than that of linear range.

ELECTRICAL CHARACTERISTICS

(T_A = +25°C, V_{cont} (H) = 1.8 V, V_{cont} (L) = 0 V, DC cut capacitors = 100 pF, unless otherwise specified)

Parameter	Symbol	Test Conditions	MIN.	TYP.	MAX.	Unit
Insertion Loss 6	L _{ins6}	f = 0.05 to 0.5 GHz ^{Note 1}	–	0.25	0.50	dB
Insertion Loss 7	L _{ins7}	f = 0.5 to 1.0 GHz	–	0.25	0.50	dB
Insertion Loss 8	L _{ins8}	f = 1.0 to 2.0 GHz	–	0.30	0.55	dB
Insertion Loss 9	L _{ins9}	f = 2.0 to 2.5 GHz	–	0.35	0.60	dB
Insertion Loss 10	L _{ins10}	f = 2.5 to 3.0 GHz	–	0.35	0.65	dB
Isolation 6	ISL6	f = 0.05 to 0.5 GHz ^{Note 1}	27	30	–	dB
Isolation 7	ISL7	f = 0.5 to 2.0 GHz	23	27	–	dB
Isolation 8	ISL8	f = 2.0 to 2.5 GHz	21	25	–	dB
Isolation 9	ISL9	f = 2.5 to 3.0 GHz	20	24	–	dB
Input Return Loss 3	RL _{in3}	f = 0.05 to 3.0 GHz ^{Note 1}	15	20	–	dB
Output Return Loss 3	RL _{out3}	f = 0.05 to 3.0 GHz ^{Note 1}	15	20	–	dB
0.1 dB Loss Compression Input Power ^{Note 2}	P _{in (0.1 dB)}	f = 2.0/2.5 GHz	+14.0	+17.0	–	dBm
		f = 0.5 to 3.0 GHz	–	+17.0	–	dBm
1 dB Loss Compression Input Power ^{Note 3}	P _{in (1 dB)}	f = 0.5 to 3.0 GHz	–	+20.0	–	dBm
Switch Control Current	I _{cont}		–	4	20	μA
Switch Control Speed	t _{sw}	50% CTL to 90/10% RF	–	20	200	ns

Notes 1. DC cut capacitors = 1 000 pF at f = 0.05 to 0.5 GHz

- 2.** P_{in (0.1 dB)} is measured the input power level when the insertion loss increases more 0.1 dB than that of linear range.
- 3.** P_{in (1 dB)} is measured the input power level when the insertion loss increases more 1 dB than that of linear range.

Caution This device is used it is necessary to use DC cut capacitors.

The value of DC cut capacitors should be chosen to accommodate the frequency of operation, bandwidth, switching speed and the condition with actual board of your system. The range of recommended DC cut capacitor value is less than 100 pF.

EVALUATION CIRCUIT

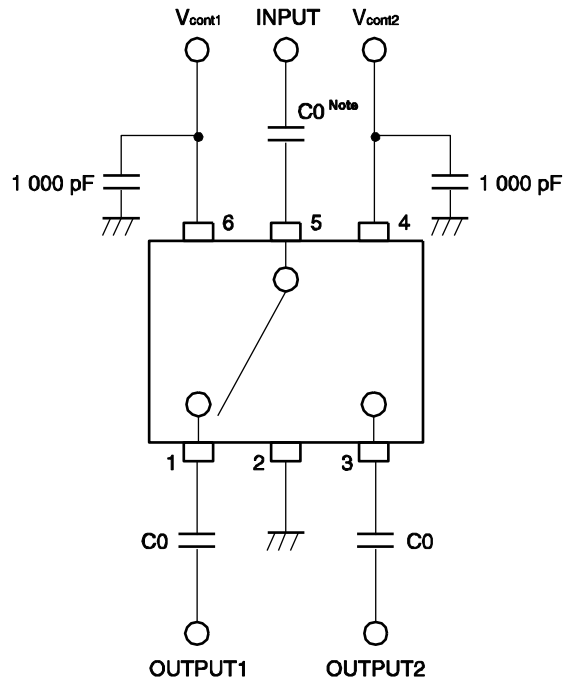

Note C0 : 0.05 to 0.5 GHz 1 000 pF
 : 0.5 to 3.0 GHz 100 pF

The application circuits and their parameters are for reference only and are not intended for use in actual design-ins.

ILLUSTRATION OF THE TEST CIRCUIT ASSEMBLED ON EVALUATION BOARD

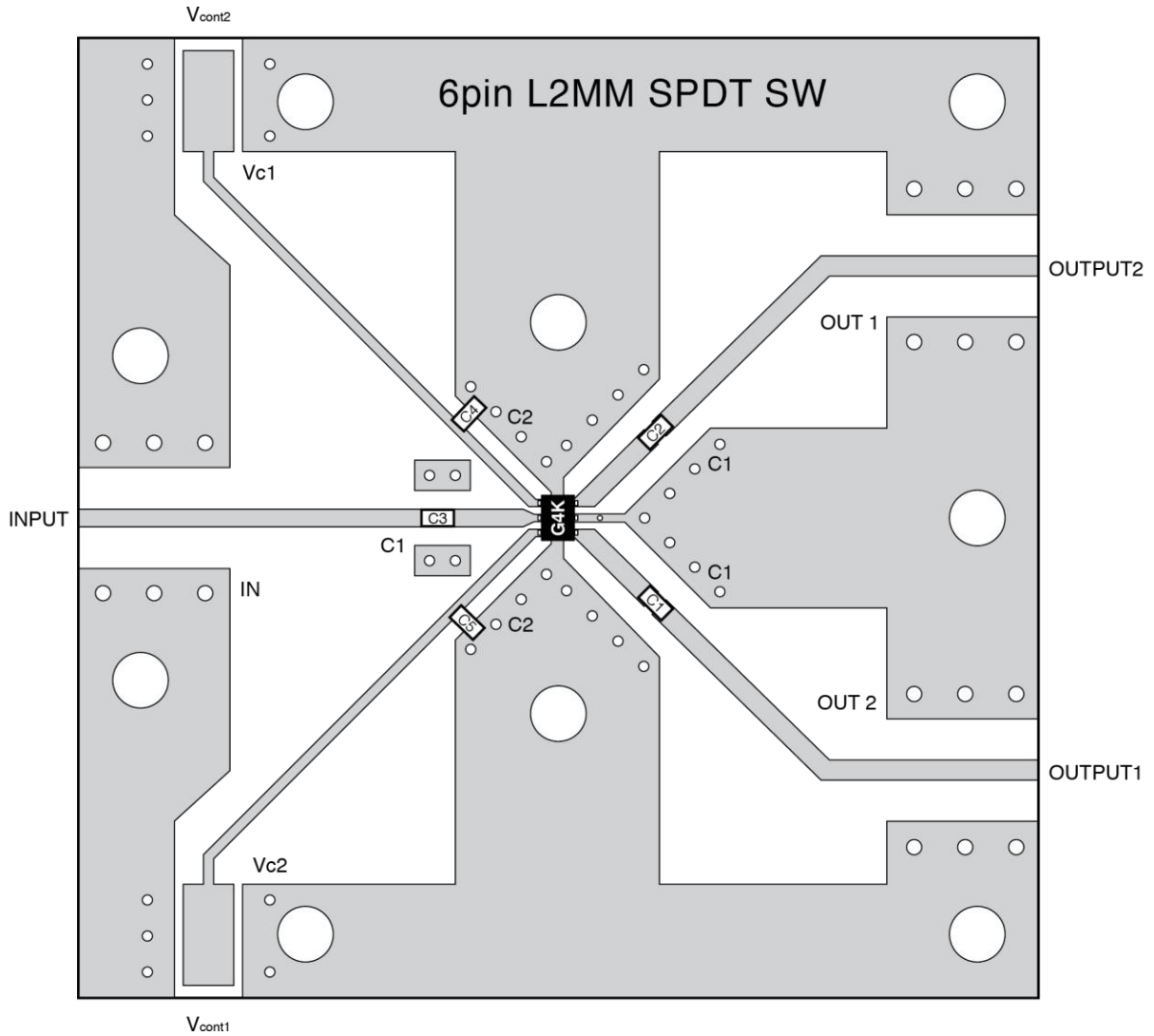

USING THE EVALUATION BOARD

Symbol	Values
C1, C2, C3	100 pF
C4, C5	1 000 pF

★ TYPICAL CHARACTERISTICS

($T_A = +25^\circ\text{C}$, $V_{\text{cont (H)}} = 3.0\text{ V}$, $V_{\text{cont (L)}} = 0\text{ V}$, DC cut capacitors = 100 pF, unless otherwise specified)

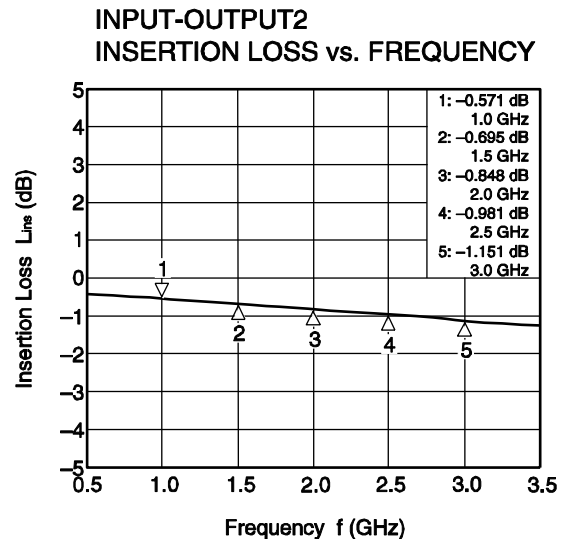
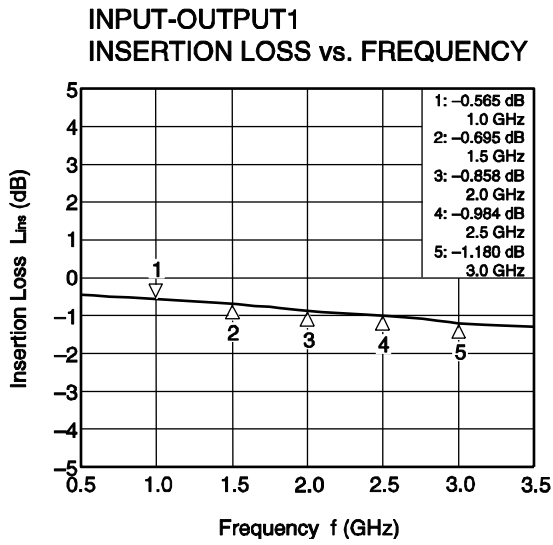

Remark The graphs indicate nominal characteristics.

Caution These characteristics values include the losses of the evaluation board.

**INPUT-OUTPUT1
ISOLATION vs. FREQUENCY**

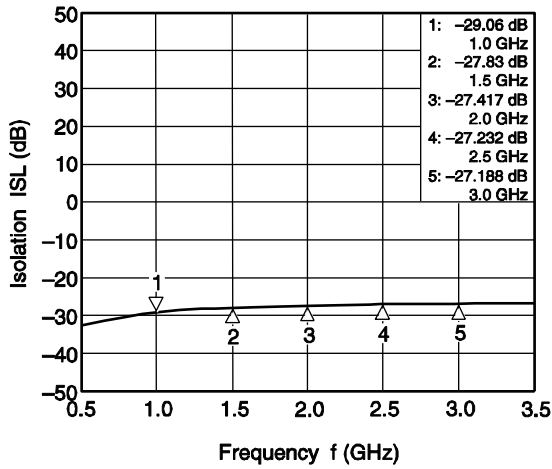

**INPUT-OUTPUT2
ISOLATION vs. FREQUENCY**

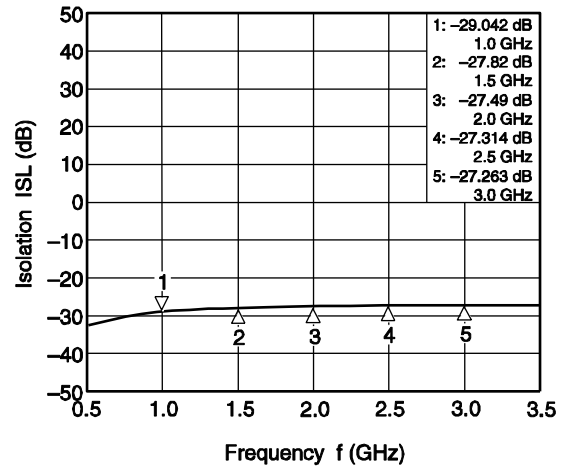

**INPUT-OUTPUT1
INPUT RETURN LOSS vs. FREQUENCY**

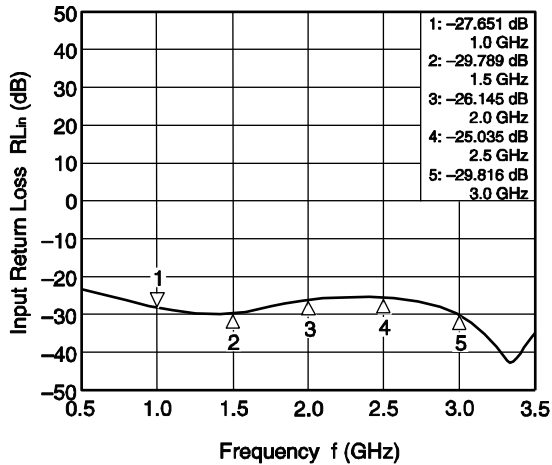

**INPUT-OUTPUT2
INPUT RETURN LOSS vs. FREQUENCY**

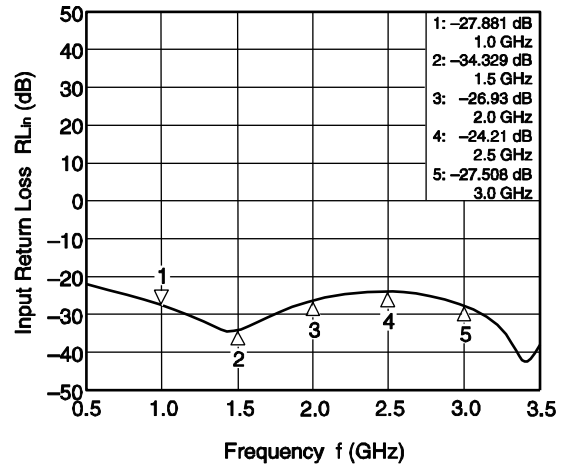

**INPUT-OUTPUT1
OUTPUT RETURN LOSS vs. FREQUENCY**

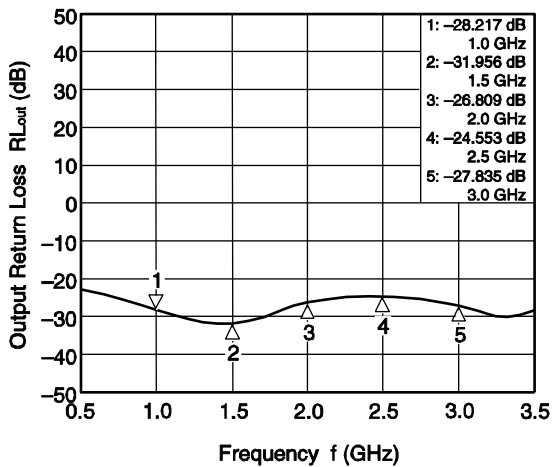

**INPUT-OUTPUT2
OUTPUT RETURN LOSS vs. FREQUENCY**

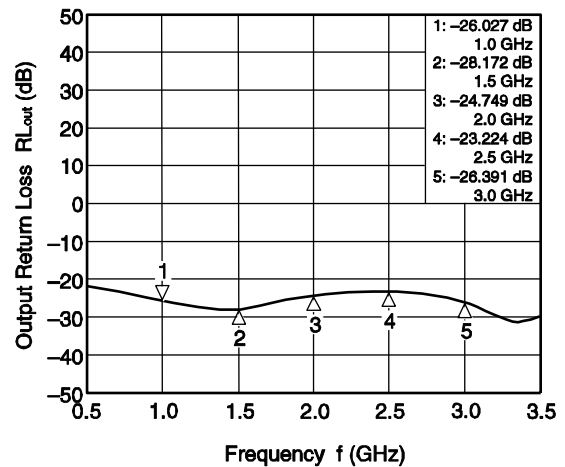

Remark The graphs indicate nominal characteristics.

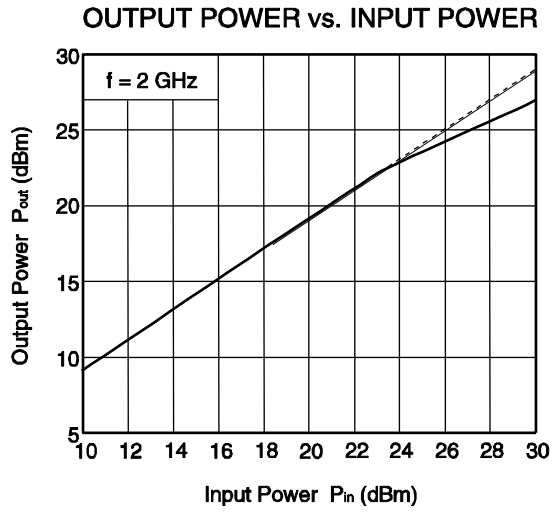

Remark The graph indicate nominal characteristics.

PACKAGE DIMENSIONS

6-PIN LEAD-LESS MINIMOLD (1511) (UNIT: mm)

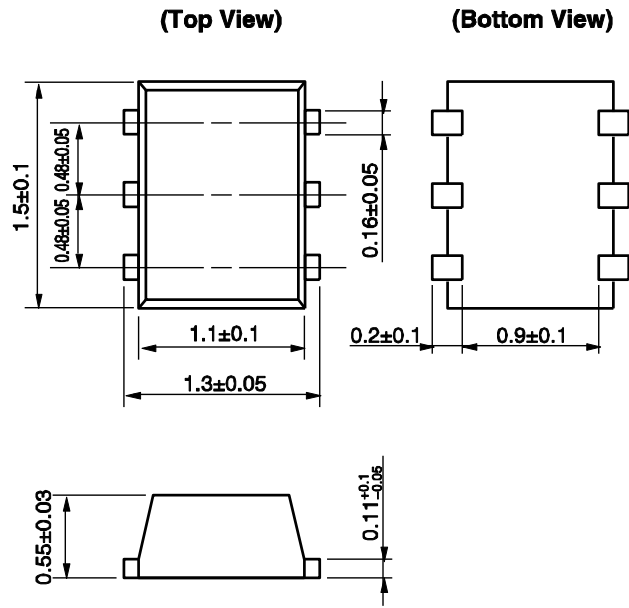

RECOMMENDED SOLDERING CONDITIONS

This product should be soldered and mounted under the following recommended conditions. For soldering methods and conditions other than those recommended below, contact your nearby sales office.

Soldering Method	Soldering Conditions	Condition Symbol
Infrared Reflow	Peak temperature (package surface temperature) : 260°C or below Time at peak temperature : 10 seconds or less Time at temperature of 220°C or higher : 60 seconds or less Preheating time at 120 to 180°C : 120±30 seconds Maximum number of reflow processes : 3 times Maximum chlorine content of rosin flux (% mass) : 0.2%(Wt.) or below	IR260
VPS	Peak temperature (package surface temperature) : 215°C or below Time at temperature of 200°C or higher : 25 to 40 seconds Preheating time at 120 to 150°C : 30 to 60 seconds Maximum number of reflow processes : 3 times Maximum chlorine content of rosin flux (% mass) : 0.2%(Wt.) or below	VP215
Wave Soldering	Peak temperature (molten solder temperature) : 260°C or below Time at peak temperature : 10 seconds or less Preheating temperature (package surface temperature) : 120°C or below Maximum number of flow processes : 1 time Maximum chlorine content of rosin flux (% mass) : 0.2%(Wt.) or below	WS260
Partial Heating	Peak temperature (pin temperature) : 350°C or below Soldering time (per side of device) : 3 seconds or less Maximum chlorine content of rosin flux (% mass) : 0.2%(Wt.) or below	HS350

Caution Do not use different soldering methods together (except for partial heating).

<p>Caution</p>	<p>GaAs Products</p>	<p>This product uses gallium arsenide (GaAs). GaAs vapor and powder are hazardous to human health if inhaled or ingested, so please observe the following points.</p> <ul style="list-style-type: none"> • Follow related laws and ordinances when disposing of the product. If there are no applicable laws and/or ordinances, dispose of the product as recommended below. <ol style="list-style-type: none"> 1. Commission a disposal company able to (with a license to) collect, transport and dispose of materials that contain arsenic and other such industrial waste materials. 2. Exclude the product from general industrial waste and household garbage, and ensure that the product is controlled (as industrial waste subject to special control) up until final disposal. • Do not burn, destroy, cut, crush, or chemically dissolve the product. • Do not lick the product or in any way allow it to enter the mouth.
-----------------------	----------------------	---



Компания «ЭлектроПласт» предлагает заключение долгосрочных отношений при поставках импортных электронных компонентов на взаимовыгодных условиях!

Наши преимущества:

- Оперативные поставки широкого спектра электронных компонентов отечественного и импортного производства напрямую от производителей и с крупнейших мировых складов;
- Поставка более 17-ти миллионов наименований электронных компонентов;
- Поставка сложных, дефицитных, либо снятых с производства позиций;
- Оперативные сроки поставки под заказ (от 5 рабочих дней);
- Экспресс доставка в любую точку России;
- Техническая поддержка проекта, помощь в подборе аналогов, поставка прототипов;
- Система менеджмента качества сертифицирована по Международному стандарту ISO 9001;
- Лицензия ФСБ на осуществление работ с использованием сведений, составляющих государственную тайну;
- Поставка специализированных компонентов (Xilinx, Altera, Analog Devices, Intersil, Interpoint, Microsemi, Aeroflex, Peregrine, Syfer, Eurofarad, Texas Instrument, Miteq, Cobham, E2V, MA-COM, Hittite, Mini-Circuits, General Dynamics и др.);

Помимо этого, одним из направлений компании «ЭлектроПласт» является направление «Источники питания». Мы предлагаем Вам помощь Конструкторского отдела:

- Подбор оптимального решения, техническое обоснование при выборе компонента;
- Подбор аналогов;
- Консультации по применению компонента;
- Поставка образцов и прототипов;
- Техническая поддержка проекта;
- Защита от снятия компонента с производства.



Как с нами связаться

Телефон: 8 (812) 309 58 32 (многоканальный)

Факс: 8 (812) 320-02-42

Электронная почта: org@eplast1.ru

Адрес: 198099, г. Санкт-Петербург, ул. Калинина, дом 2, корпус 4, литера А.