

DPDT SWITCH GaAs MMIC

■ GENERAL DESCRIPTION

The NJG1617K11 is a DPDT switch MMIC which features low insertion loss, high isolation, wide frequency range (0.1-over 6GHz) and low operating voltage from 2.7V.

Thin switch is suited for wireless LAN IEEE 802.11b/802.11g (2.4GHz band) and IEEE 802.11a (5GHz band).

The industrial standard QFN12-11 package is applied.

■ PACKAGE OUTLINE

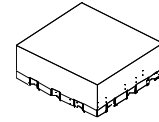

NJG1617K11

■ FEATURES

- Low voltage operation +2.7~+5.0V
- Pin at 0.2dB compression point +32dBm typ. @f=6.0GHz, $V_{CTL}=+3.0V$
- Low insertion loss 0.7dB typ. @f=2.5GHz
- High isolation 0.75dB typ. @f=6.0GHz
- Ultra small & ultra thin package 30dB typ. @f=2.5GHz
- Ultra small & ultra thin package 25dB typ. @f=6.0GHz
- Ultra small & ultra thin package QFN12-11 (Package size: 3.0x3.0x0.75mm)

■ PIN CONFIGURATION

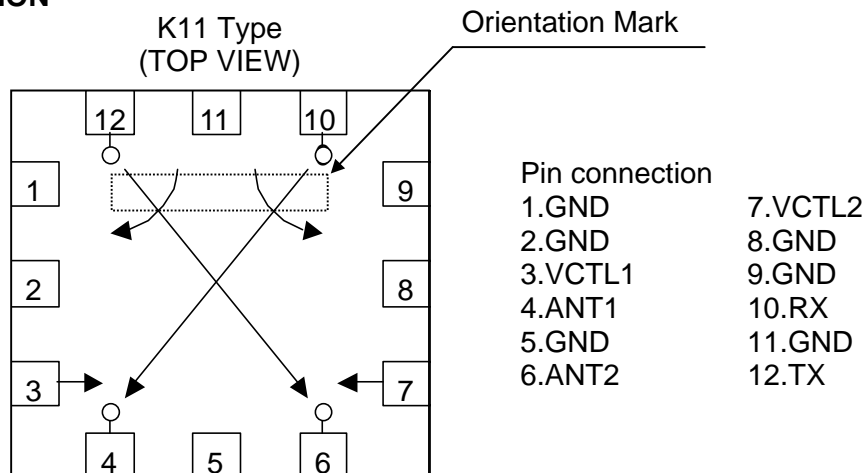

■ TRUTH TABLE

Control Voltage: "H" $=V_{CTL(H)}$, "L" $=V_{CTL(L)}$

| PASS | CONTROL SIGNAL | |
|--------------------|----------------|-------|
| | VCTL1 | VCTL2 |
| ANT1-TX ANT2-RX | L | H |
| ANT1-RX ANT2-TX | H | L |

NOTE: Please note that any data or drawing in this catalog is subject to change.

NJG1617K11

■ ABSOLUTE MAXIMUM RATINGS

(T_a=+25°C)

| PARAMETER | SYMBOL | CONDITIONS | RATINGS | UNITS |
|-----------------|------------------|----------------------------|----------|-------|
| RF Input Power | P _{IN} | V _{CTL} =0V/+3.0V | +33 | dBm |
| Control Voltage | V _{CTL} | V _{CTL} terminal | +7.5 | V |
| Operating Temp. | T _{opr} | | -40~+85 | °C |
| Storage Temp. | T _{stg} | | -55~+150 | °C |

■ ELECTRICAL CHARACTERISTICS

(General conditions: T_a=+25°C, Z_s=Z_l=50Ω, V_{CTL(L)}=0V, V_{CTL(H)}=+3.0V)

| PARAMETERS | SYMBOL | CONDITIONS | MIN | TYP | MAX | UNITS |
|-----------------------------------|---------------------|--|------|------|-----|-------|
| Control Voltage (LOW) | V _{CTL(L)} | | -0.2 | - | 0.2 | V |
| Control Voltage (HIGH) | V _{CTL(H)} | | 2.7 | 3.0 | 5.0 | V |
| Control Current | I _{CTL} | f=5.25GHz | - | 0.5 | 5.0 | μA |
| Insertion Loss 1 | LOSS1 | f=2.5GHz, Pin=20dBm | - | 0.7 | 0.9 | dB |
| Insertion Loss 2 | LOSS2 | f=6.0GHz, Pin=20dBm | - | 0.75 | 1.0 | dB |
| Isolation 1 | ISL1 | f=2.5GHz, Pin=20dBm TX,RX-ANT1,ANT2 | 25 | 30 | - | dB |
| Isolation 2 | ISL2 | f=6.0GHz, Pin=20dBm TX,RX-ANT1,ANT2 | 20 | 25 | - | dB |
| Pin at 0.2dB Compression Point | P _{-0.2dB} | f=5.25GHz | 29 | 32 | - | dBm |
| VSWR | VSWR | f=0.1~6.0GHz | - | 1.2 | 1.5 | |
| Switching Time | T _{SW} | f=0.1~6.0GHz | - | 20 | 100 | ns |

■ TERMINAL INFORMATION

| No. | SYMBOL | DESCRIPTION |
|------------------|--------|--|
| 3 | VCTL1 | Control signal input terminal. This terminal is set to High-Level (+2.7~+5.0V) or Low-Level (-0.2~+0.2V). |
| 4 | ANT1 | Antenna port. An external capacitor is required to block DC voltage. |
| 6 | ANT2 | Antenna port. An external capacitor is required to block DC voltage. |
| 7 | VCTL2 | Control signal input terminal. This terminal is set to High-Level (+2.7~+5.0V) or Low-Level (-0.2~+0.2V). |
| 10 | RX | RF receiving port. An external capacitor is required to block DC voltage. |
| 12 | TX | RF transmitting port. An external capacitor is required to block DC voltage. |
| 1,2,5,8, 9,11 | GND | Ground terminal. Please connect this terminal with ground plane as close as possible for excellent RF performance. |

NJG1617K11

■ ELECTRICAL CHARACTERISTICS

(With application circuit, Losses of Blocking Capacitor, and external circuit are excluded)

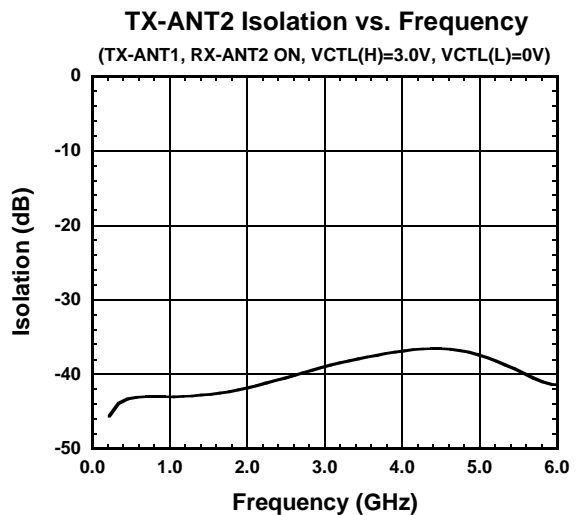
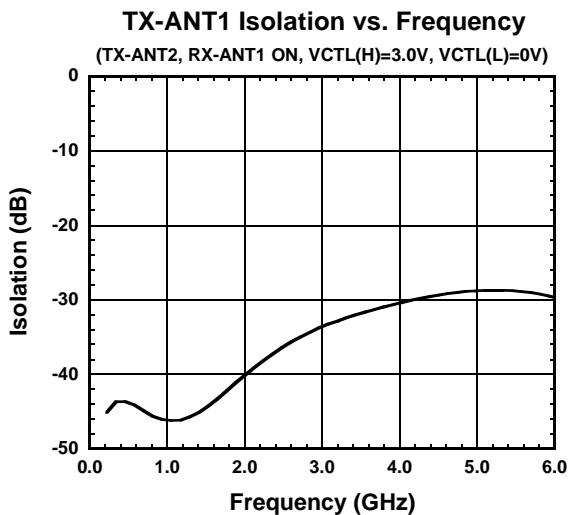
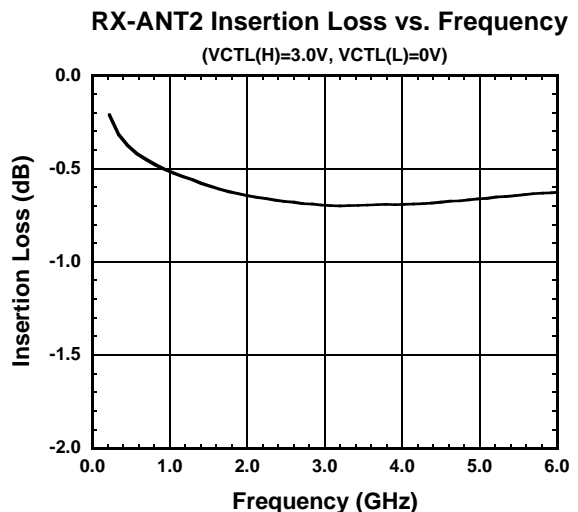
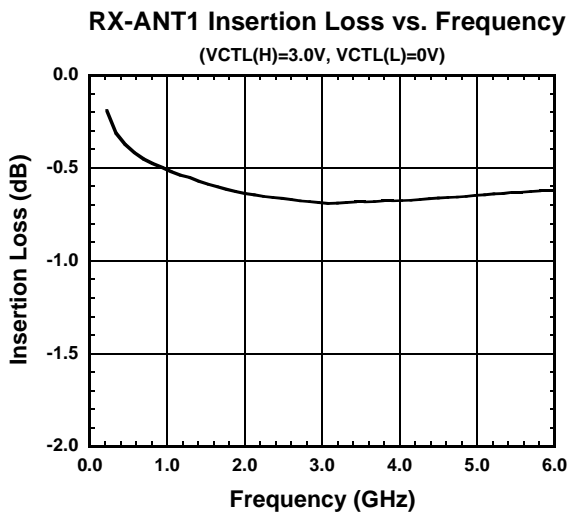
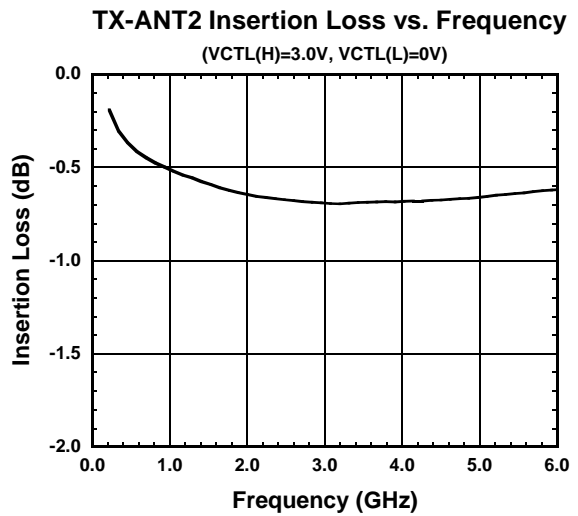
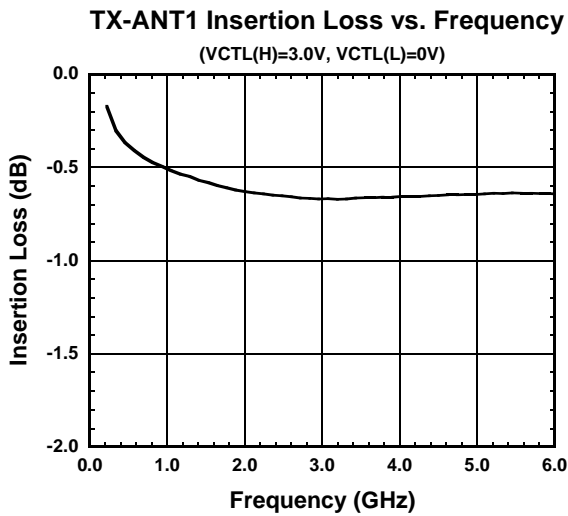

■ ELECTRICAL CHARACTERISTICS

(With application circuit, Losses of Blocking Capacitor, and external circuit are excluded)

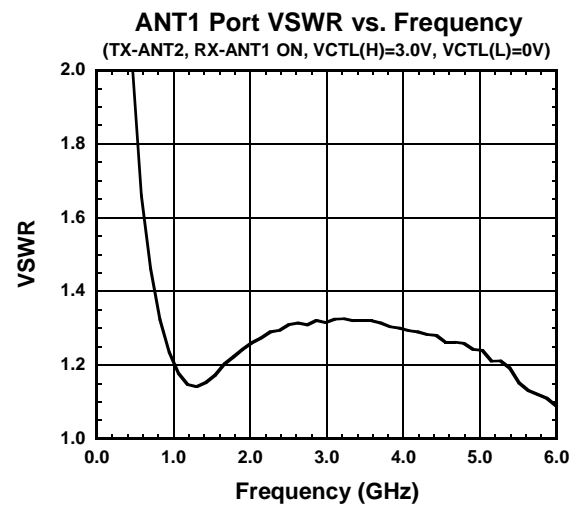
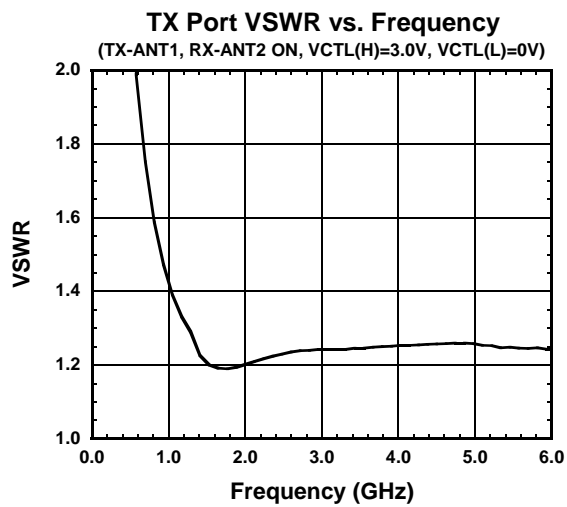
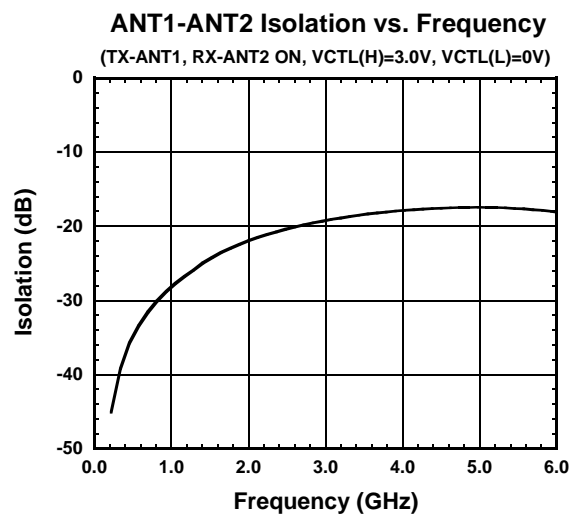
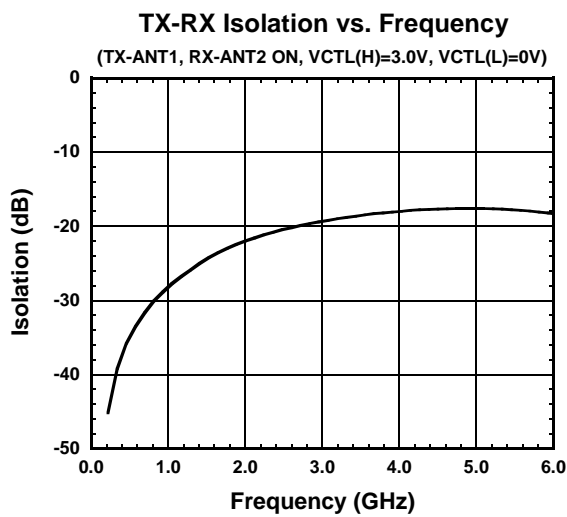
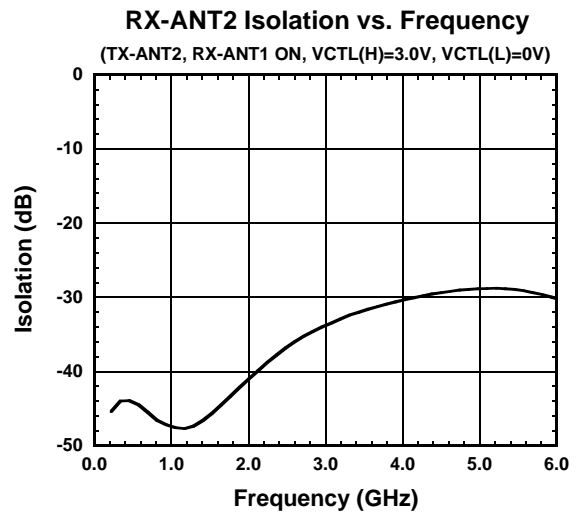
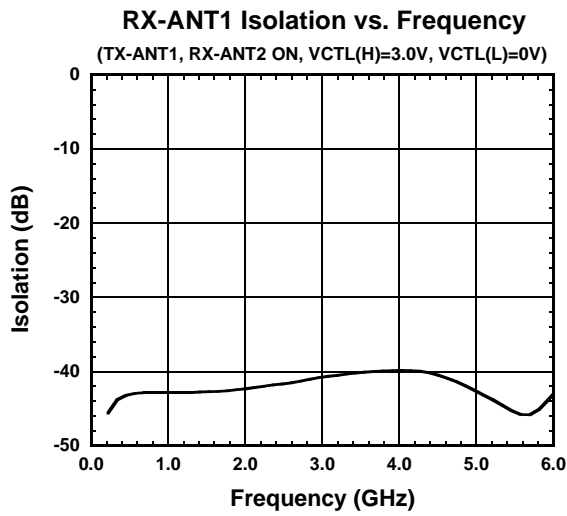

NJG1617K11

■ ELECTRICAL CHARACTERISTICS

(With application circuit, Losses of Blocking Capacitor, and external circuit are excluded)

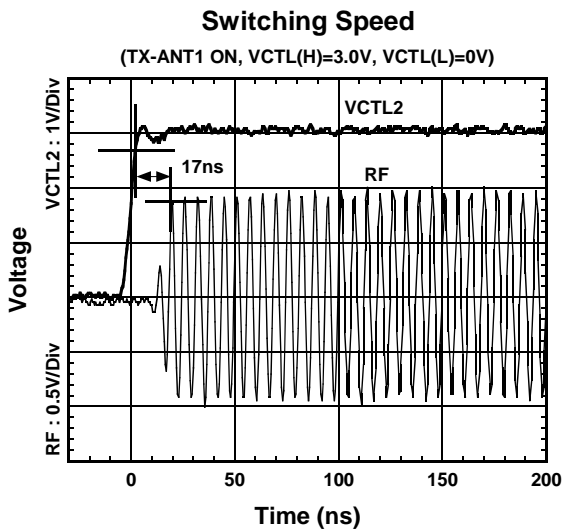
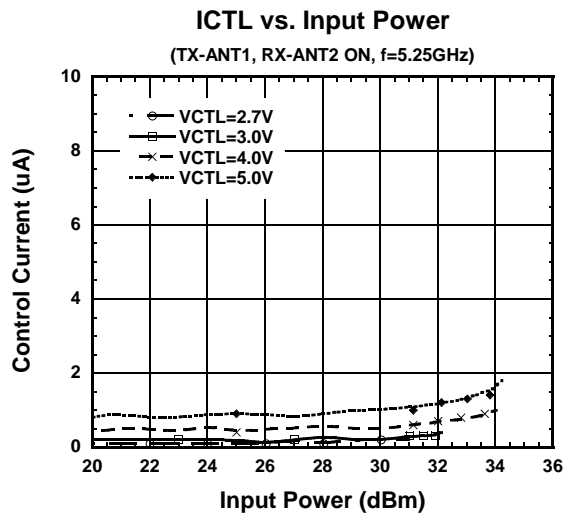
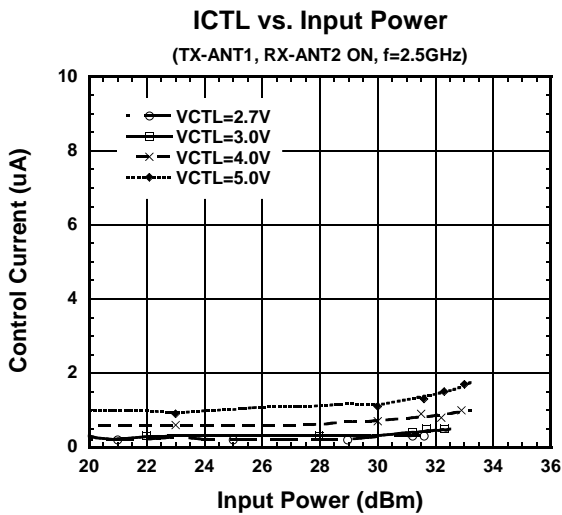
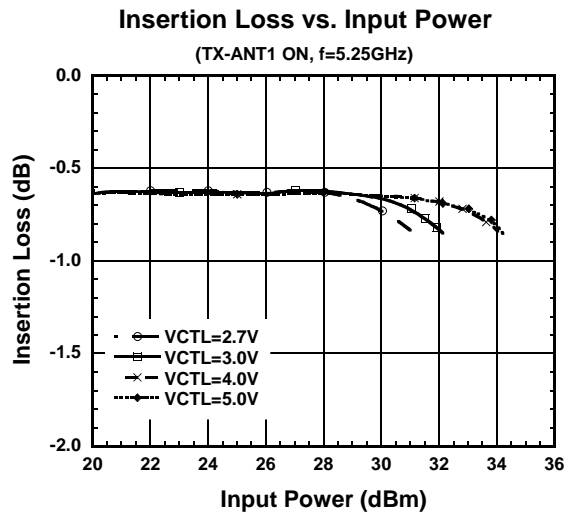
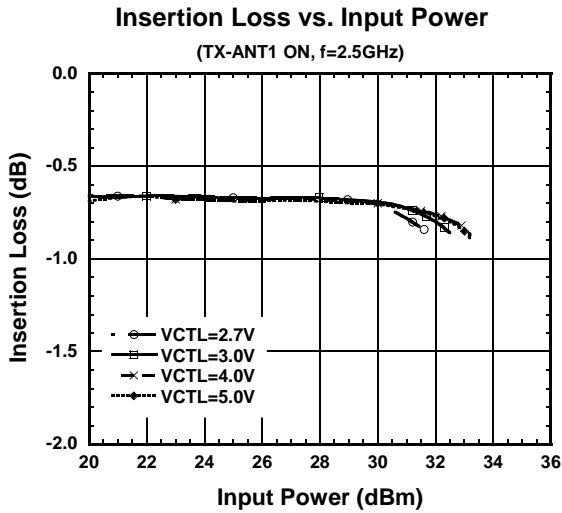

APPLICATION CIRCUIT

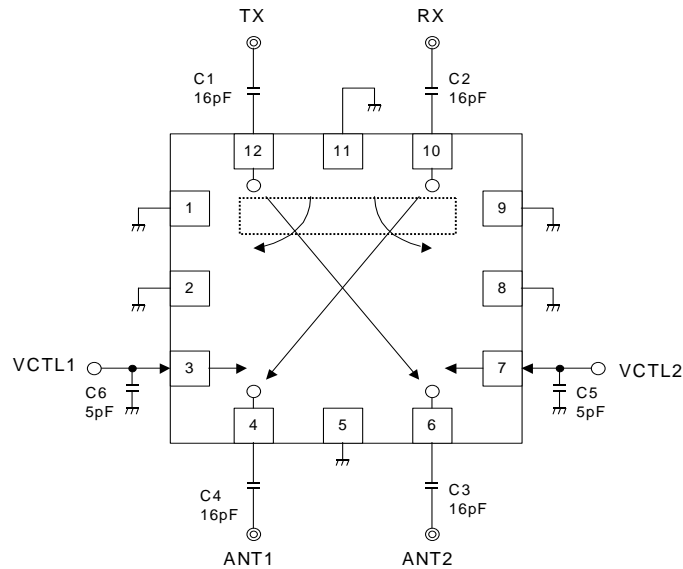

RECOMMENDED PCB DESIGN

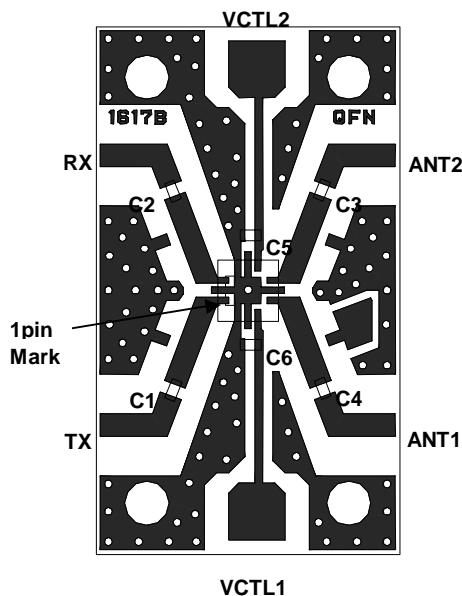

Total Losses of PCB, connector and DC blocking capacitor.

| f | PPE | FR-4 |
|--------|--------|--------|
| 2.5GHz | 0.20dB | 0.31dB |
| 6.0GHz | 0.41dB | 0.67dB |

PCB: PPE, t=0.5mm
Capacitor: size 1005
Strip line Width=1.1mm

PCB: FR4, t=0.5mm
Capacitor: size 1005
Strip line Width=1.0mm

PARTS LIST

| Parts | List 1 | List 2 | Notes |
|-------|------------|------------|--------------|
| | 0.1~2.0GHz | 2.0~6.0GHz | |
| C1~C4 | 39pF | 16pF | MURATA GRM15 |
| C5~C6 | 10pF | 5pF | MURATA GRM15 |

PRECAUTIONS

- [1]The DC blocking capacitors have to be placed at RF terminal of RX, TX, ANT1 and ANT2.
- [2] Please locate bypass capacitors (C5,C6) close to appropriate terminals to reduce stripline influence on RF characteristics.
- [3]For good RF performance, the GND terminal must be placed close to ground plane of substrate, and through holes for GND should be placed near by the GND pin connection.
- [4]Exposed pad in the bottom must be connected to ground by via holes.

NJG1617K11

PACKAGE OUTLINE

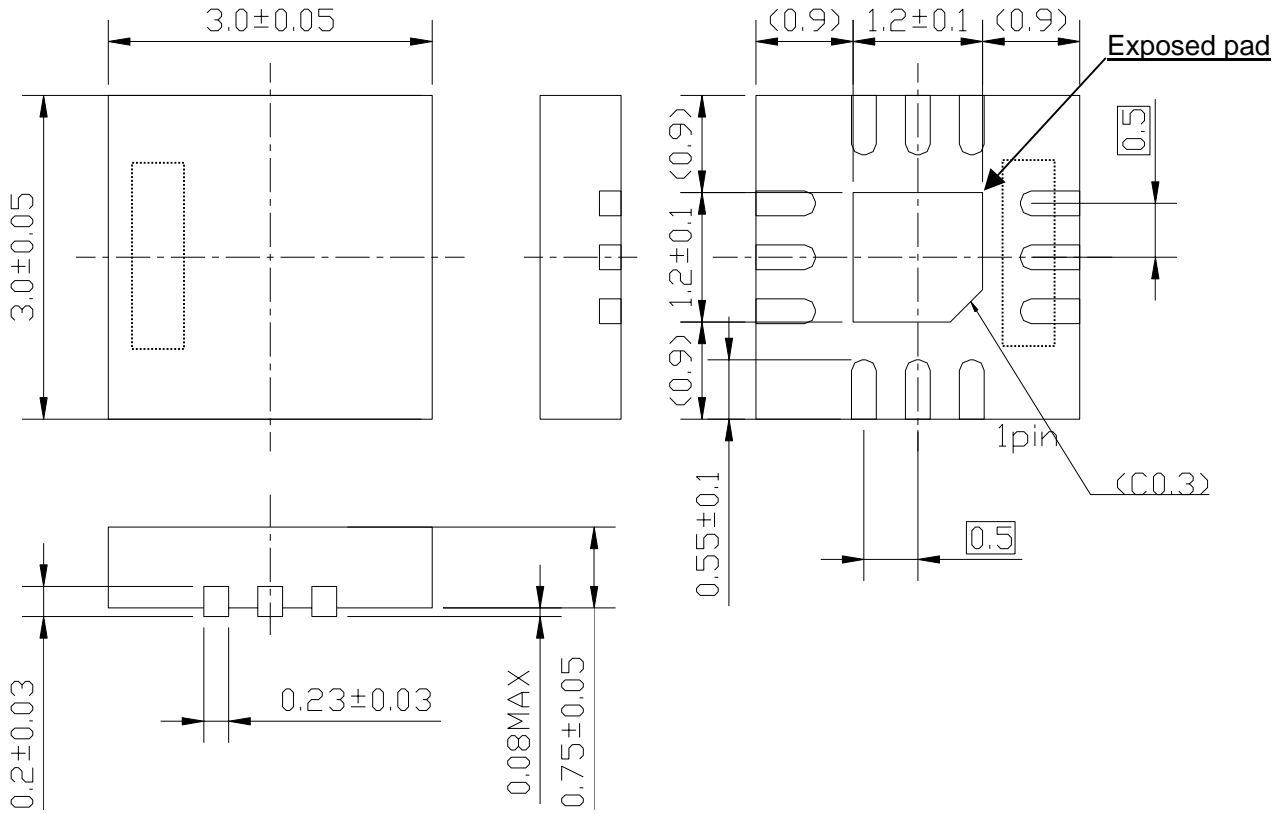

TERMINAL TREAT : Bi-Sn
 Molding material : Epoxy resin
 UNIT : mm
 WEIGHT : 20mg

Cautions on using this product

- This product contains Gallium-Arsenide (GaAs) which is a harmful material.
- Do NOT eat or put into mouth.
 - Do NOT dispose in fire or break up this product.
 - Do NOT chemically make gas or powder with this product.
 - To waste this product, please obey the relating law of your country.

[CAUTION]

The specifications on this databook are only given for information, without any guarantee as regards either mistakes or omissions. The application circuits in this databook are described only to show representative usages of the product and not intended for the guarantee or permission of any right including the industrial rights.

This product may be damaged with electric static discharge (ESD) or spike voltage. Please handle with care to avoid these damages.



Компания «ЭлектроПласт» предлагает заключение долгосрочных отношений при поставках импортных электронных компонентов на взаимовыгодных условиях!

Наши преимущества:

- Оперативные поставки широкого спектра электронных компонентов отечественного и импортного производства напрямую от производителей и с крупнейших мировых складов;
- Поставка более 17-ти миллионов наименований электронных компонентов;
- Поставка сложных, дефицитных, либо снятых с производства позиций;
- Оперативные сроки поставки под заказ (от 5 рабочих дней);
- Экспресс доставка в любую точку России;
- Техническая поддержка проекта, помощь в подборе аналогов, поставка прототипов;
- Система менеджмента качества сертифицирована по Международному стандарту ISO 9001;
- Лицензия ФСБ на осуществление работ с использованием сведений, составляющих государственную тайну;
- Поставка специализированных компонентов (Xilinx, Altera, Analog Devices, Intersil, Interpoint, Microsemi, Aeroflex, Peregrine, Syfer, Eurofarad, Texas Instrument, Miteq, Cobham, E2V, MA-COM, Hittite, Mini-Circuits, General Dynamics и др.);

Помимо этого, одним из направлений компании «ЭлектроПласт» является направление «Источники питания». Мы предлагаем Вам помощь Конструкторского отдела:

- Подбор оптимального решения, техническое обоснование при выборе компонента;
- Подбор аналогов;
- Консультации по применению компонента;
- Поставка образцов и прототипов;
- Техническая поддержка проекта;
- Защита от снятия компонента с производства.



Как с нами связаться

Телефон: 8 (812) 309 58 32 (многоканальный)

Факс: 8 (812) 320-02-42

Электронная почта: org@eplast1.ru

Адрес: 198099, г. Санкт-Петербург, ул. Калинина, дом 2, корпус 4, литера А.