

LEB100F

LEB 100 F -05 24 -□

① ② ③ ④ ⑤ ⑥

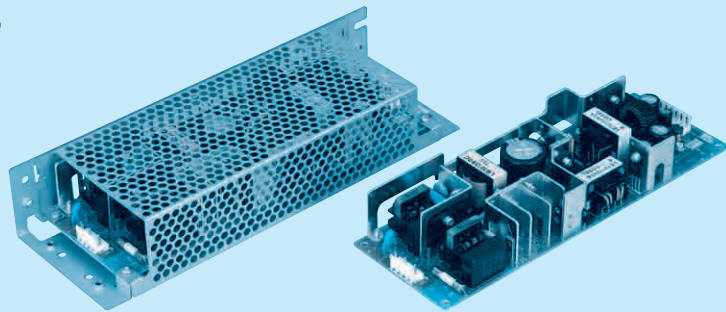

Recommended EMI/EMC Filter
NAC-06-472



High voltage pulse noise type : NAP series
Low leakage current type : NAM series
*The EMI/EMC Filter is recommended to connect with several devices.

- ① Series name
- ② Output wattage
- ③ Universal input
- ④ V1 Output voltage
- ⑤ V2 Output voltage
- ⑥ Optional *1 *8
- G :Low leakage current
- R :with Remote ON/OFF
- S :with Chassis
- SN :with Chassis & cover
- T :Vertical terminal block
- Y :with Potentiometer
- Z :with ZT

| MODEL | LEB100F-0512 | LEB100F-0324 | LEB100F-0524 | LEB100F-0530 | LEB100F-0536 |
|-----------|--------------|------------------|-----------------|-----------------|---------------------|
| DC OUTPUT | V1 | +5V 5A | +3.3V 5A | +5V 5A | +5V 5A |
| | V2 | +12V 5(Peak 10)A | +24V 4(Peak 7)A | +24V 4(Peak 7)A | +30V 3.2(Peak 5.6)A |

SPECIFICATIONS

| | MODEL | LEB100F-0512 | LEB100F-0324 | LEB100F-0524 | LEB100F-0530 | LEB100F-0536 | | | | | | |
|------------------------------|--|--|--|--|-----------------|-----------------|-----------------|----------------|--------------------|----------------|--------------------|--------|
| INPUT | VOLTAGE[V] | AC85 - 264 1 φ or DC 120 - 370 | | | | | | | | | | |
| | CURRENT[A] | ACIN 100V | 1.2typ (Io=100%) | 1.4typ (Io=100%) | | | | | | | | |
| | | ACIN 200V | 0.6typ (Io=100%) | 0.7typ (Io=100%) | | | | | | | | |
| | FREQUENCY[Hz] | 50/60 (47 - 63) or DC | | | | | | | | | | |
| | EFFICIENCY[%] | ACIN 100V | 74typ (Io=100%) | 78typ (Io=100%) | 78typ (Io=100%) | 78typ (Io=100%) | 78typ (Io=100%) | | | | | |
| | | ACIN 200V | 76typ (Io=100%) | 80typ (Io=100%) | 80typ (Io=100%) | 80typ (Io=100%) | 80typ (Io=100%) | | | | | |
| | POWER FACTOR | ACIN 100V | 0.98typ | 0.99typ | | | | | | | | |
| | | ACIN 200V | 0.93typ | | | | | | | | | |
| | INRUSH CURRENT[A] | ACIN 100V | 15typ (Io=100%) (At cold start) (Ta=25°C) | | | | | | | | | |
| | | ACIN 200V | 30typ (Io=100%) (At cold start) (Ta=25°C) | | | | | | | | | |
| LEAKAGE CURRENT[mA] | 0.75max (60Hz, According to IEC60950 and DEN-AN) | | | | | | | | | | | |
| OUTPUT | VOLTAGE[V] | +5 | +12 | +3.3 | +24 | +5 | +30 | +5 | +36 | | | |
| | CURRENT[A] | *2 0 - 5 | 0 - 5 (Peak 10) | 0 - 5 | 0 - 4 (Peak 7) | 0 - 5 | 0 - 4 (Peak 7) | 0 - 5 | 0 - 3.2 (Peak 5.6) | 0 - 5 | 0 - 2.7 (Peak 4.7) | |
| | TOTAL OUTPUT WATTAGE[W] | *3 85 (Peak 145) | | 100 (Peak 172) | | 100 (Peak 172) | | 100 (Peak 172) | | 100 (Peak 172) | | |
| | LINE REGULATION[mV] | 20max | 48max | 20max | 96max | 20max | 96max | 20max | 120max | 20max | 144max | |
| | | 40max | 100max | 40max | 150max | 40max | 150max | 40max | 180max | 40max | 180max | |
| | LOAD REGULATION[mV] | 80max | 120max | 80max | 120max | 80max | 120max | 80max | 200max | 80max | 200max | |
| | | 140max | 160max | 140max | 160max | 140max | 160max | 140max | 240max | 140max | 240max | |
| | RIPPLE[mVp-p] | 0 to +50°C *4 | 80max | 120max | 80max | 120max | 80max | 120max | 80max | 200max | 80max | 200max |
| | | -10 - 0°C *4 | 140max | 160max | 140max | 160max | 140max | 160max | 140max | 240max | 140max | 240max |
| | RIPPLE NOISE[mVp-p] | 0 to +50°C *4 | 120max | 150max | 120max | 150max | 120max | 150max | 120max | 300max | 120max | 300max |
| | | -10 - 0°C *4 | 160max | 180max | 160max | 180max | 160max | 180max | 160max | 360max | 160max | 360max |
| | TEMPERATURE REGULATION[mV] | 0 to +50°C | 50max | 120max | 50max | 240max | 50max | 240max | 50max | 300max | 50max | 300max |
| | | -10 to +50°C | 60max | 150max | 60max | 290max | 60max | 290max | 60max | 350max | 60max | 350max |
| | DRIFT[mV] | *5 20max | 48max | 20max | 96max | 20max | 96max | 20max | 120max | 20max | 144max | |
| | START-UP TIME[ms] | *6 250max | 500max | 250max | 500max | 250max | 500max | 250max | 500max | 250max | 500max | |
| | HOLD-UP TIME[ms] | *6 40typ | 20typ | 40typ | 20typ | 40typ | 20typ | 40typ | 20typ | 40typ | 20typ | |
| | OUTPUT VOLTAGE ADJUSTMENT RANGE[V] | 4.5 - 5.5 | Fixed | 2.85 - 3.60 | Fixed | 4.5 - 5.5 | Fixed | 4.5 - 5.5 | Fixed | 4.5 - 5.5 | Fixed | |
| | OUTPUT VOLTAGE SETTING[V] | — | 11.5 - 12.5 | — | 23.0 - 25.0 | — | 23.0 - 25.0 | — | 28.7 - 31.5 | — | 34.5 - 37.5 | |
| | PROTECTION CIRCUIT AND OTHERS | OVERCURRENT PROTECTION | V1 | Works over 105% of rating current and recovers automatically | | | | | | | | |
| V2 | | | Works over 101% of peak current and recovers automatically | | | | | | | | | |
| OVERVOLTAGE PROTECTION | | V1 | Works over 115% of rating, by zener diode clamping | | | | | | | | | |
| | | V2 | Works at 115 - 140% of rating | | | | | | | | | |
| REMOTE ON/OFF | Option (Refer to Instruction Manual) | | | | | | | | | | | |
| ISOLATION | INPUT-OUTPUT · RC | *7 AC3.000V 1minute, Cutoff current = 10mA, DC500V 50MΩ min (At Room Temperature) | | | | | | | | | | |
| | INPUT-FG | AC2.000V 1minute, Cutoff current = 10mA, DC500V 50MΩ min (At Room Temperature) | | | | | | | | | | |
| | OUTPUT · RC-FG | *7 AC500V 1minute, Cutoff current = 100mA, DC500V 50MΩ min (At Room Temperature) | | | | | | | | | | |
| | OUTPUT-OUTPUT(V1 · RC-V2) *7 | AC100V 1minute, Cutoff current = 100mA, DC100V 10MΩ min (At Room Temperature) | | | | | | | | | | |
| ENVIRONMENT | OPERATING TEMP.HUMID.AND ALTITUDE | -10 to +70°C, 20 - 90%RH (Non condensing) (Refer to DERATING CURVE), 3,000m (10,000feet) max | | | | | | | | | | |
| | STORAGE TEMP.HUMID.AND ALTITUDE | -20 to +75°C, 20 - 90%RH (Non condensing), 9,000m (30,000feet) max | | | | | | | | | | |
| | VIBRATION | 10 - 55Hz, 19.6m/s ² (2G), 3minutes period, 60minutes each along X, Y and Z axis | | | | | | | | | | |
| | IMPACT | 196.1m/s ² (20G), 11ms, once each X, Y and Z axis | | | | | | | | | | |
| SAFETY AND NOISE REGULATIONS | AGENCY APPROVALS | UL60950-1, C-UL, EN60950-1, EN50178 Complies with DEN-AN and IEC60950-1 (At only AC input) | | | | | | | | | | |
| | CONDUCTED NOISE | Complies with FCC-B, CISPR22-B, EN55022-B, VCCI-B | | | | | | | | | | |
| | HARMONIC ATTENUATOR | Complies with IEC61000-3-2 *9 | | | | | | | | | | |
| OTHERS | CASE SIZE/WEIGHT | 75 x 35 x 222mm [2.95 x 1.38 x 8.74 inches] /420g max (with chassis & cover : 690g max) | | | | | | | | | | |
| | COOLING METHOD | Convection | | | | | | | | | | |

*1 Specification is changed at option, refer to Instruction Manual 5.
 *2 Peak loading for 10sec. And Duty 35% max, refer to Instruction Manual 4. In detail.
 *3 Refer to Instruction Manual 2.2 in detail.
 *4 This is the value that measured on measuring board with capacitor of 22 μF within 150mm from output terminal. Measured by 20MHz oscilloscope or Ripple-Noise meter (Equivalent to KEISOKU-GIKEN: RM101).
 *5 Drift is the change in DC output for an eight hour period after a half-hour warm-up at 25°C, with the input voltage held constant at the rated input/output.

*6 ACIN 100V, Io=100%
 *7 Applicable when remote control (optional) is added.
 *8 Please contact us about safety approvals for the model with option.
 *9 Please contact us about class C.
 * Series/Parallel operation is not possible.
 * Derating is required when operated with chassis and cover.
 * A sound may occur from power supply at peak loading.

External view

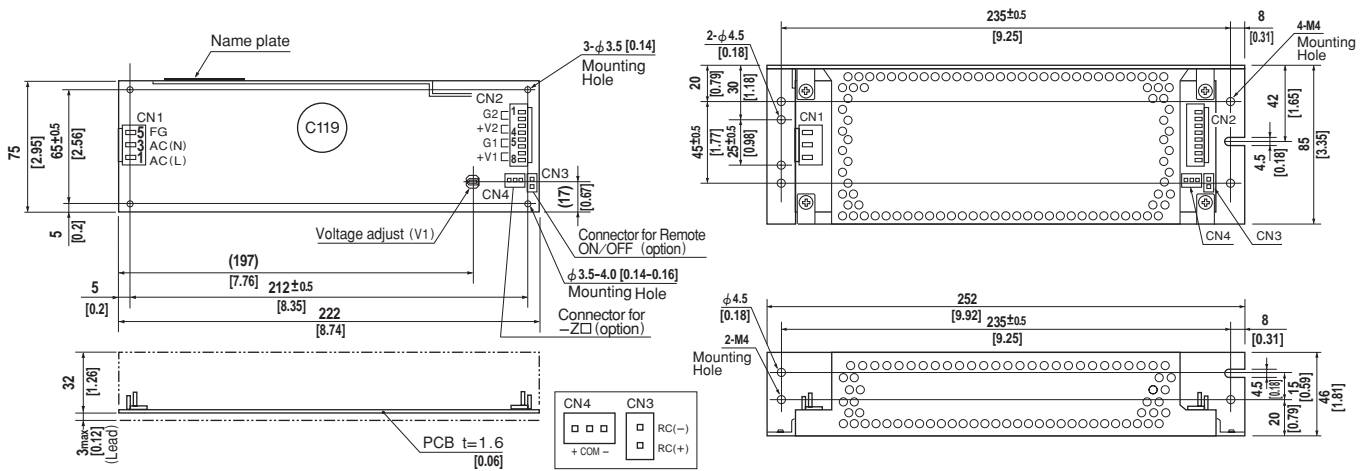

| I / O Connector | Mating Connector | Terminal |
|---------------------|------------------|----------|
| CN1 | B3P5-VH | VHR-5N |
| CN2 | B8P-VH | VHR-8N |
| CN3 (Option) | B2B-XH-A | XHP-2 |
| CN4 (Option) | B3B-XH-A | XHP-3 |

CN1

| Pin No. | Input |
|---------|-------|
| 1 | AC(L) |
| 2 | |
| 3 | AC(N) |
| 4 | |
| 5 | FG |

(PIN CONNECTION)

CN2

| Pin No. | Output |
|---------|--------|
| 1, 2 | G 2 |
| 3, 4 | V 2 |
| 5, 6 | G 1 |
| 7, 8 | V 1 |

CN3 (Option)

| Pin No. | Remote ON/OFF |
|---------|---------------|
| 1 | RC(+) |
| 2 | RC(-) |

CN4 (Option)

| Pin No. | -Z□ |
|---------|-----|
| 1 | + |
| 2 | COM |
| 3 | - |

(Mfr: J.S.T.)

※Keep drawing current per pin below 5A for CN2

- ※Weight: 420g max
(with chassis & cover : 690g max)
- ※Tolerance: ±1 [±0.04]
- ※Dimensions in mm, [] = inches
- ※PCB Material : CEM3
- ※Chassis and cover is optional.
- ※Mounting torque: 1.5N·m(16kgf·cm)max

Performance data

RISE TIME & FALL TIME (LEB100F-0524)

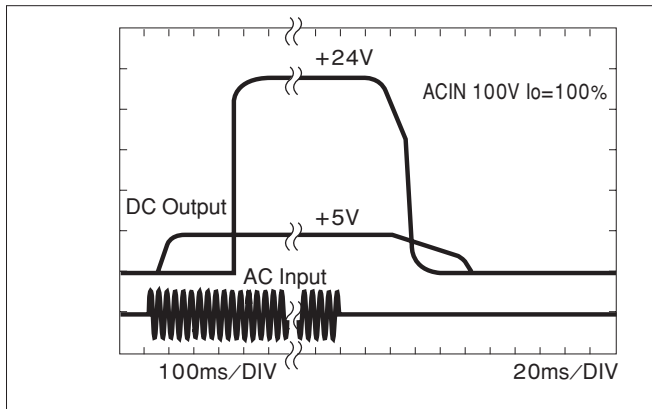

EFFICIENCY (LEB100F-0524)

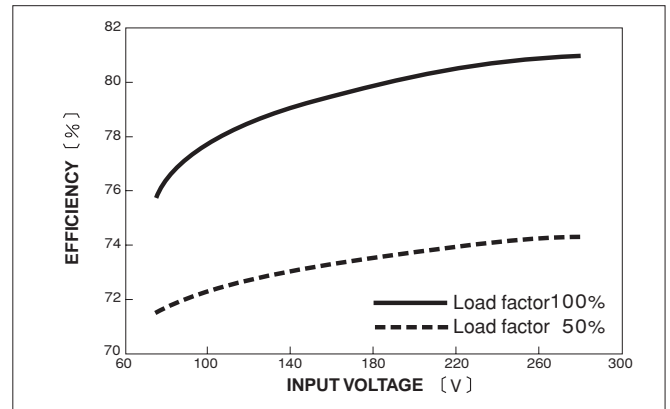

INPUT HARMONIC CURRENT (LEB100F-0524)

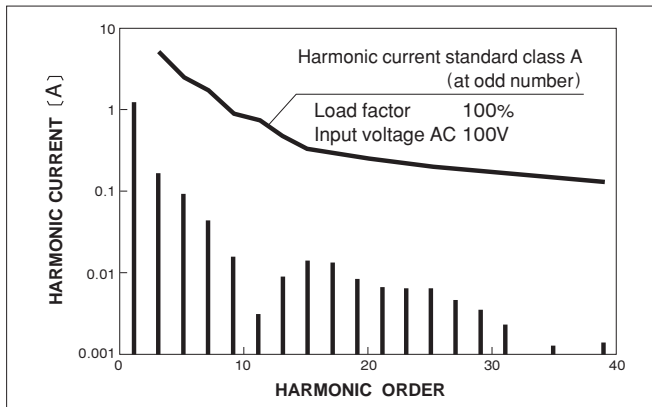

INPUT HARMONIC CURRENT (LEB100F-0524)

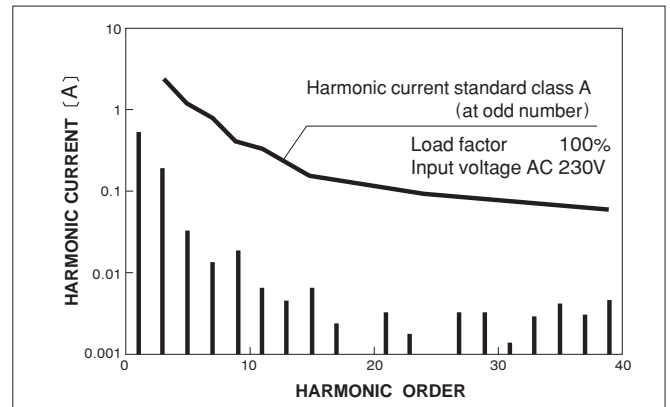

LEB150F

LEB 150 F -05 24 -□

① ② ③ ④ ⑤ ⑥



Recommended EMI/EMC Filter
NAC-06-472



High voltage pulse noise type : NAP series
Low leakage current type : NAM series
*The EMI/EMC Filter is recommended to connect with several devices.

- ① Series name
- ② Output wattage
- ③ Universal input
- ④ V1 Output voltage
- ⑤ V2 Output voltage
- ⑥ Optional *1 *8
- G : Low leakage current
- R : with Remote ON/OFF
- S : with Chassis
- SN : with Chassis & cover
- T : Vertical terminal block
- Y : with Potentiometer
- Z : with ZT

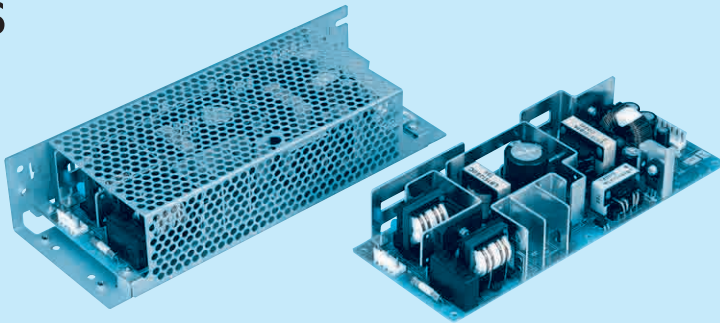

| MODEL | LEB150F-0512 | LEB150F-0324 | LEB150F-0524 | LEB150F-0530 | LEB150F-0536 |
|-----------|--------------|--------------------|------------------|------------------|-------------------|
| DC OUTPUT | V1 | +5V 5A | +3.3V 5A | +5V 5A | +5V 5A |
| | V2 | +12V 7.5(Peak 14)A | +24V 6(Peak 10)A | +24V 6(Peak 10)A | +30V 4.8(Peak 8)A |

SPECIFICATIONS

| | MODEL | LEB150F-0512 | LEB150F-0324 | LEB150F-0524 | LEB150F-0530 | LEB150F-0536 | | | | | | |
|------------------------------------|--|---|--|------------------|-----------------|-----------------|-----------------|----------------|------------------|----------------|------------------|--------|
| INPUT | VOLTAGE[V] | AC85 - 264 1 φ or DC 120 - 370 | | | | | | | | | | |
| | CURRENT[A] | ACIN 100V | 1.6typ (Io=100%) | 2.0typ (Io=100%) | | | | | | | | |
| | | ACIN 200V | 0.8typ (Io=100%) | 1.0typ (Io=100%) | | | | | | | | |
| | FREQUENCY[Hz] | 50/60 (47 - 63) or DC | | | | | | | | | | |
| | EFFICIENCY[%] | ACIN 100V | 76typ (Io=100%) | 79typ (Io=100%) | 79typ (Io=100%) | 79typ (Io=100%) | 79typ (Io=100%) | | | | | |
| | | ACIN 200V | 79typ (Io=100%) | 82typ (Io=100%) | 82typ (Io=100%) | 82typ (Io=100%) | 82typ (Io=100%) | | | | | |
| | POWER FACTOR | ACIN 100V | 0.98typ | 0.99typ | | | | | | | | |
| | | ACIN 200V | 0.93typ | | | | | | | | | |
| INRUSH CURRENT[A] | ACIN 100V | 15typ (Io=100%) (At cold start) (Ta=25°C) | | | | | | | | | | |
| | ACIN 200V | 30typ (Io=100%) (At cold start) (Ta=25°C) | | | | | | | | | | |
| LEAKAGE CURRENT[mA] | 0.75max (60Hz, According to IEC60950 and DEN-AN) | | | | | | | | | | | |
| OUTPUT | VOLTAGE[V] | +5 | +12 | +3.3 | +24 | +5 | +24 | +5 | +30 | +5 | +36 | |
| | CURRENT[A] | *2 0 - 5 | 0 - 7.5 (Peak 14) | 0 - 5 | 0 - 6 (Peak 10) | 0 - 5 | 0 - 6 (Peak 10) | 0 - 5 | 0 - 4.8 (Peak 8) | 0 - 5 | 0 - 4 (Peak 6.7) | |
| | TOTAL OUTPUT WATTAGE[W] | *3 115 (Peak 193) | | 150 (Peak 246) | | 150 (Peak 246) | | 150 (Peak 246) | | 150 (Peak 246) | | |
| | LINE REGULATION[mV] | 40max | 48max | 20max | 96max | 20max | 96max | 20max | 120max | 20max | 144max | |
| | | 40max | 100max | 40max | 150max | 40max | 150max | 40max | 180max | 40max | 180max | |
| | LOAD REGULATION[mV] | 80max | 120max | 80max | 120max | 80max | 120max | 80max | 200max | 80max | 200max | |
| | | 140max | 160max | 140max | 160max | 140max | 160max | 140max | 240max | 140max | 240max | |
| | RIPPLE[mVp-p] | 0 to +45°C *4 | 80max | 120max | 80max | 120max | 80max | 120max | 80max | 200max | 80max | 200max |
| | | -10 - 0°C *4 | 140max | 160max | 140max | 160max | 140max | 160max | 140max | 240max | 140max | 240max |
| | RIPPLE NOISE[mVp-p] | 0 to +45°C *4 | 120max | 150max | 120max | 150max | 120max | 150max | 120max | 300max | 120max | 300max |
| | | -10 - 0°C *4 | 160max | 180max | 160max | 180max | 160max | 180max | 160max | 360max | 160max | 360max |
| | TEMPERATURE REGULATION[mV] | 0 to +45°C | 50max | 120max | 50max | 240max | 50max | 240max | 50max | 300max | 50max | 300max |
| | | -10 to +45°C | 60max | 150max | 60max | 290max | 60max | 290max | 60max | 350max | 60max | 350max |
| | DRIFT[mV] | *5 | 20max | 48max | 20max | 96max | 20max | 96max | 20max | 120max | 20max | 144max |
| | START-UP TIME[ms] | *6 | 250max | 500max | 250max | 500max | 250max | 500max | 250max | 500max | 250max | 500max |
| HOLD-UP TIME[ms] | *6 | 40typ | 20typ | 40typ | 20typ | 40typ | 20typ | 40typ | 20typ | 40typ | 20typ | |
| OUTPUT VOLTAGE ADJUSTMENT RANGE[V] | | 4.5 - 5.5 | Fixed | 2.85 - 3.60 | Fixed | 4.5 - 5.5 | Fixed | 4.5 - 5.5 | Fixed | 4.5 - 5.5 | Fixed | |
| OUTPUT VOLTAGE SETTING[V] | | — | 11.5 - 12.5 | — | 23.0 - 25.0 | — | 23.0 - 25.0 | — | 28.7 - 31.5 | — | 34.5 - 37.5 | |
| PROTECTION CIRCUIT AND OTHERS | OVERCURRENT PROTECTION | V1 | Works over 105% of rating current and recovers automatically | | | | | | | | | |
| | | V2 | Works over 101% of peak current and recovers automatically | | | | | | | | | |
| | OVERVOLTAGE PROTECTION | V1 | Works over 115% of rating, by zener diode clamping | | | | | | | | | |
| | | V2 | Works at 115 - 140% of rating | | | | | | | | | |
| REMOTE ON/OFF | Option (Refer to Instruction Manual) | | | | | | | | | | | |
| ISOLATION | INPUT-OUTPUT · RC | *7 | AC3.000V 1minute, Cutoff current = 10mA, DC500V 50MΩ min (At Room Temperature) | | | | | | | | | |
| | INPUT-FG | AC2.000V 1minute, Cutoff current = 10mA, DC500V 50MΩ min (At Room Temperature) | | | | | | | | | | |
| | OUTPUT · RC-FG | *7 | AC500V 1minute, Cutoff current = 100mA, DC500V 50MΩ min (At Room Temperature) | | | | | | | | | |
| | OUTPUT-OUTPUT(V1 · RC-V2) | *7 | AC100V 1minute, Cutoff current = 100mA, DC100V 10MΩ min (At Room Temperature) | | | | | | | | | |
| ENVIRONMENT | OPERATING TEMP.HUMID.AND ALTITUDE | -10 to +70°C, 20 - 90%RH (Non condensing) (Refer to DERATING CURVE), 3,000m (10,000feet) max | | | | | | | | | | |
| | STORAGE TEMP.HUMID.AND ALTITUDE | -20 to +75°C, 20 - 90%RH (Non condensing), 9,000m (30,000feet) max | | | | | | | | | | |
| | VIBRATION | 10 - 55Hz, 19.6m/s ² (2G), 3minutes period, 60minutes each along X, Y and Z axis | | | | | | | | | | |
| | IMPACT | 196.1m/s ² (20G), 11ms, once each X, Y and Z axis | | | | | | | | | | |
| SAFETY AND NOISE REGULATIONS | AGENCY APPROVALS | UL60950-1, C-UL, EN60950-1, EN50178 Complies with DEN-AN and IEC60950-1 (At only AC input) | | | | | | | | | | |
| | CONDUCTED NOISE | Complies with FCC-B, CISPR22-B, EN55022-B, VCCI-B | | | | | | | | | | |
| | HARMONIC ATTENUATOR | Complies with IEC61000-3-2 *9 | | | | | | | | | | |
| OTHERS | CASE SIZE/WEIGHT | 85 x 40 x 222mm [3.35 x 1.57 x 8.74 inches] (W x H x D) /530g max (with chassis & cover : 870g max) | | | | | | | | | | |
| | COOLING METHOD | Convection | | | | | | | | | | |

*1 Specification is changed at option, refer to Instruction Manual 5.
 *2 Peak loading for 10sec. And Duty 35% max, refer to Instruction Manual 4. In detail.
 *3 Refer to Instruction Manual 2.2 in detail.
 *4 This is the value that measured on measuring board with capacitor of 22 μF within 150mm from output terminal. Measured by 20MHz oscilloscope or Ripple-Noise meter (Equivalent to KEISOKU-GIKEN: RM101).
 *5 Drift is the change in DC output for an eight hour period after a half-hour warm-up at 25°C, with the input voltage held constant at the rated input/output.

*6 ACIN 100V, Io=100%
 *7 Applicable when remote control (optional) is added.
 *8 Please contact us about safety approvals for the model with option.
 *9 Please contact us about class C.
 * Series/Parallel operation is not possible.
 * Derating is required when operated with chassis and cover.
 * A sound may occur from power supply at peak loading.

External view

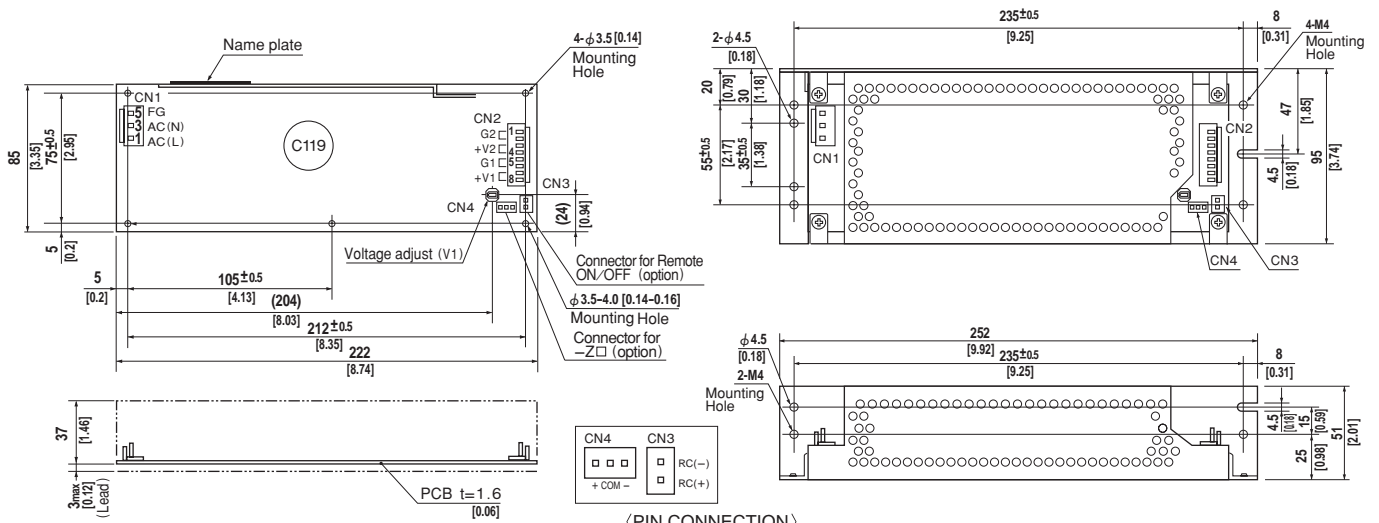

(PIN CONNECTION)

| I / O Connector | Mating Connector | Terminal |
|---------------------|------------------|----------------------|
| CN1 | B3P5-VH | VHR-5N |
| | | Chain: SVH-21T-P1.1 |
| | | Loose: BVH-21T-P1.1 |
| CN2 | B8P-VH | VHR-8N |
| | | Chain: SVH-21T-P1.1 |
| | | Loose: BVH-21T-P1.1 |
| CN3 (Option) | B2B-XH-A | XHP-2 |
| | | Chain: SXH-001T-P0.6 |
| | | Loose: BXH-001T-P0.6 |
| CN4 (Option) | B3B-XH-A | XHP-3 |
| | | Chain: SXH-001T-P0.6 |
| | | Loose: BXH-001T-P0.6 |

| CN1 | | CN2 | |
|---------|-------|---------|--------|
| Pin No. | Input | Pin No. | Output |
| 1 | AC(L) | 1, 2 | G 2 |
| 2 | | 3, 4 | V 2 |
| 3 | AC(N) | 5, 6 | G 1 |
| 4 | | 7, 8 | V 1 |
| 5 | FG | | |

| CN3 (Option) | |
|--------------|---------------|
| Pin No. | Remote ON/OFF |
| 1 | RC(+) |
| 2 | RC(-) |

| CN4 (Option) | |
|--------------|-----|
| Pin No. | -Z□ |
| 1 | + |
| 2 | COM |
| 3 | - |

※Weight: 530g max
(with chassis & cover : 870g max)
 ※Tolerance: ±1 [±0.04]
 ※Dimensions in mm, [] = inches
 ※PCB Material : CEM3
 ※Chassis and cover is optional.
 ※Mounting torque: 1.5N·m(16kgf·cm)max

(Mfr: J.S.T.)

※Keep drawing current per pin below 5A(7A at peak load)for CN2

Performance data

RISE TIME & FALL TIME (LEB150F-0524)

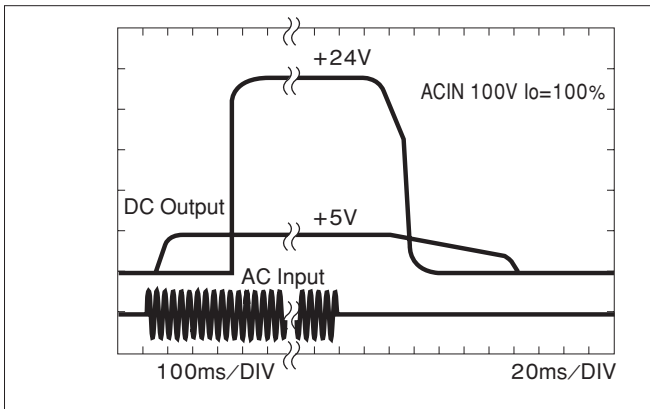

EFFICIENCY (LEB150F-0524)

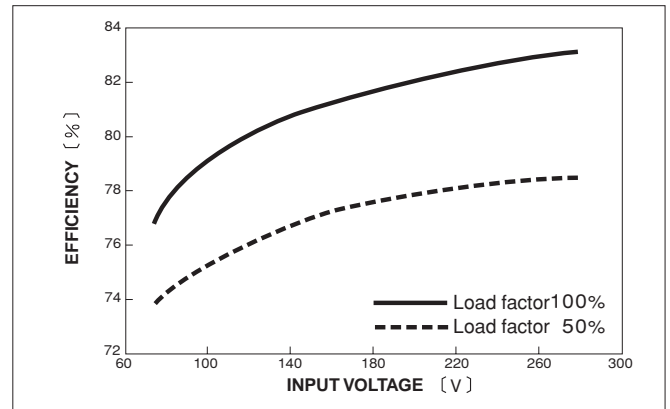

INPUT HARMONIC CURRENT (LEB150F-0524)

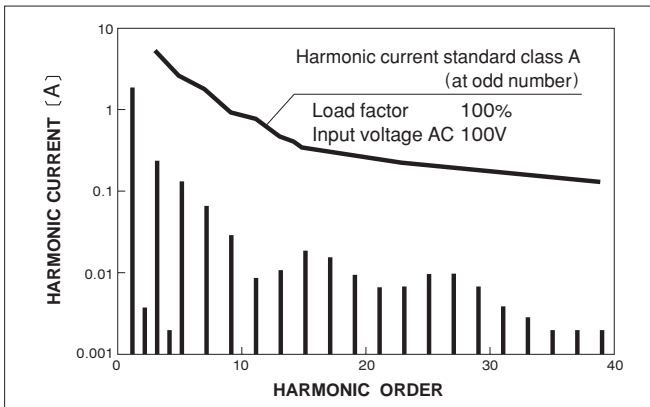

INPUT HARMONIC CURRENT (LEB150F-0524)

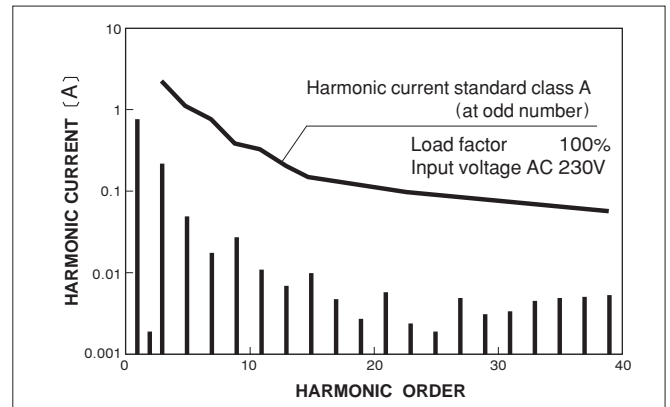

LEB225F

LEB 225 F -05 24 -□

① ② ③ ④ ⑤ ⑥

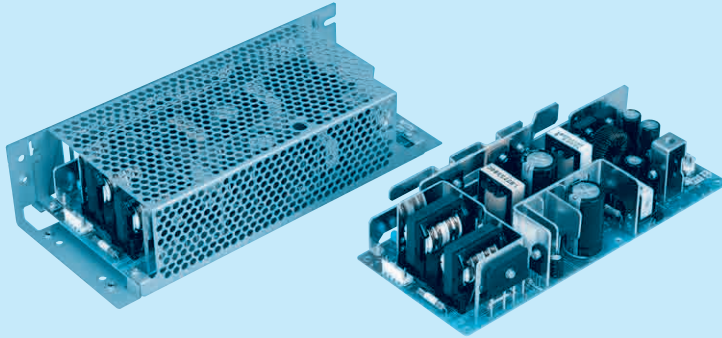

Recommended EMI/EMC Filter
NAC-06-472



High voltage pulse noise type : NAP series
Low leakage current type : NAM series
*The EMI/EMC Filter is recommended to connect with several devices.

- ① Series name
- ② Output wattage
- ③ Universal input
- ④ V1 Output voltage
- ⑤ V2 Output voltage
- ⑥ Optional *1 *8
- G :Low leakage current
- R :with Remote ON/OFF
- S :with Chassis
- SN :with Chassis & cover
- T :Vertical terminal block
- Y :with Potentiometer
- Z :with ZT

| MODEL | LEB225F-0512 | LEB225F-0324 | LEB225F-0524 | LEB225F-0530 | LEB225F-0536 | |
|-----------|--------------|-------------------|------------------|------------------|--------------------|-------------------|
| DC OUTPUT | V1 | +5V 5A | +3.3V 5A | +5V 5A | +5V 5A | +5V 5A |
| | V2 | +12V 10(Peak 20)A | +24V 9(Peak 14)A | +24V 9(Peak 14)A | +30V 7.2(Peak 11)A | +36V 6(Peak 9.3)A |

SPECIFICATIONS

| | MODEL | LEB225F-0512 | ★LEB225F-0324 | LEB225F-0524 | LEB225F-0530 | ★LEB225F-0536 | | | | | | |
|-------------------------------|---|--|--|------------------|-----------------|-----------------|-----------------|--------|-------------------|--------|------------------|--------|
| INPUT | VOLTAGE[V] | AC85 - 264 1 φ or DC 120 - 370 | | | | | | | | | | |
| | CURRENT[A] | ACIN 100V | 1.9typ (Io=100%) | 3.0typ (Io=100%) | | | | | | | | |
| | | ACIN 200V | 1.0typ (Io=100%) | 1.5typ (Io=100%) | | | | | | | | |
| | FREQUENCY[Hz] | 50/60 (47 - 63) or DC | | | | | | | | | | |
| | EFFICIENCY[%] | ACIN 100V | 77typ (Io=100%) | 81typ (Io=100%) | 81typ (Io=100%) | 81typ (Io=100%) | 81typ (Io=100%) | | | | | |
| | | ACIN 200V | 79typ (Io=100%) | 83typ (Io=100%) | 83typ (Io=100%) | 83typ (Io=100%) | 83typ (Io=100%) | | | | | |
| | POWER FACTOR | ACIN 100V | 0.98typ | 0.99typ | | | | | | | | |
| ACIN 200V | | 0.93typ | | | | | | | | | | |
| INRUSH CURRENT[A] | ACIN 100V | 15typ (Io=100%) (More than 3sec.to re-start) | | | | | | | | | | |
| | ACIN 200V | 30typ (Io=100%) (More than 3sec.to re-start) | | | | | | | | | | |
| LEAKAGE CURRENT[mA] | 0.75max (60Hz, According to IEC60950 and DEN-AN) | | | | | | | | | | | |
| OUTPUT | VOLTAGE[V] | +5 | +12 | +3.3 | +24 | +5 | +30 | +5 | +36 | | | |
| | CURRENT[A] | *2 0 - 5 | 0 - 10 (Peak 20) | 0 - 5 | 0 - 9 (Peak 14) | 0 - 5 | 0 - 9 (Peak 14) | 0 - 5 | 0 - 7.2 (Peak 11) | 0 - 5 | 0 - 6 (Peak 9.3) | |
| | TOTAL OUTPUT WATTAGE[W] | *3 145 (Peak 265) | | | | | | | | | | |
| | LINE REGULATION[mV] | 20max | 48max | 20max | 96max | 20max | 96max | 20max | 120max | 20max | 144max | |
| | | 40max | 100max | 40max | 150max | 40max | 150max | 40max | 180max | 40max | 180max | |
| | LOAD REGULATION[mV] | 80max | 120max | 80max | 120max | 80max | 120max | 80max | 200max | 80max | 200max | |
| | | 140max | 160max | 140max | 160max | 140max | 160max | 140max | 240max | 140max | 240max | |
| | RIPPLE[mVp-p] | 0 to +40°C *4 | 80max | 120max | 80max | 120max | 80max | 120max | 80max | 200max | 80max | 200max |
| | | -10 - 0°C *4 | 140max | 160max | 140max | 160max | 140max | 160max | 140max | 240max | 140max | 240max |
| | RIPPLE NOISE[mVp-p] | 0 to +40°C *4 | 120max | 150max | 120max | 150max | 120max | 150max | 120max | 300max | 120max | 300max |
| | | -10 - 0°C *4 | 160max | 180max | 160max | 180max | 160max | 180max | 160max | 360max | 160max | 360max |
| | TEMPERATURE REGULATION[mV] | 0 to +40°C | 50max | 120max | 50max | 240max | 50max | 240max | 50max | 300max | 50max | 300max |
| | | -10 to +40°C | 60max | 150max | 60max | 290max | 60max | 290max | 60max | 350max | 60max | 350max |
| | DRIFT[mV] | *5 20max | 48max | 20max | 96max | 20max | 96max | 20max | 120max | 20max | 144max | |
| | START-UP TIME[ms] | *6 250max | 500max | 250max | 500max | 250max | 500max | 250max | 500max | 250max | 500max | |
| | HOLD-UP TIME[ms] | *6 40typ | 20typ | 40typ | 20typ | 40typ | 20typ | 40typ | 20typ | 40typ | 20typ | |
| | OUTPUT VOLTAGE ADJUSTMENT RANGE[V] | 4.5 - 5.5 Fixed 2.85 - 3.60 Fixed 4.5 - 5.5 Fixed 4.5 - 5.5 Fixed | | | | | | | | | | |
| OUTPUT VOLTAGE SETTING[V] | — 11.5 - 12.5 — 23.0 - 25.0 — 23.0 - 25.0 — 28.7 - 31.5 — 34.5 - 37.5 | | | | | | | | | | | |
| PROTECTION CIRCUIT AND OTHERS | OVERCURRENT PROTECTION | V1 | Works over 105% of rating current and recovers automatically | | | | | | | | | |
| | | V2 | Works over 101% of peak current and recovers automatically | | | | | | | | | |
| | OVERVOLTAGE PROTECTION | V1 | Works over 115% of rating, by zener diode clamping | | | | | | | | | |
| | | V2 | Works at 115 - 140% of rating | | | | | | | | | |
| REMOTE ON/OFF | Option (Refer to Instruction Manual) | | | | | | | | | | | |
| ISOLATION | INPUT-OUTPUT · RC | *7 AC3.000V 1minute, Cutoff current = 10mA, DC500V 50MΩ min (At Room Temperature) | | | | | | | | | | |
| | INPUT-FG | AC2.000V 1minute, Cutoff current = 10mA, DC500V 50MΩ min (At Room Temperature) | | | | | | | | | | |
| | OUTPUT · RC-FG | AC500V 1minute, Cutoff current = 100mA, DC500V 50MΩ min (At Room Temperature) | | | | | | | | | | |
| | OUTPUT-OUTPUT(V1 · RC-V2) | *7 AC100V 1minute, Cutoff current = 100mA, DC100V 10MΩ min (At Room Temperature) | | | | | | | | | | |
| ENVIRONMENT | OPERATING TEMP., HUMID. AND ALTITUDE | -10 to +70°C, 20 - 90%RH (Non condensing) (Refer to DERATING CURVE), 3,000m (10,000feet) max | | | | | | | | | | |
| | STORAGE TEMP., HUMID. AND ALTITUDE | -20 to +75°C, 20 - 90%RH (Non condensing), 9,000m (30,000feet) max | | | | | | | | | | |
| | VIBRATION | 10 - 55Hz, 19.6m/s ² (2G), 3minutes period, 60minutes each along X, Y and Z axis | | | | | | | | | | |
| SAFETY AND NOISE REGULATIONS | IMPACT | 196.1m/s ² (20G), 11ms, once each X, Y and Z axis | | | | | | | | | | |
| | AGENCY APPROVALS | UL60950-1, C-UL, EN60950-1, EN50178 Complies with DEN-AN and IEC60950-1 (At only AC input) | | | | | | | | | | |
| | CONDUCTED NOISE | Complies with FCC-B, CISPR22-B, EN55022-B, VCCI-B | | | | | | | | | | |
| OTHERS | HARMONIC ATTENUATOR | Complies with IEC61000-3-2 *9 | | | | | | | | | | |
| | CASE SIZE/WEIGHT | 95 x 45 x 222mm [3.74 x 1.77 x 8.74 inches] /700g max (with chassis & cover : 1,080g max) | | | | | | | | | | |
| | COOLING METHOD | Convection | | | | | | | | | | |

*1 Specification is changed at option, refer to Instruction Manual 5.
 *2 Peak loading for 10sec. And Duty 35% max, refer to Instruction Manual 4. In detail.
 *3 Refer to Instruction Manual 2.2 in detail.
 *4 This is the value that measured on measuring board with capacitor of 22 μF within 150mm from output terminal. Measured by 20MHz oscilloscope or Ripple-Noise meter (Equivalent to KEISOKU-GIKEN: RM101).
 *5 Drift is the change in DC output for an eight hour period after a half-hour warm-up at 25°C, with the input voltage held constant at the rated input/output.

*6 ACIN 100V, Io=100%
 *7 Applicable when remote control (optional) is added.
 *8 Please contact us about safety approvals for the model with option.
 *9 Please contact us about class C.
 * Series/Parallel operation is not possible.
 * Derating is required when operated with chassis and cover.
 * A sound may occur from power supply at peak loading.
 *marked models are pending for safety approvals. Consult with us for delivery.

External view

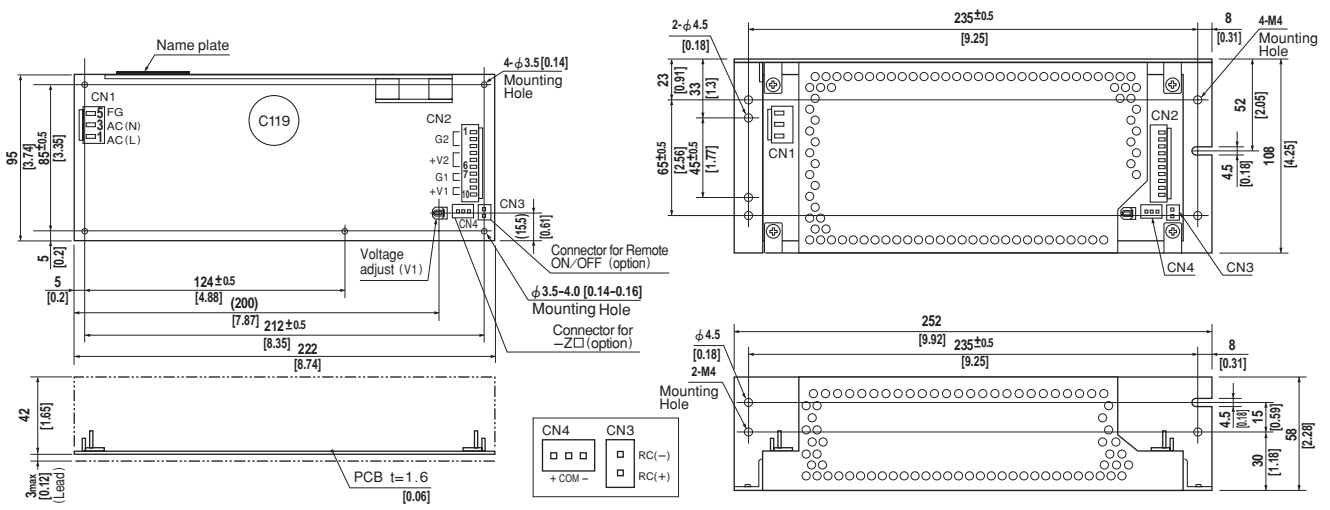

| I / O Connector | Mating Connector | Terminal |
|---------------------|------------------|----------------------|
| CN1 | B3P5-VH | VHR-5N |
| | | Chain: SVH-21T-P1.1 |
| | | Loose: BVH-21T-P1.1 |
| CN2 | B10P-VH | VHR-10N |
| | | Chain: SVH-21T-P1.1 |
| | | Loose: BVH-21T-P1.1 |
| CN3 (Option) | B2B-XH-A | XHP-2 |
| | | Chain: SXH-001T-P0.6 |
| | | Loose: BXH-001T-P0.6 |
| CN4 (Option) | B3B-XH-A | XHP-3 |
| | | Chain: SXH-001T-P0.6 |
| | | Loose: BXH-001T-P0.6 |

(PIN CONNECTION)

| CN1 | | CN2 | | CN3 (Option) | | CN4 (Option) | |
|---------|-------|---------|--------|--------------|---------------|--------------|-----|
| Pin No. | Input | Pin No. | Output | Pin No. | Remote ON/OFF | Pin No. | -Z□ |
| 1 | AC(L) | 1, 2, 3 | G 2 | 1 | RC(+) | 1 | + |
| 2 | | 4, 5, 6 | V 2 | 2 | RC(-) | 2 | COM |
| 3 | AC(N) | 7, 8 | G 1 | | | 3 | - |
| 4 | | 9, 10 | V 1 | | | | |
| 5 | FG | | | | | | |

(Mfr: J.S.T.) ※Keep drawing current per pin below 5A (7A at peak load) for CN2

- ※Weight: 700g max (with chassis & cover : 1,080g max)
- ※Tolerance: ±1 [±0.04]
- ※Dimensions in mm, [] = inches
- ※PCB Material : CEM3
- ※Chassis and cover is optional.
- ※Mounting torque: 1.5N · m(16kgf · cm)max

Performance data

RISE TIME & FALL TIME (LEB225F-0524)

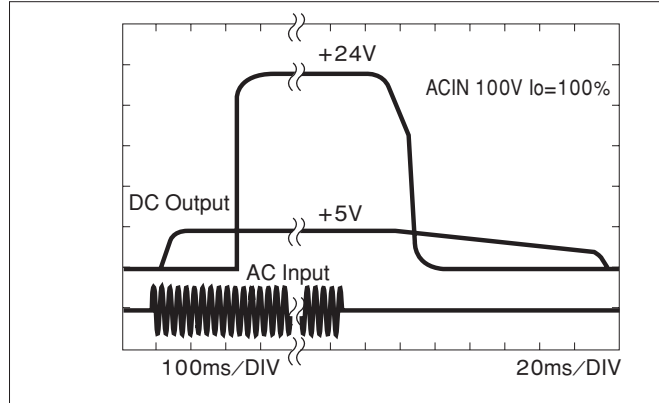

EFFICIENCY (LEB225F-0524)

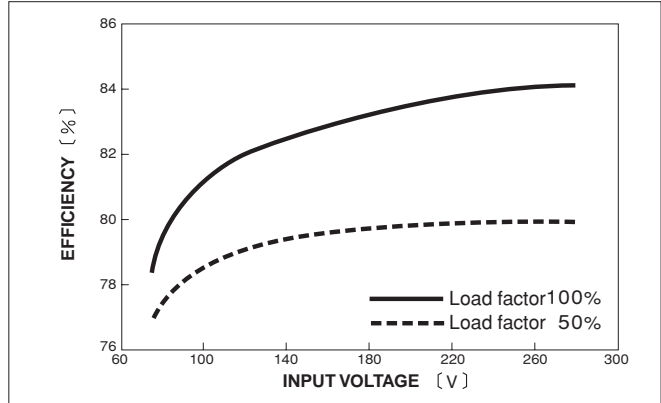

INPUT HARMONIC CURRENT (LEB225F-0524)

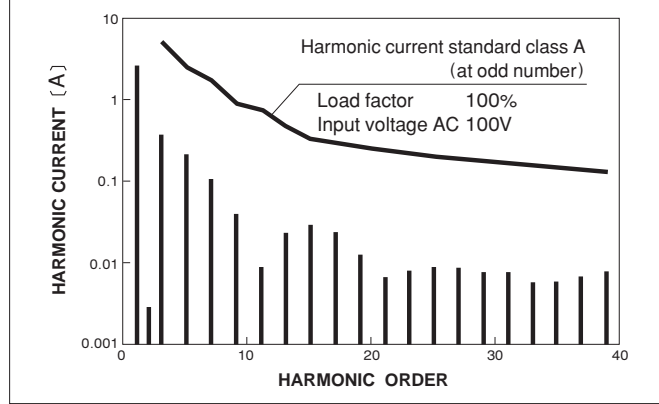

INPUT HARMONIC CURRENT (LEB225F-0524)

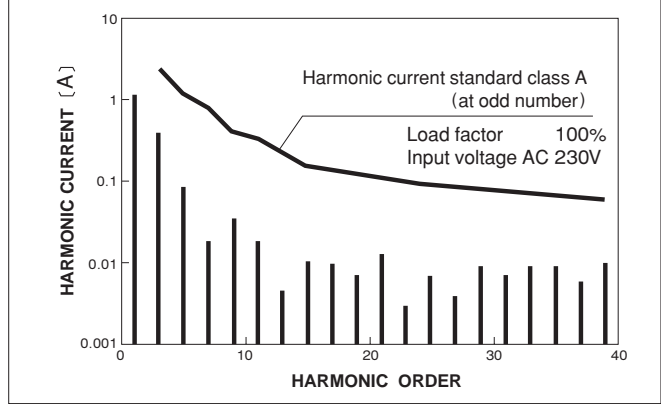

Mouser Electronics

Authorized Distributor

Click to View Pricing, Inventory, Delivery & Lifecycle Information:

Cosel:

[LEB100F-0512-SNT](#) [LEB100F-0524-Z32](#) [LEB100F-0524-Z34](#) [LEB150F-0524-RY](#) [LEB225F-0524-SN](#) [LEB225F-0524-SNY](#) [LEB225F-0524-RY](#) [LEB225F-0536-SN](#) [LEB225F-0324-SN](#) [LEB225F-0324-SNT](#) [LEB225F-0324-T](#) [LEB225F-0512-TY](#) [LEB225F-0524](#) [LEB150F-0536](#) [LEB225F-0324](#) [LEB225F-0524-S](#) [LEB225F-0524-SNR](#) [LEB225F-0524-T](#) [LEB225F-0530](#) [LEB150F-0512-S](#) [LEB150F-0524-SN](#) [LEB150F-0524-SNY](#) [LEB150F-0524-SNZ31](#) [LEB150F-0524-SNZ35](#) [LEB150F-0524-U](#) [LEB100F-0524-RY](#) [LEB100F-0524-SNY](#) [LEB100F-0524-SZ32](#) [LEB100F-0524-SZ35](#) [LEB100F-0524-T](#) [LEB100F-0536-SNT](#) [LEB100F-0512-C](#) [LEB100F-0512-SNRT](#) [LEB100F-0512-SNZ25](#) [LEB100F-0512-SZ22](#) [LEB100F-0512-Z21](#) [LEB100F-0524-GR](#) [LEB100F-0524-SNZ32](#) [LEB100F-0524-SR](#) [LEB100F-0536-RY](#) [LEB100F-0536-SN](#) [LEB100F-0536-Y](#) [LEB100F-0512](#) [LEB100F-0512-SZ23](#) [LEB100F-0512-SZ25](#) [LEB100F-0512-Y](#) [LEB100F-0524-G](#) [LEB100F-0524-RT](#) [LEB100F-0524-SN](#) [LEB225F-0536-R](#) [LEB100F-0324-T](#) [LEB100F-0324-Y](#) [LEB100F-0512-GR](#) [LEB100F-0512-SNY](#) [LEB100F-0512-SZ21](#) [LEB225F-0524-SNC](#) [LEB225F-0524-SNGT](#) [LEB225F-0524-SNT](#) [LEB225F-0524-SNZ35](#) [LEB225F-0530-S](#) [LEB225F-0536](#) [LEB225F-0512-SNZ25](#) [LEB225F-0512-Y](#) [LEB225F-0524-CR](#) [LEB225F-0524-CY](#) [LEB225F-0524-G](#) [LEB225F-0524-R](#) [LEB150F-0524-Y](#) [LEB150F-0524-Z34](#) [LEB150F-0530](#) [LEB150F-0536-SN](#) [LEB225F-0512-SN](#) [LEB225F-0512-SNR](#) [LEB150F-0512-SNT](#) [LEB150F-0512-Z25](#) [LEB150F-0524-S](#) [LEB150F-0524-SNRT](#) [LEB150F-0524-SNT](#) [LEB150F-0524-TY](#) [LEB225F-0524-SZ35](#) [LEB225F-0524-TY](#) [LEB225F-0524-U](#) [LEB225F-0524-Y](#) [LEB150F-0512-G](#) [LEB150F-0512-R](#) [LEB100F-0530-Y](#) [LEB100F-0536-C](#) [LEB100F-0536-R](#) [LEB225F-0524-CRY](#) [LEB225F-0524-GY](#) [LEB225F-0524-SNG](#) [LEB100F-0524-ST](#) [LEB100F-0524-SZ31](#) [LEB100F-0524-SZ34](#) [LEB100F-0524-U](#) [LEB100F-0524-Y](#) [LEB100F-0524-Z35](#) [LEB100F-0524-CT](#) [LEB100F-0524-GT](#) [LEB100F-0524-R](#)



Компания «ЭлектроПласт» предлагает заключение долгосрочных отношений при поставках импортных электронных компонентов на взаимовыгодных условиях!

Наши преимущества:

- Оперативные поставки широкого спектра электронных компонентов отечественного и импортного производства напрямую от производителей и с крупнейших мировых складов;
- Поставка более 17-ти миллионов наименований электронных компонентов;
- Поставка сложных, дефицитных, либо снятых с производства позиций;
- Оперативные сроки поставки под заказ (от 5 рабочих дней);
- Экспресс доставка в любую точку России;
- Техническая поддержка проекта, помощь в подборе аналогов, поставка прототипов;
- Система менеджмента качества сертифицирована по Международному стандарту ISO 9001;
- Лицензия ФСБ на осуществление работ с использованием сведений, составляющих государственную тайну;
- Поставка специализированных компонентов (Xilinx, Altera, Analog Devices, Intersil, Interpoint, Microsemi, Aeroflex, Peregrine, Syfer, Eurofarad, Texas Instrument, Miteq, Cobham, E2V, MA-COM, Hittite, Mini-Circuits, General Dynamics и др.);

Помимо этого, одним из направлений компании «ЭлектроПласт» является направление «Источники питания». Мы предлагаем Вам помощь Конструкторского отдела:

- Подбор оптимального решения, техническое обоснование при выборе компонента;
- Подбор аналогов;
- Консультации по применению компонента;
- Поставка образцов и прототипов;
- Техническая поддержка проекта;
- Защита от снятия компонента с производства.



Как с нами связаться

Телефон: 8 (812) 309 58 32 (многоканальный)

Факс: 8 (812) 320-02-42

Электронная почта: org@eplast1.ru

Адрес: 198099, г. Санкт-Петербург, ул. Калинина, дом 2, корпус 4, литера А.