

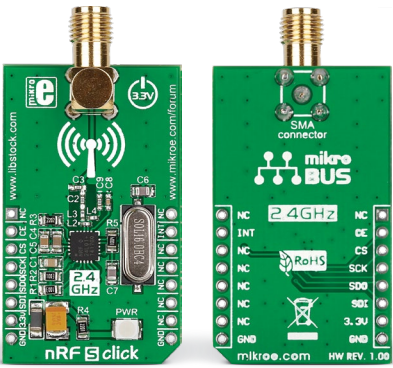

nRF S click™



1. Introduction

nRF S click™ is a compact and easy solution for adding a 2.4 GHz transceiver to your design. It features **nRF24L01P** 2.4 GHz transceiver module with an embedded baseband protocol engine as well as an SMA antenna connector (antenna sold separately). nRF S click™ communicates with the target board microcontroller via **mikroBUS™** SPI (SDI, SDO, SCK, CS#), CE and INT lines. The board is designed to use 3.3V power supply only.

2. Soldering the headers

Before using your click™ board, make sure to solder 1x8 male headers to both left and right side of the board. Two 1x8 male headers are included with the board in the package.

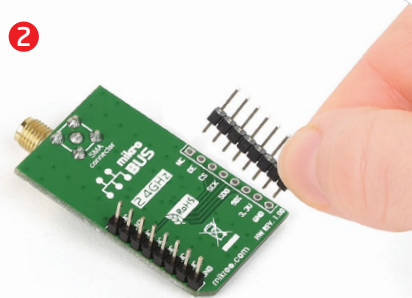

Turn the board upside down so that the bottom side is facing you upwards. Place shorter pins of the header into the appropriate soldering pads.

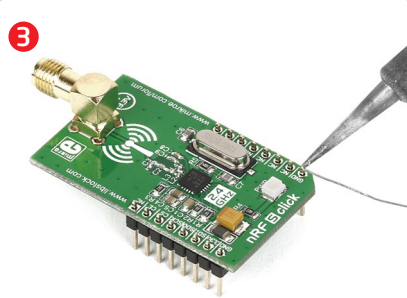

Turn the board upward again. Make sure to align the headers so that they are perpendicular to the board, then solder the pins carefully.

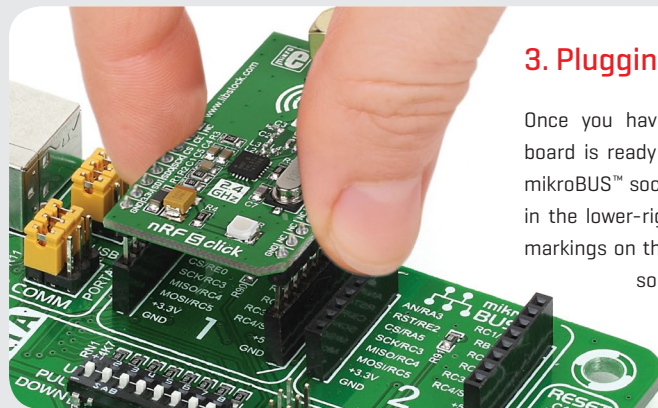

3. Plugging the board in

Once you have soldered the headers your board is ready to be placed into the desired mikroBUS™ socket. Make sure to align the cut in the lower-right part of the board with the markings on the silkscreen at the mikroBUS™ socket. If all the pins are aligned correctly, push the board all the way into the socket.

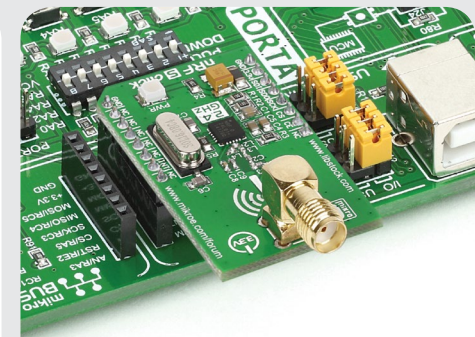

4. Essential features

nRF S click™ with its nRF24L01P IC is designed for operation in the world wide ISM frequency band at **2.400 - 2.4835 GHz**. The board supports an air data rate of 250 Kbps, 1 Mbps and 2 Mbps and it is suitable for ultra low power designs. All these features make this board ideal for wireless PC peripherals, remotes, VoIP headsets, game controllers, sensors, home and commercial automation, active RFID, toys and many more.

click™
BOARD
www.mikroe.com

nRF S click Manual v100
 010000076071

5. Schematic

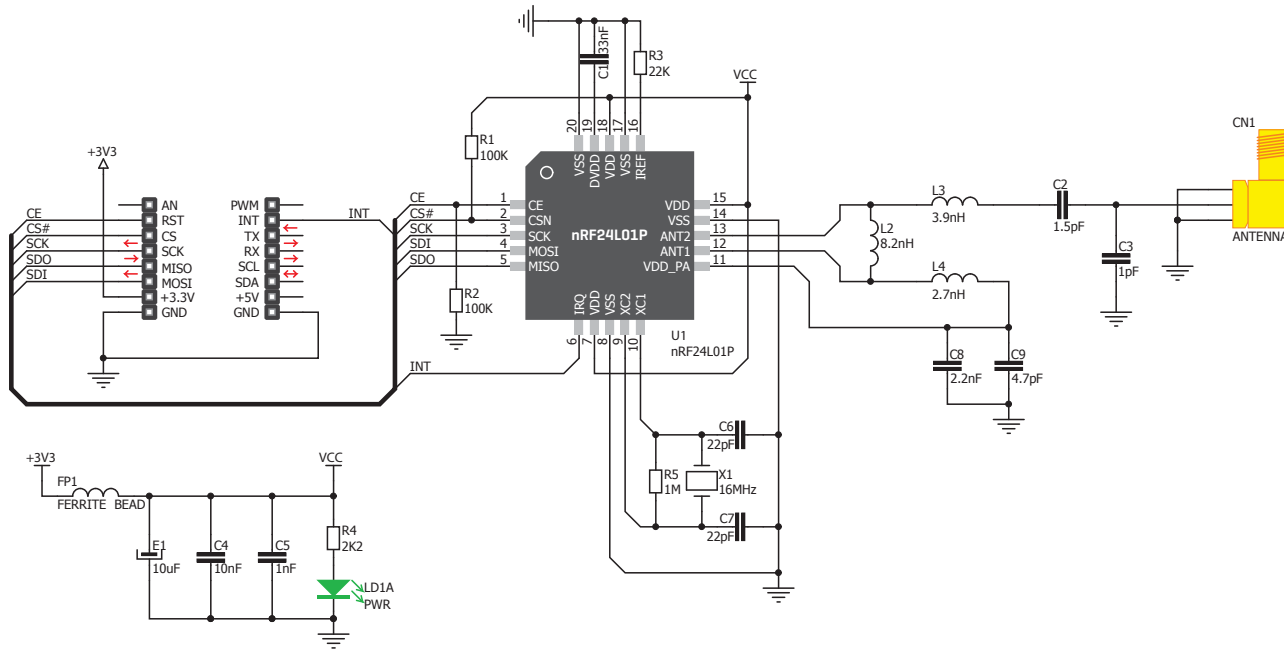

6. Dimensions

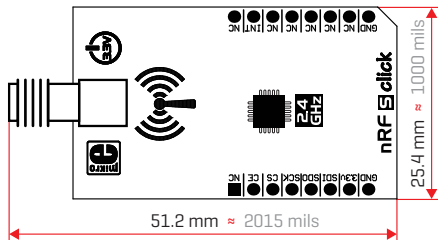

	mm	mils
LENGTH	51.2	2015
WIDTH	25.4	1000
HEIGHT	8.2	323

7. Alternative antennas options

Two other click™ boards with the nRF24L01P chip, but with different antennas are available. NRF T click™ with a PCB trace antenna, and nRF C click™ with an SMD chip antenna.

See them at:

www.mikroe.com/click/nrf-t

www.mikroe.com/click/nrf-c

8. Code examples

Once you have done all the necessary preparations, it's time to get your click™ board up and running. We have provided examples for mikroC™, mikroBasic™ and mikroPascal™ compilers on our **Libstock** website. Just download them and you are ready to start.



9. Support

MikroElektronika offers **free tech support** [www.mikroe.com/support] until the end of the product's lifetime, so if something goes wrong, we're ready and willing to help!

MikroElektronika assumes no responsibility or liability for any errors or inaccuracies that may appear in the present document. Specification and information contained in the present schematic are subject to change at any time without notice.

Copyright © 2015 MikroElektronika.

All rights reserved.





Компания «ЭлектроПласт» предлагает заключение долгосрочных отношений при поставках импортных электронных компонентов на взаимовыгодных условиях!

Наши преимущества:

- Оперативные поставки широкого спектра электронных компонентов отечественного и импортного производства напрямую от производителей и с крупнейших мировых складов;
- Поставка более 17-ти миллионов наименований электронных компонентов;
- Поставка сложных, дефицитных, либо снятых с производства позиций;
- Оперативные сроки поставки под заказ (от 5 рабочих дней);
- Экспресс доставка в любую точку России;
- Техническая поддержка проекта, помощь в подборе аналогов, поставка прототипов;
- Система менеджмента качества сертифицирована по Международному стандарту ISO 9001;
- Лицензия ФСБ на осуществление работ с использованием сведений, составляющих государственную тайну;
- Поставка специализированных компонентов (Xilinx, Altera, Analog Devices, Intersil, Interpoint, Microsemi, Aeroflex, Peregrine, Syfer, Eurofarad, Texas Instrument, Miteq, Cobham, E2V, MA-COM, Hittite, Mini-Circuits, General Dynamics и др.);

Помимо этого, одним из направлений компании «ЭлектроПласт» является направление «Источники питания». Мы предлагаем Вам помощь Конструкторского отдела:

- Подбор оптимального решения, техническое обоснование при выборе компонента;
- Подбор аналогов;
- Консультации по применению компонента;
- Поставка образцов и прототипов;
- Техническая поддержка проекта;
- Защита от снятия компонента с производства.



Как с нами связаться

Телефон: 8 (812) 309 58 32 (многоканальный)

Факс: 8 (812) 320-02-42

Электронная почта: org@eplast1.ru

Адрес: 198099, г. Санкт-Петербург, ул. Калинина, дом 2, корпус 4, литера А.