

N-channel 950 V, 0.275 Ω typ., 18 A, MDmesh™ DK5 Power MOSFETs in TO-247 and TO-247 long leads packages

Datasheet - production data

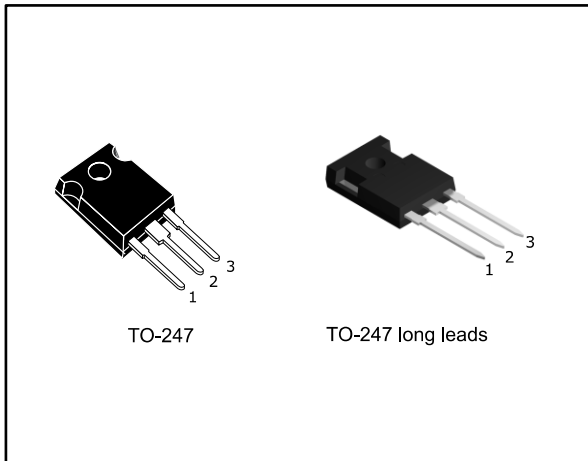
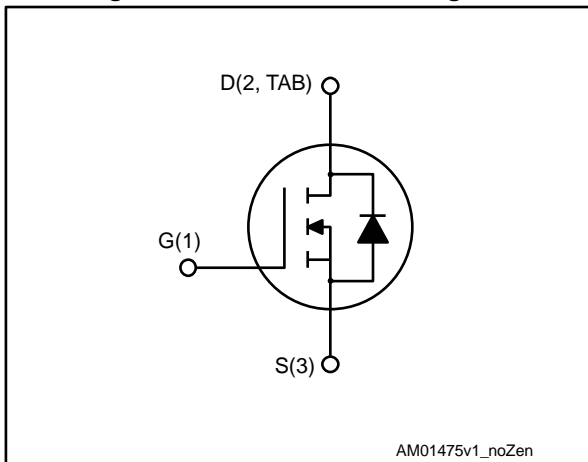

Figure 1: Internal schematic diagram



Features

Order code	V _{DS}	R _{DS(on)} max.	I _D
STW20N95DK5	950 V	0.330 Ω	18 A
STWA20N95DK5			

- Fast-recovery body diode
- Best R_{DS(on)} x area
- Low gate charge, input capacitance and resistance
- 100% avalanche tested
- Extremely high dv/dt ruggedness

Applications

- Switching applications

Description

These very high voltage N-channel Power MOSFETs are part of the MDmesh™ DK5 fast recovery diode series. The MDmesh™ DK5 combines very low recovery charge (Q_{rr}) and recovery time (t_{rr}) with an excellent improvement in R_{DS(on)} * area and one of the most effective switching behaviors, ideal for half bridge and full bridge converters.

Table 1: Device summary

Order code	Marking	Package	Packing
STW20N95DK5	20N95DK5	TO-247	Tube
STWA20N95DK5		TO-247 long leads	

Contents

1	Electrical ratings	3
2	Electrical characteristics	4
	2.1 Electrical characteristics (curves).....	6
3	Test circuits	9
4	Package information	10
	4.1 TO-247 package information.....	10
	4.2 TO-247 long leads package information	12
5	Revision history	14

1 Electrical ratings

Table 2: Absolute maximum ratings

Symbol	Parameter	Value	Unit
V_{GS}	Gate-source voltage	± 30	V
I_D	Drain current (continuous) at $T_C = 25\text{ }^\circ\text{C}$	18	V
I_D	Drain current (continuous) at $T_C = 100\text{ }^\circ\text{C}$	11	A
$I_{DM}^{(1)}$	Drain current (pulsed)	72	A
P_{TOT}	Total dissipation at $T_C = 25\text{ }^\circ\text{C}$	250	W
$dv/dt^{(2)}$	Peak diode recovery voltage slope	50	V/ns
$dv/dt^{(3)}$	MOSFET dv/dt ruggedness	50	V/ns
T_{stg}	Storage temperature range	-55 to 150	$^\circ\text{C}$
T_j	Operating junction temperature range		

Notes:

(1) Pulse width limited by safe operating area

(2) $I_{SD} \leq 8.5\text{ A}$, $di/dt \leq 400\text{ A}/\mu\text{s}$, $V_{DS\text{ peak}} \leq V_{(BR)DSS}$, $V_{DD} = 475\text{ V}$

(3) $V_{DS} \leq 760\text{ V}$

Table 3: Avalanche characteristics

Symbol	Parameter	Value	Unit
$R_{thj-case}$	Thermal resistance junction-case	0.5	$^\circ\text{C}/\text{W}$
$R_{thj-amb}$	Thermal resistance junction-ambient	50	$^\circ\text{C}/\text{W}$

Table 4: Thermal data

Symbol	Parameter	Value	Unit
I_{AR}	Maximum current during repetitive or single pulse avalanche	6	A
E_{AS}	Single pulse avalanche energy (starting $T_J = 25\text{ }^\circ\text{C}$, $I_D = I_{AR}$, $V_{DD} = 50\text{ V}$)	520	mJ

2 Electrical characteristics

(T_{CASE} = 25 °C unless otherwise specified)

Table 5: On/off states

Symbol	Parameter	Test conditions	Min.	Typ.	Max.	Unit
V _{(BR)DSS}	Drain-source breakdown voltage	I _D = 1 mA, V _{GS} = 0 V	950			V
I _{DSS}	Zero gate voltage drain current	V _{GS} = 0 V, V _{DS} = 950 V			10	μA
		V _{GS} = 0 V, V _{DS} = 950 V, T _C = 125 °C ⁽¹⁾			100	μA
I _{GSS}	Gate source leakage current	V _{DS} = 0 V, V _{GS} = ± 20 V			±2	μA
V _{GS(th)}	Gate threshold voltage	V _{DD} = V _{GS} , I _D = 100 μA	3	4	5	V
R _{DS(on)}	Static drain-source on-resistance	V _{GS} = 10 V, I _D = 9 A		0.275	0.330	Ω

Notes:

⁽¹⁾Defined by design, not subject to production test

Table 6: Dynamic

Symbol	Parameter	Test conditions	Min.	Typ.	Max.	Unit
C _{iss}	Input capacitance	V _{DS} = 100 V, f = 1 MHz, V _{GS} = 0 V	-	1600	-	pF
C _{oss}	Output capacitance		-	76	-	pF
C _{rss}	Reverse transfer capacitance		-	5	-	pF
C _{o(tr)} ⁽¹⁾	Time-related equivalent capacitance	V _{GS} = 0 V, V _{DS} = 0 to 760 V	-	169	-	pF
C _{o(er)} ⁽²⁾	Energy-related equivalent capacitance		-	60	-	pF
R _g	Intrinsic gate resistance	f = 1 MHz, I _D = 0 A	-	4	-	Ω
Q _g	Total gate charge	V _{DD} = 760 V, I _D = 18 A, V _{GS} = 0 to 10 V (see Figure 16: "Test circuit for gate charge behavior")	-	50.7	-	nC
Q _{gs}	Gate source charge		-	7.8	-	nC
Q _{gd}	Gate drain charge		-	34.2	-	nC

Notes:

⁽¹⁾C_{o(tr)} is defined as the constant equivalent capacitance giving the same charging time as C_{oss} when V_{DS} increases from 0 to 80% V_{DSS}.

⁽²⁾C_{o(er)} is defined as the constant equivalent capacitance giving the same stored energy as C_{oss} when V_{DS} increases from 0 to 80% V_{DSS}.

Table 7: Switching times

Symbol	Parameter	Test conditions	Min.	Typ.	Max.	Unit
$t_{d(on)}$	Turn-on delay time	$V_{DS} = 475\text{ V}$, $I_D = 9\text{ A}$, $R_G = 4.7\ \Omega$, $V_{GS} = 10\text{ V}$ (see Figure 15: "Test circuit for resistive load switching times" and Figure 20: "Switching time waveform")	-	23	-	ns
t_r	Rise time		-	23	-	ns
$t_{d(off)}$	Turn-off delay time		-	74	-	ns
t_f	Fall time		-	25.4	-	ns

Table 8: Source-drain diode

Symbol	Parameter	Test conditions	Min.	Typ.	Max.	Unit
I_{SD}	Source-drain current		-		18	A
$I_{SDM}^{(1)}$	Source-drain current (pulsed)		-		72	A
$V_{SD}^{(2)}$	Forward on voltage	$I_{SD} = 18\text{ A}$, $V_{GS} = 0\text{ V}$	-		1.5	V
t_{rr}	Reverse recovery time	$I_{SD} = 9\text{ A}$, $di/dt = 100\text{ A}/\mu\text{s}$, $V_{DD} = 60\text{ V}$ (see Figure 17: "Test circuit for inductive load switching and diode recovery times")	-	150		ns
Q_{rr}	Reverse recovery charge		-	1		μC
I_{RRM}	Reverse recovery current		-	13.5		A
t_{rr}	Reverse recovery time	$I_{SD} = 9\text{ A}$, $di/dt = 100\text{ A}/\mu\text{s}$, $V_{DD} = 60\text{ V}$, $T_j = 150\text{ }^\circ\text{C}$ (see Figure 17: "Test circuit for inductive load switching and diode recovery times")	-	264		ns
Q_{rr}	Reverse recovery charge		-	2.9		μC
I_{RRM}	Reverse recovery current		-	22		A

Notes:

(1)Pulse width limited by safe operating area

(2)Pulsed: pulse duration = 300 μs , duty cycle 1.5%.

2.1 Electrical characteristics (curves)

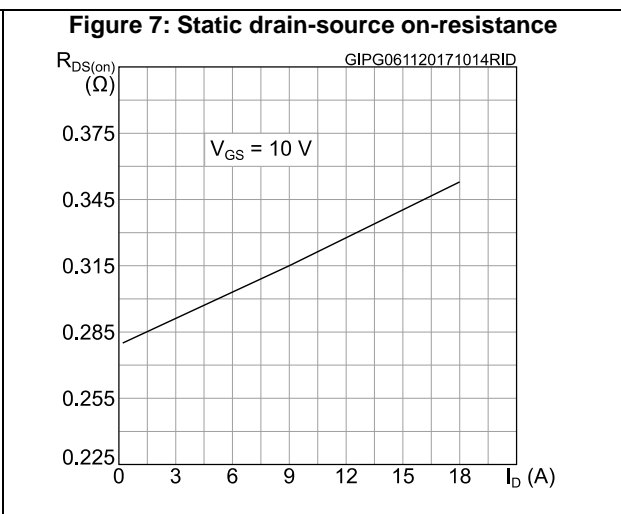
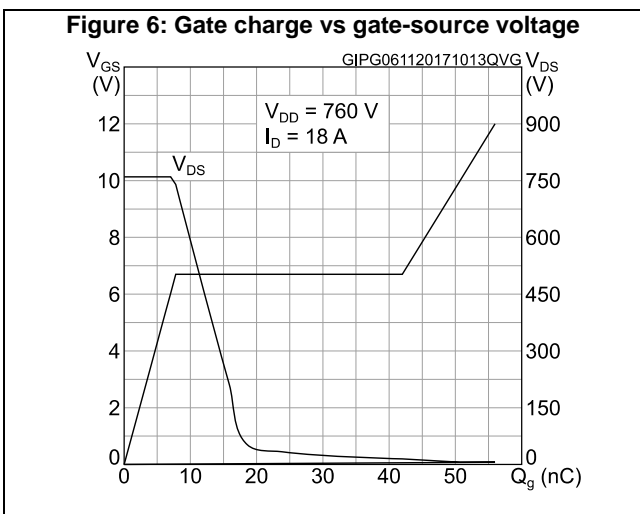
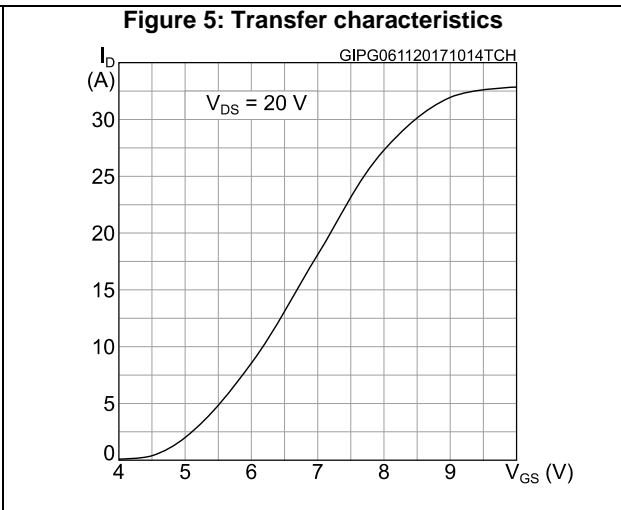
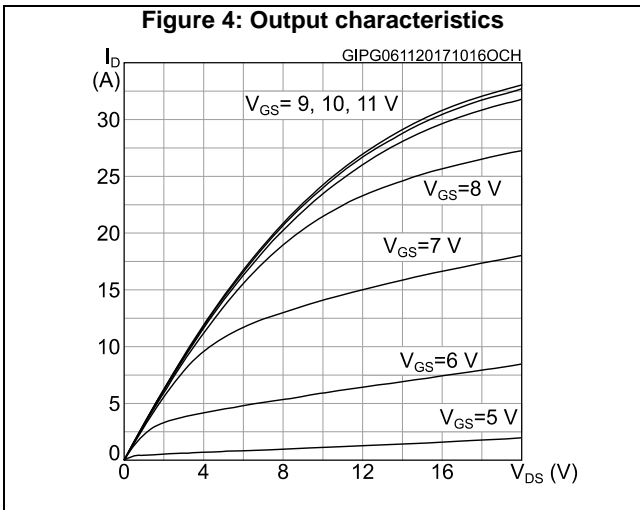
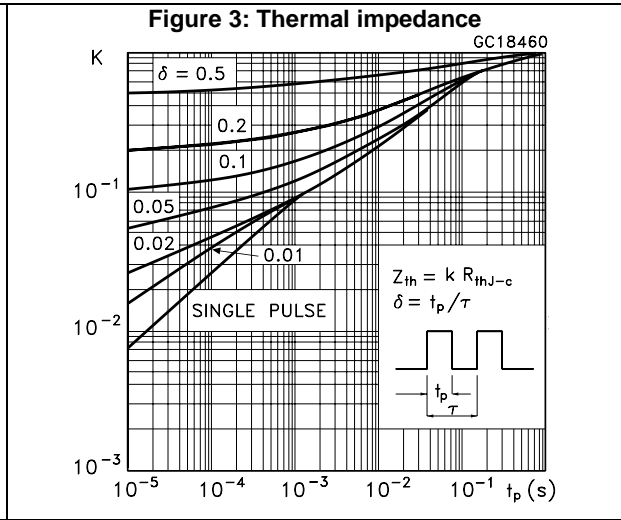
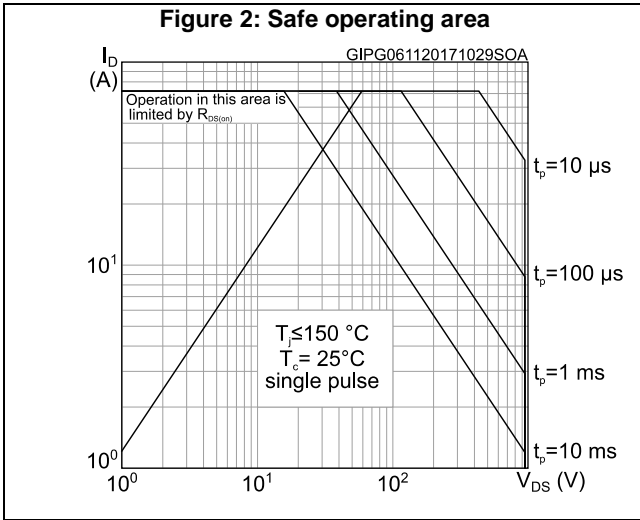

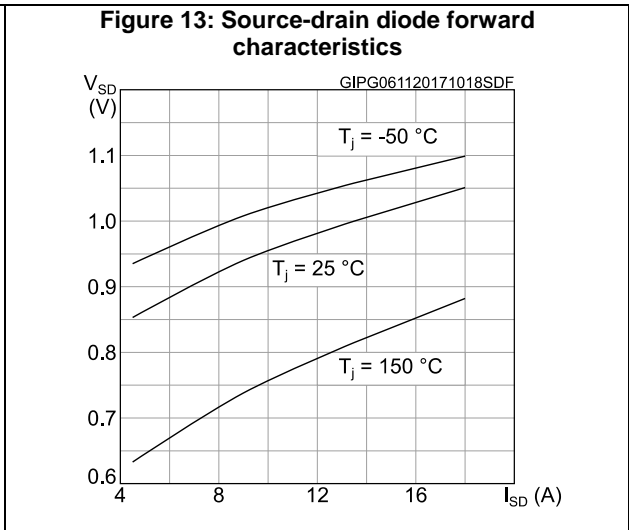
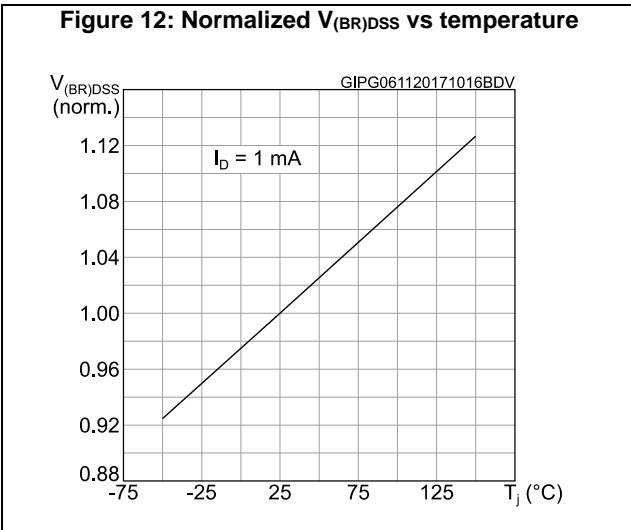
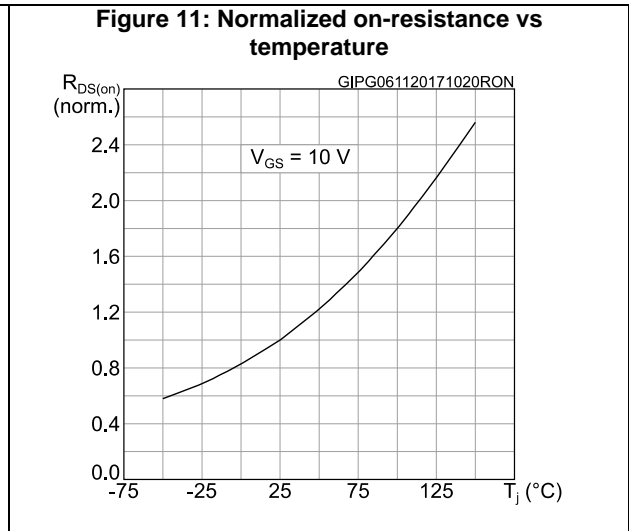
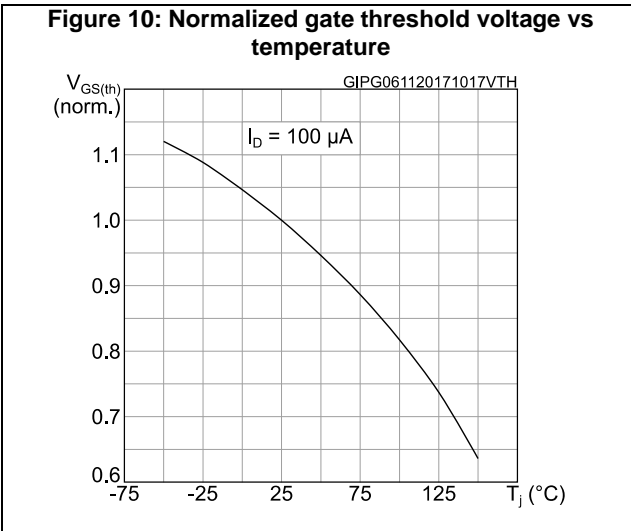
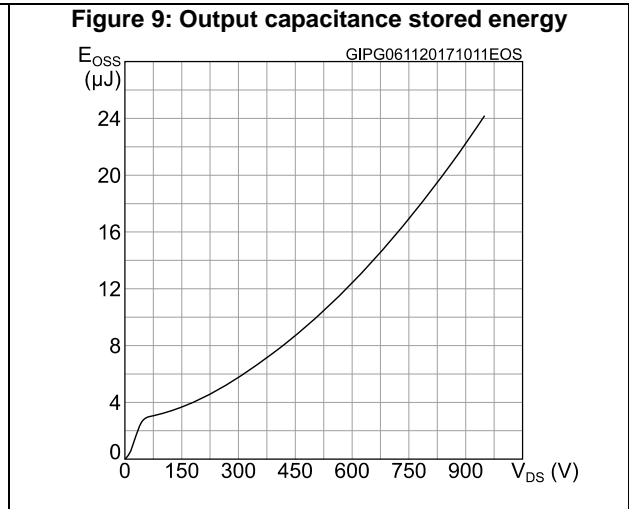
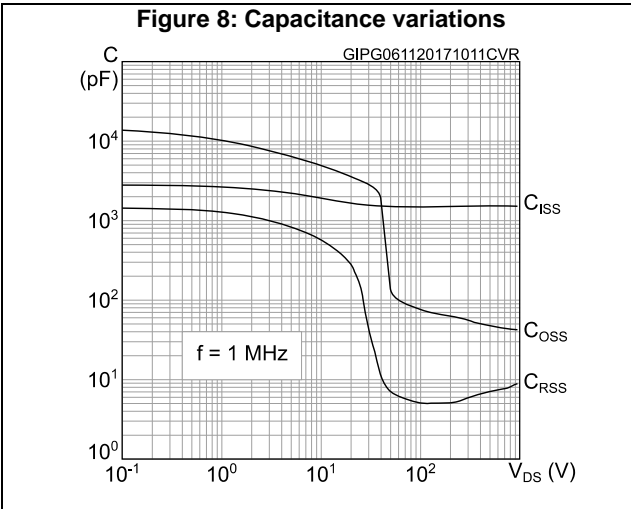
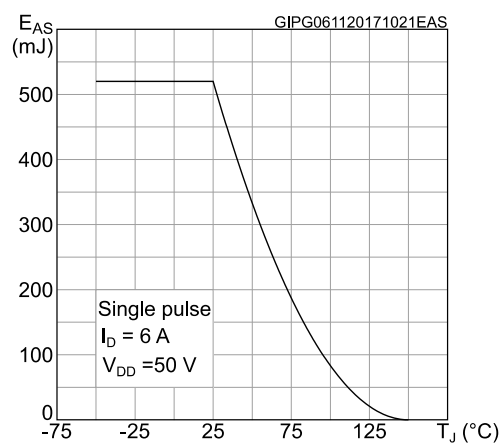

Figure 14: Maximum avalanche energy vs starting T_J



3 Test circuits

Figure 15: Test circuit for resistive load switching times



AM01468v1

Figure 16: Test circuit for gate charge behavior



AM01469v1

Figure 17: Test circuit for inductive load switching and diode recovery times

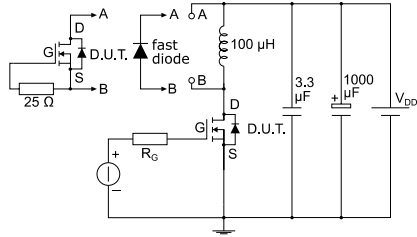

AM01470v1

Figure 18: Unclamped inductive load test circuit

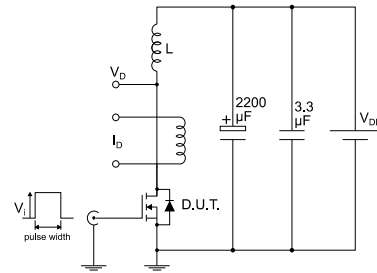

AM01471v1

Figure 19: Unclamped inductive waveform

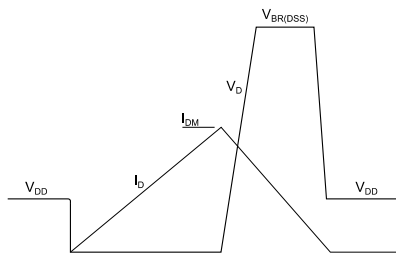

AM01472v1

Figure 20: Switching time waveform

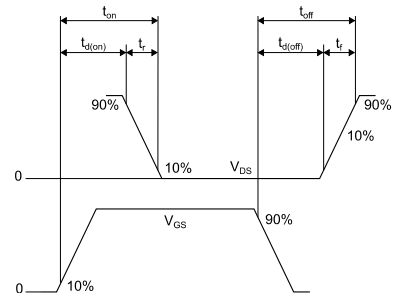

AM01473v1

4 Package information

In order to meet environmental requirements, ST offers these devices in different grades of ECOPACK® packages, depending on their level of environmental compliance. ECOPACK® specifications, grade definitions and product status are available at: www.st.com. ECOPACK® is an ST trademark.

4.1 TO-247 package information

Figure 21: TO-247 package outline

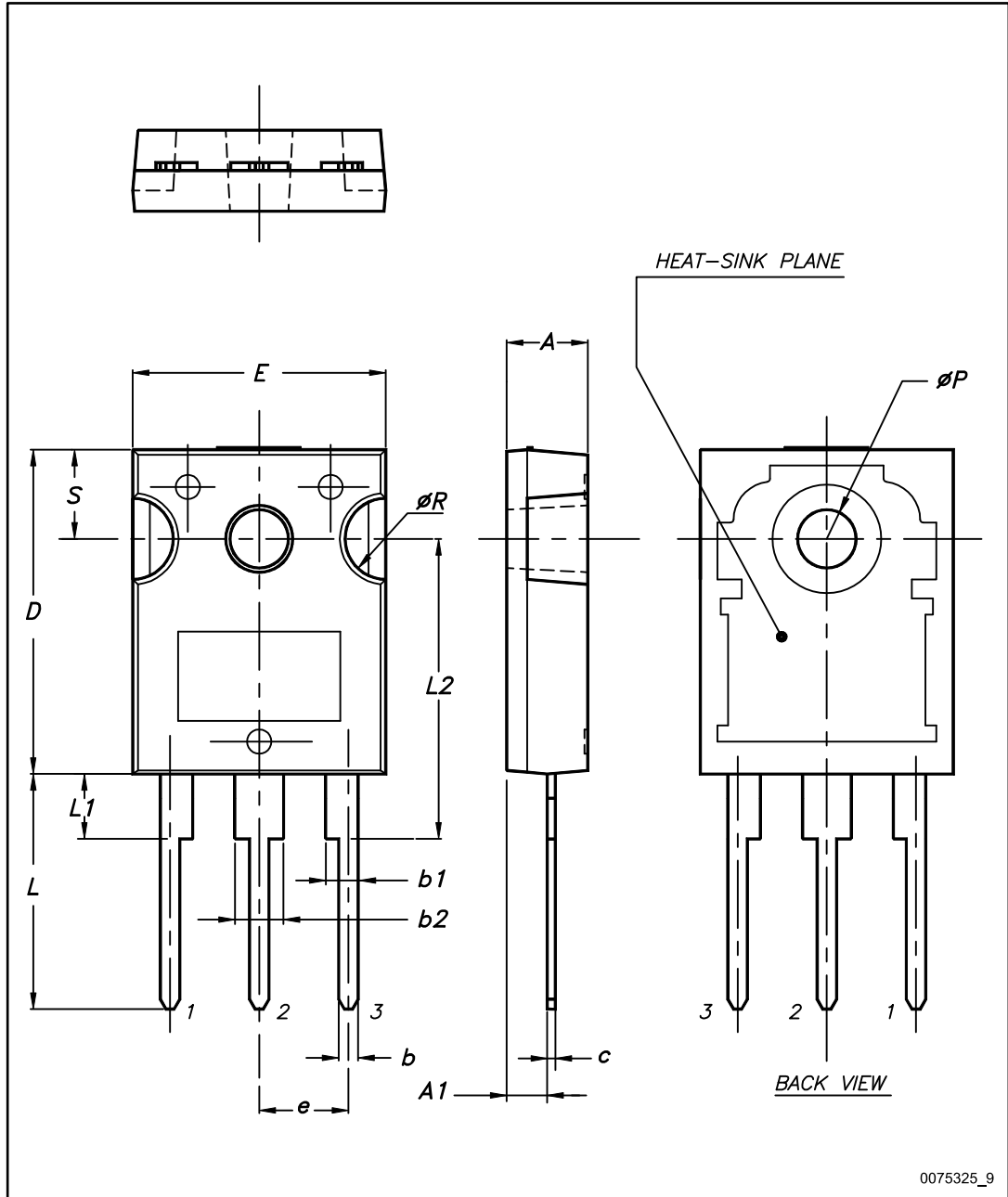

Table 9: TO-247 package mechanical data

Dim.	mm		
	Min.	Typ.	Max.
A	4.85		5.15
A1	2.20		2.60
b	1.0		1.40
b1	2.0		2.40
b2	3.0		3.40
c	0.40		0.80
D	19.85		20.15
E	15.45		15.75
e	5.30	5.45	5.60
L	14.20		14.80
L1	3.70		4.30
L2		18.50	
ØP	3.55		3.65
ØR	4.50		5.50
S	5.30	5.50	5.70

4.2 TO-247 long leads package information

Figure 22: TO-247 long leads package outline

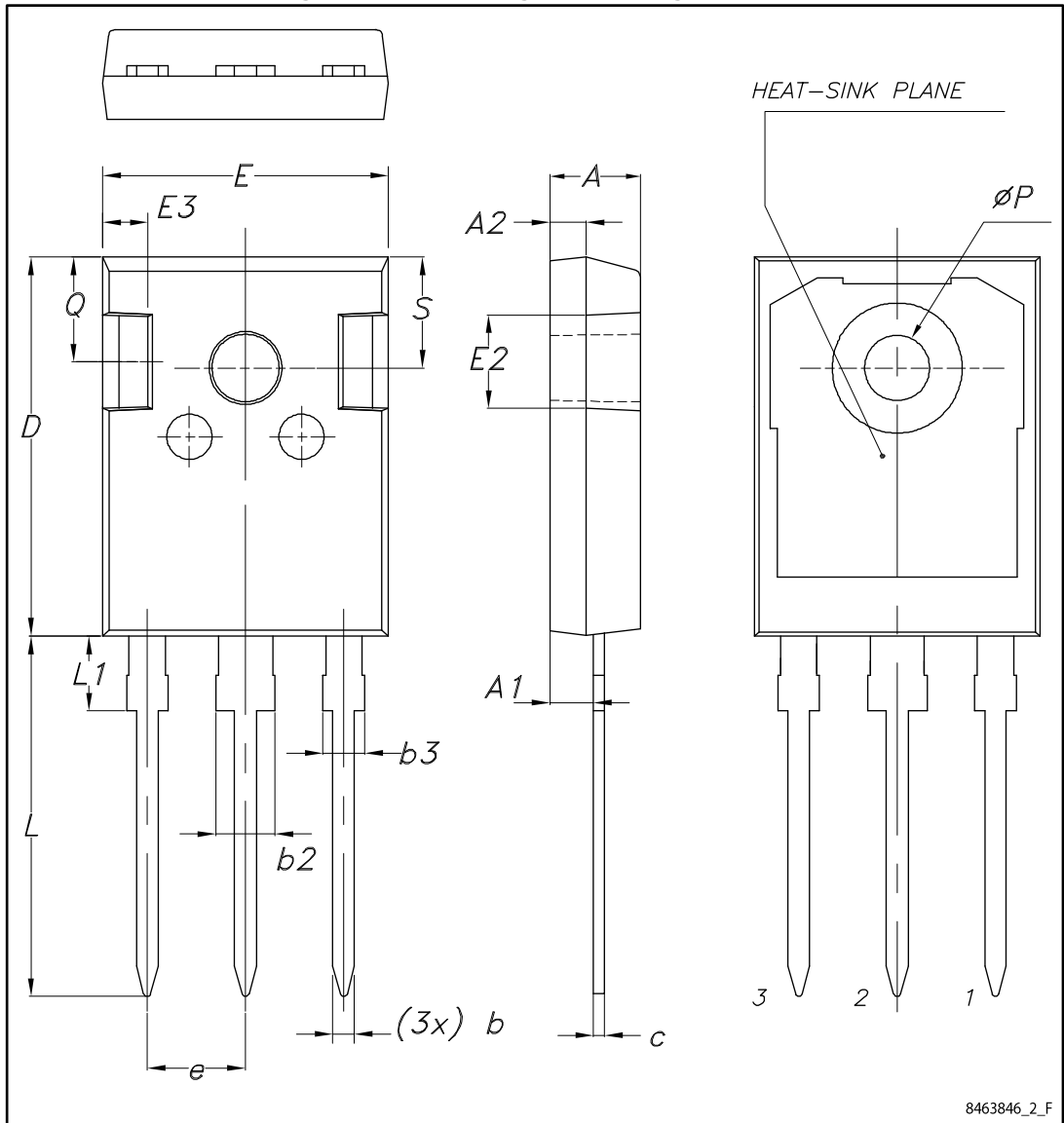

Table 10: TO-247 long leads package mechanical data

Dim.	mm		
	Min.	Typ.	Max.
A	4.90	5.00	5.10
A1	2.31	2.41	2.51
A2	1.90	2.00	2.10
b	1.16		1.26
b2			3.25
b3			2.25
c	0.59		0.66
D	20.90	21.00	21.10
E	15.70	15.80	15.90
E2	4.90	5.00	5.10
E3	2.40	2.50	2.60
e	5.34	5.44	5.54
L	19.80	19.92	20.10
L1			4.30
P	3.50	3.60	3.70
Q	5.60		6.00
S	6.05	6.15	6.25

5 Revision history

Table 11: Document revision history

Date	Revision	Changes
10-May-2017	1	Initial release
06-Nov-2017	2	Datasheet promoted from preliminary data to production data. Modified title and features table on cover page Modified Table 2: "Absolute maximum ratings" , Table 4: "Thermal data" , Table 5: "On/off states" , Table 6: "Dynamic" , Table 7: "Switching times" and Table 8: "Source-drain diode" . Added Section 2.1: "Electrical characteristics (curves)" . Minor text changes.

IMPORTANT NOTICE – PLEASE READ CAREFULLY

STMicroelectronics NV and its subsidiaries ("ST") reserve the right to make changes, corrections, enhancements, modifications, and improvements to ST products and/or to this document at any time without notice. Purchasers should obtain the latest relevant information on ST products before placing orders. ST products are sold pursuant to ST's terms and conditions of sale in place at the time of order acknowledgement.

Purchasers are solely responsible for the choice, selection, and use of ST products and ST assumes no liability for application assistance or the design of Purchasers' products.

No license, express or implied, to any intellectual property right is granted by ST herein.

Resale of ST products with provisions different from the information set forth herein shall void any warranty granted by ST for such product.

ST and the ST logo are trademarks of ST. All other product or service names are the property of their respective owners.

Information in this document supersedes and replaces information previously supplied in any prior versions of this document.

© 2017 STMicroelectronics – All rights reserved



Компания «ЭлектроПласт» предлагает заключение долгосрочных отношений при поставках импортных электронных компонентов на взаимовыгодных условиях!

Наши преимущества:

- Оперативные поставки широкого спектра электронных компонентов отечественного и импортного производства напрямую от производителей и с крупнейших мировых складов;
- Поставка более 17-ти миллионов наименований электронных компонентов;
- Поставка сложных, дефицитных, либо снятых с производства позиций;
- Оперативные сроки поставки под заказ (от 5 рабочих дней);
- Экспресс доставка в любую точку России;
- Техническая поддержка проекта, помощь в подборе аналогов, поставка прототипов;
- Система менеджмента качества сертифицирована по Международному стандарту ISO 9001;
- Лицензия ФСБ на осуществление работ с использованием сведений, составляющих государственную тайну;
- Поставка специализированных компонентов (Xilinx, Altera, Analog Devices, Intersil, Interpoint, Microsemi, Aeroflex, Peregrine, Syfer, Eurofarad, Texas Instrument, Miteq, Cobham, E2V, MA-COM, Hittite, Mini-Circuits, General Dynamics и др.);

Помимо этого, одним из направлений компании «ЭлектроПласт» является направление «Источники питания». Мы предлагаем Вам помощь Конструкторского отдела:

- Подбор оптимального решения, техническое обоснование при выборе компонента;
- Подбор аналогов;
- Консультации по применению компонента;
- Поставка образцов и прототипов;
- Техническая поддержка проекта;
- Защита от снятия компонента с производства.



Как с нами связаться

Телефон: 8 (812) 309 58 32 (многоканальный)

Факс: 8 (812) 320-02-42

Электронная почта: org@eplast1.ru

Адрес: 198099, г. Санкт-Петербург, ул. Калинина, дом 2, корпус 4, литера А.