

SERIES 82 Lightable

FEATURES

- $11/16$ " Between Button Centers
- Long, Stroke, Wiping Contact
- Lightable Modules
- Choice of 5 Circuitries with Unlighted Modules
- User Legenable



Lightable Modules



Unlighted Modules

MOUNTING

Build a custom keyboard with identical button distances no matter how you stack them. Designed to plug into any printed circuit board from $1/16$ " to $1/8$ " thick, modules stack in any configuration, maintaining $11/16$ " button centers.

For Lightable Modules which will be continuously lit, mixing vertically mounted modules with

horizontally mounted modules is not recommended; the orientation of the rectangular, lighted area will differ. See drawings.

See Figure 1 Panel Cutout diagram for 6 button module mounting dimensions. Refer to drawings for other module dimensions.

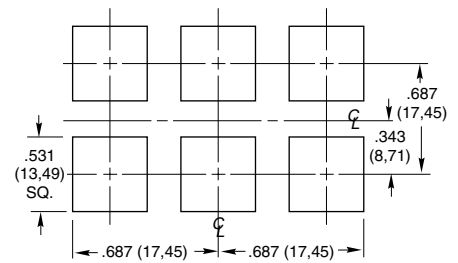

Figure 1 Panel Mount Cutout Diagram

LIGHTABLE MODULES

Light Source and Lamp Mounting

Each lightable button fits over a T-1 size LED or incandescent lamp mounted to PC board (see Figure 2-2a). The height of the lamp should not exceed $.250$ " (6.35 mm) from the surface of the board. (Note: Grayhill does not manufacture or sell LED's or incandescent lamps).

For easy light replacement, mount the lamp or LED through the back or solder side of the board (see Figure 2). This method of mounting allows you to replace light source without removing the keyboard module. The other method of light mounting (Figure 2a) requires

desoldering the keyboard module then desoldering the lamp when it's necessary to replace the light source.

The chart below lists ratings for a size T-1 incandescent lamp. To extend the life of the lamp, use an alternating current and reduced voltage. The chart also lists maximum temperatures the module can withstand. For higher temperatures, Grayhill offers modules made of special plastics, polyester switch housing and polycarbonate internal button. All measurements were determined under laboratory conditions. (Mounted model continuously lit in temperature controlled oven with continuously circulating air for 24 hours.)

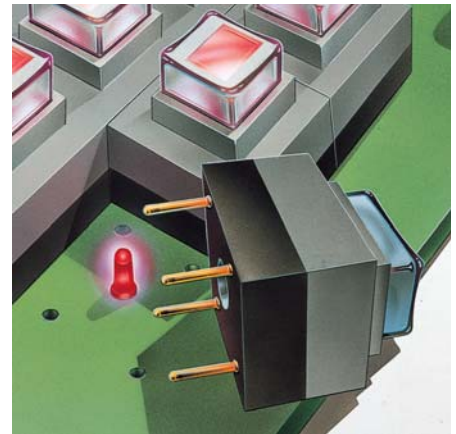

Incandescent Lamp—Size T-1

Lamp Number*	Intensity and Mean Spherical Candle Power	Volts	Service Life in Hours	Current Per Lamp	Maximum Allowable Ambient Temperature	Max. Temp. for Modules With Special Plastics
715	Bright .15 MSCP	5 V	40,000	115 mA	130°F	200°F
680	Moderate .03 MSCP	5 V	100,000	60 mA	150°F	220°F

*Lamps not available from Grayhill.

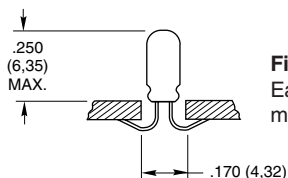

Figure 2
Easy replacement mounting

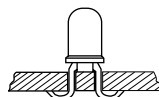
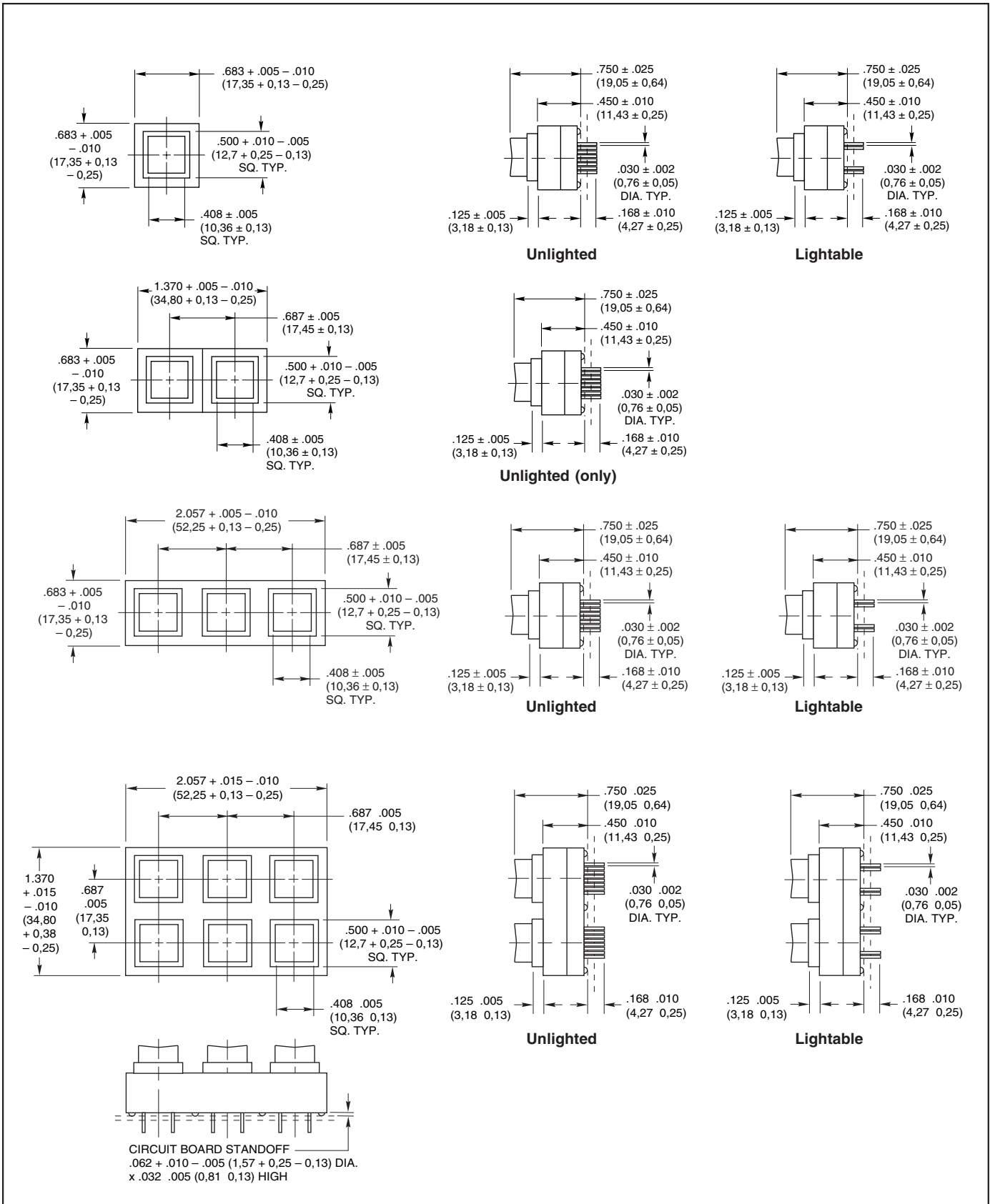

Figure 2a
Mounted from component side

DIMENSIONS In inches (and millimeters)



Keyboards and Keypads

TERMINAL ARRANGEMENTS

For continuously lit keyboards, mixing horizontally and vertically mounted modules is not recommended. See lamp mounting on page D-33.

Letters shown in front views are for identification only; product is marked on back as shown. Pin locations correspond to circuit diagrams.

Vertical Mount

Button Identification

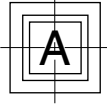

Rear Views and Pin Locations

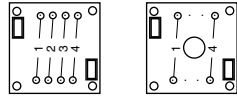

Unlighted Lightable

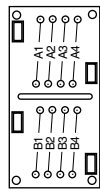
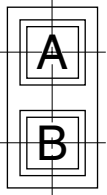

Unlighted (only)

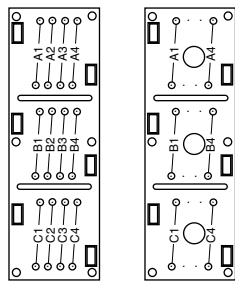
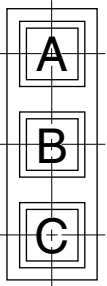

Unlighted Lightable

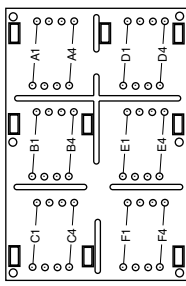
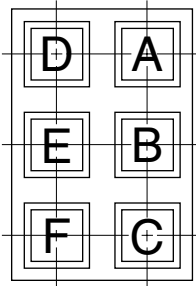

Unlighted

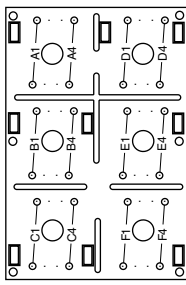

Lightable

Horizontal Mount

Button Identification

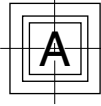

Rear Views and Pin Locations

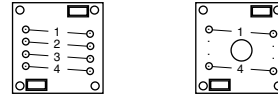

Unlighted Lightable

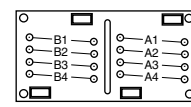
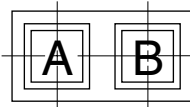

Unlighted (only)

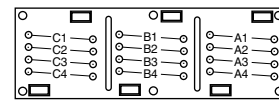
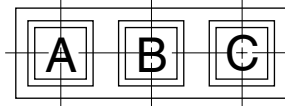

Unlighted

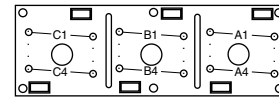

Lightable

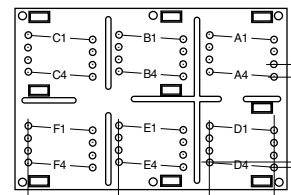
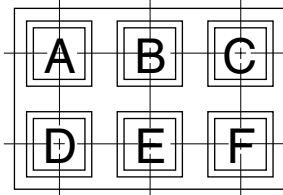

Unlighted

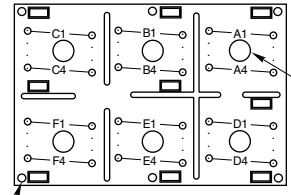

Lightable

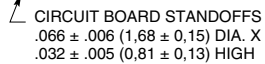
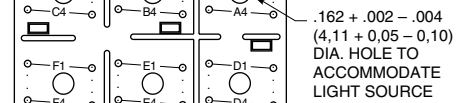
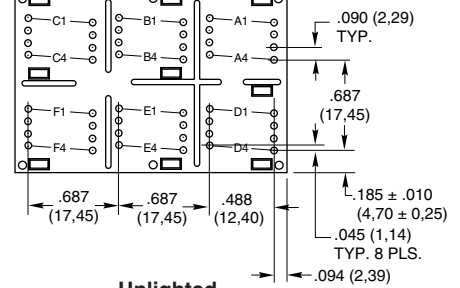

ORIENTATION OF MODULES

A module, depending on circuitry, may not be symmetrical. Rotating it 180° will result in a different pin location. Please note the button

identification, the pin location for the desired circuitry, and the direction of mounting. It is important to use this information when designing a printed circuit board layout and when

communicating with Grayhill. See Ordering Information—Special Keyboard Modules on the next page.

CIRCUIT DIAGRAMS

The bottom view of the line drawings shows number (A1, A2, etc.) next to the pin locations of each switch section. These pin numbers are directly related to the circuit diagrams. For example, if the switch under Button A of a standard module were SPST, the pins would be located at the "#2" Position. If the module were a lightable one with SPST circuitry, the pins would be located at the "#1" Position. If other locations are desired, specify them.

The coded circuits shown are suggested possibilities and each button may carry a different circuit. Location of active pins on each button may be varied to conform with layout of the printed circuit board. Up to a 7-bit code is possible under each button.

Combinations of simple circuitries are also possible as shown in the sample diagrams.

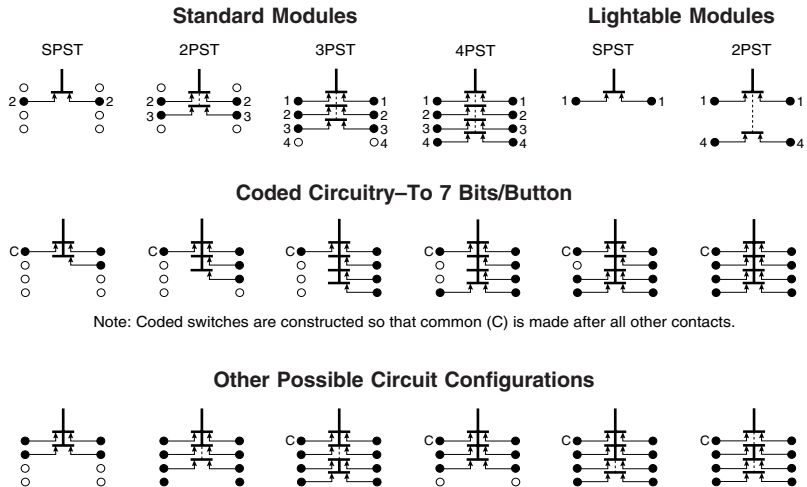

PRINTED CIRCUIT BOARD LAYOUT

This layout provides the horizontal printed circuit board layout as viewed from the top side of the PC board. Turning end to end will result in a different pin location. However, the dimensional relationship will remain the same.

Lightable Modules—per drawing below.

This drawing indicates the layout to be used for a 6 button module with light sources mounted two ways: the lamps for the upper 3 buttons are mounted from the top or component side of the board, and the lamps for the lower 3 buttons are mounted by the easy replacement method. (See also Light Source and Lamp Mounting.) Light sources, when mounted from the top side of the board, must be mounted before the keyboard modules; when mounted, lamp should extend no more than .250" (6,35 mm) above the board.

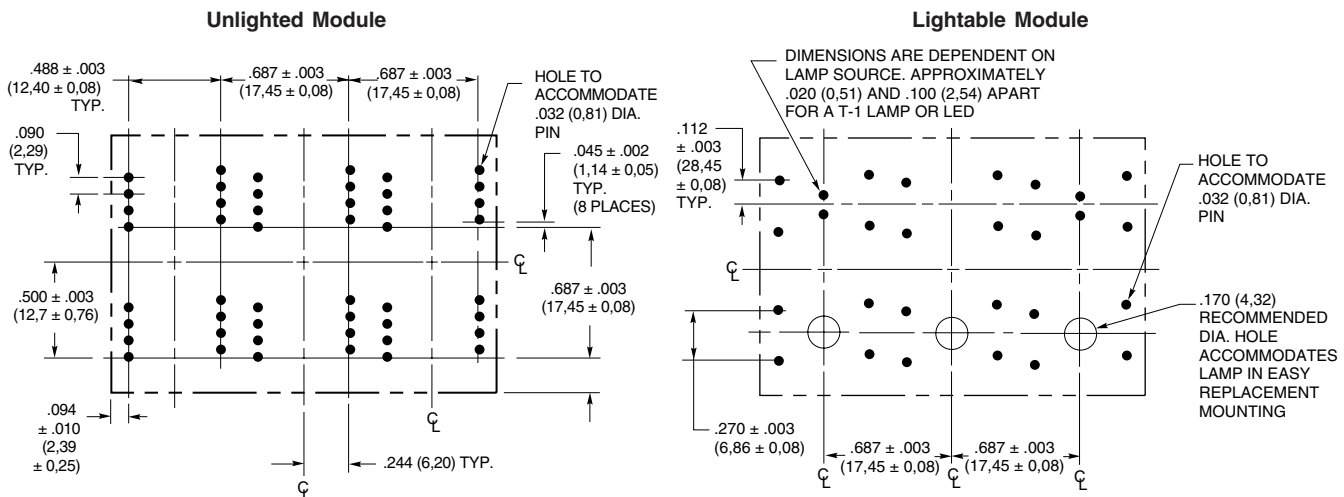

Keyboards and Keypads

SPECIFICATIONS

Rating

- Rating at 5 Vdc:** 100 milliamps
- Contact Resistance:** 25 milliohms or less on a new switch
- Voltage Breakdown:** 250 Vac between mutually insulated parts
- Insulation Resistance:** 1,000 megaohms minimum
- Life Expectancy:** 1,000,000 operations
- Contact Bounce:** 10 milliseconds or less for the life of the switch
- Operating Temperature:** -40°C to 80°C

Materials and Finishes

Pin Contact: Brass, gold plate over nickel plate

- Spring Contact:** Copper alloy, gold plate over nickel plate
- Housing:** ABS plastic (gray)
- Base:** PPS plastic (black)
- Return Spring:** Tinned music wire
- Other Parts:** (By Module and Legend Style): For unlighted module with molded legends or top surface printed legends. Internal Button is acetal and the Button is ABS plastic (gray).

For unlighted module with sub-surface printed legends or insertable legends, Internal Button is acetal; Internal Cap is ABS plastic (gray); and Clear Cap is polycarbonate plastic. For lightable modules, the Internal Button and the Clear Cap are polycarbonate. The Internal Cap for gray modules is acrylic; for the black modules, the Internal Cap with window is polycarbonate.

For special lightable modules for higher temperatures, internal button cap is polycarbonate and housing is polyester.

Operating Features

- Action:** Momentary, wiping contact
- Button Travel:** 0.130" (3,30 mm) total travel
- Overtravel:** 0.080" nominal
- Operating Force:** 8 ± 3 ounces (depends on number of poles.)

Soldering Instructions

Series 82 Keyboard Modules have been successfully tested for heat resistance to soldering up to 260°C (500°F) for a maximum of 5 seconds. Careful flux cleaning is required since the switch is not sealed. For applications in excess of these limits or that require vapor spray or immersion cleaning, contact Grayhill.

STANDARD LEGENDS

Telephone Keypad



Two 6-button modules form the keypad. White telephone legend is molded into a gray button. SPST, 2PST, 3PST, and 4PST circuitry available from distributors, see ordering information; order special circuitry from Grayhill.

Insertable Legend Styles

Prototypes can look professional with insertable legend modules. Just slip imprinted legend insert through the slot of the clear button cap.

Legend Sheet

Available for each module style. Each sheet contains commonly used symbols, terms, alpha characters, and 0-19 in News Gothic Condensed type on polyester film, ready to be cut and inserted. Deadfront legends are invisible until lit.



Non-Legend, Lighted Modules

Standard lightable module configurations without cap slot for insertable legend.

- White on Clear:** For unlighted gray modules
- Black on Clear:** For lighted gray modules
- Translucent White on Black:** For black modules
- Deadfront on Black:** For black modules

- Part No. 82AC2017-1**
- Part No. 82AC2050-1**
- Part No. 82AC2060**

SPECIAL LEGENDS

Molded-In Legends

For Unlighted Modules

In addition to standard white legend on gray button, long-wearing, molded-in legends are available in white button with black legend and white legend with red, green or black buttons. Other color combinations are possible.



Printed Type styles

The type style chart below illustrates type style and approximate sizes and limits for button cap legends; other sizes are also available. Limitations for legends differ with type size and character. Legends for lightable modules are further limited by the size of the internal button and lighted area. Grayhill's library includes many popular legends. Contact Grayhill for complete information.

Special Colors

Besides the standard gray and black housings, you may order white, beige or brown. Button colors may also be specially ordered. For more information, see next page.



Printed Legends (2 Styles)

Virtually anything which can be photographed can be printed. Sturdy epoxy ink printing bonds to the surface of the button. Standard printing for the gray unlighted buttons is white; standard printing for the translucent white buttons of the lightable modules is black.

Top Surface Printing: Legend is applied directly to top of button. Available on all standard, unlighted modules.

Sub Surface Printing: Provides maximum wear for printed surfaces. Available for lighted and unlighted gray modules. Printed internal button cap is protected by a clear outer cap.

Type No. and Typical Height	Sample Style and Typical Sizes	Sub Surface Character and Line Limitations	Top Surface Character and Line Limitations	Lightable Module Character and Line Limitations*
4GH088 .083"	ABCDEFGH	5 Char. 2 Lines TAB INDEX	8 Char. 3 Lines RESEARCH SYSTEMS 12345678	4 Char. 2 Lines STOP 1234
1GH125 .138"	ABCDE	4 Char. 1 Line OPER	4 Char. 2 Lines CODE SEND	3 Char. 1 Line OFF
3GH187 .207"	ABCD	2 Char. 1 Line ON	3 Char. 1 Line OFF	2 Char. 1 Line ON
2GH250 .276"	ABC	2 Char. 1 Line 15	2 Char. 1 Line 15	N/A N/A

Note: Limitations for legends differ with surface to be printed and actual characters. If your application exceeds the approximations in the chart, contact Grayhill for more information.
* For top and sub-surface printed modules.

ORDERING INFORMATION:

Special Legends

To order non-standard modules, information is required for the areas listed below.

Your special order will be assigned a part number for future identification. This number is sequentially assigned and is non-descriptive.

1. Type of Module. Unlighted: 1-, 2-, 3-, or 6-button. Lightable: 1-, 3-, or 6-button.

2. Mounting Orientation. Horizontal or vertical.

3. Circuitry. Requirements for each button must be listed by its reference letter designation. For example: Button A = SPST, Button B = 4PST, Button C = 3PST, etc. For coded or other available circuitry patterns a descriptive diagram is required for each button.

4. Button Type (Legend). Grayhill offers four legend types: molded-in; top surface printed; sub-surface printed; and insertable. Unlighted modules are available in all types. Lightable modules are available in all types but molded-in legends.

5. Button Color. Standard color for molded-in legend modules is gray button with white legend. Special button colors available are white with black legends, red, green or black buttons with white legends. Additional custom colors are available by special order.

Lightable gray modules have a standard translucent white button with black legend. Special button color includes translucent red, amber, yellow, blue and green. Lightable black modules have a special opaque black button; discuss special colors with Grayhill.

Colors can be intermixed, ie. buttons A-E gray; and F, white.

6. Housing Color. Base in black. Upper housing is black for lightable legends and gray for all other module styles. Other stock colors available include white, beige and brown.

7. Legends. List legend requirement for each button (Button A legend, "10", is type style 4GH088. Button B, "ON", is type style 1GH125, etc.). For legend information, see page D-37.

Price: Contact Grayhill

ORDERING INFORMATION: STANDARD MODULES

Type of Module	Description	Part No.
Top Half of Telephone Legend (Molded-in)	6 Buttons, SPST	82-601-85
	6 Buttons, 2PST	82-601-86
	6 Buttons, 3PST	82-601-87
	6 Buttons, 4PST	82-601-88
Bottom of Telephone Legend (Molded-in)	6 Buttons, SPST	82-601-89
	6 Buttons, 2PST	82-601-90
	6 Buttons, 3PST	82-601-91
	6 Buttons, 4PST	82-601-92
Unlighted Gray Modules For Legend Inserts	1 Button, SPST	82-101-71
	1 Button, 4PST	82-101-74
	2 Buttons, SPST	82-201-41
	2 Buttons, 4PST	82-201-44
	3 Buttons, SPST	82-301-61
	3 Buttons, 4PST	82-301-64
	6 Buttons, SPST	82-601-81
	6 Buttons, 4PST	82-601-84
Lightable Gray Modules Non-Legend	1 Button, SPST	82-150-17
	1 Button, 2PST	82-150-15
	3 Buttons, SPST	82-350-10
	3 Buttons, 2PST	82-350-8
	6 Buttons, SPST	82-650-10
	6 Buttons, 2PST	82-650-8
Lightable Gray Modules For Legend Inserts	1 Button, SPST	82-150-38
	1 Button, 2PST	82-150-16
	3 Buttons, SPST	82-350-12
	3 Buttons, 2PST	82-350-9
	6 Buttons, SPST	82-650-19
	6 Buttons, 2PST	82-650-9
Lightable Black Modules For Legend Inserts	1 Button, SPST	82-150-211
	1 Button, 2PST	82-150-213
	3 Buttons, SPST	82-350-41
	3 Buttons, 2PST	82-350-43
	6 Buttons, SPST	82-650-71
	6 Buttons, 2PST	82-650-73
Legend Sheets	White: For Unlighted Gray Black: For Lightable Gray Deadfront: For Lightable Black	82AC2017-1 82AC2050-1 82AC2060

Available from your local Grayhill Distributor. For prices and discounts, contact a local Sales Office, an authorized local Distributor or Grayhill.

Keyboards and Keypads



Компания «ЭлектроПласт» предлагает заключение долгосрочных отношений при поставках импортных электронных компонентов на взаимовыгодных условиях!

Наши преимущества:

- Оперативные поставки широкого спектра электронных компонентов отечественного и импортного производства напрямую от производителей и с крупнейших мировых складов;
- Поставка более 17-ти миллионов наименований электронных компонентов;
- Поставка сложных, дефицитных, либо снятых с производства позиций;
- Оперативные сроки поставки под заказ (от 5 рабочих дней);
- Экспресс доставка в любую точку России;
- Техническая поддержка проекта, помощь в подборе аналогов, поставка прототипов;
- Система менеджмента качества сертифицирована по Международному стандарту ISO 9001;
- Лицензия ФСБ на осуществление работ с использованием сведений, составляющих государственную тайну;
- Поставка специализированных компонентов (Xilinx, Altera, Analog Devices, Intersil, Interpoint, Microsemi, Aeroflex, Peregrine, Syfer, Eurofarad, Texas Instrument, Miteq, Cobham, E2V, MA-COM, Hittite, Mini-Circuits, General Dynamics и др.);

Помимо этого, одним из направлений компании «ЭлектроПласт» является направление «Источники питания». Мы предлагаем Вам помощь Конструкторского отдела:

- Подбор оптимального решения, техническое обоснование при выборе компонента;
- Подбор аналогов;
- Консультации по применению компонента;
- Поставка образцов и прототипов;
- Техническая поддержка проекта;
- Защита от снятия компонента с производства.



Как с нами связаться

Телефон: 8 (812) 309 58 32 (многоканальный)

Факс: 8 (812) 320-02-42

Электронная почта: org@eplast1.ru

Адрес: 198099, г. Санкт-Петербург, ул. Калинина, дом 2, корпус 4, литера А.