

Slide Potentiometer

Model PSxxM / PSxxL



Features:

- Molded element
- 100,000 cycle life
- Metal or plastic shaft options
- With/without LED illumination
- With/without dust cover
- RoHS compliant

Model Styles Available

| | |
|-----------------------|-------|
| Dual Gang Without LED | PSxxM |
| Single Gang With LED | PSxxL |

Electrical

| | |
|---|---|
| Resistance Range, Ohms | 500 -1M |
| Standard Resistance Tolerance | ± 20% |
| Resistance Tapers | A,B,C |
| Residual Resistance | Terminals 1 to 2: Less than 10 ohms Terminals 2 to 3: Less than 30 ohms |
| Input Voltage, Maximum | Linear B taper: 200 Vac Other tapers: 150 Vac |
| Power rating, Watts (Single Unit / Dual Unit) | Linear B taper: 20mm: 0.1W / 0.05W, 30mm: 0.2W / 0.1W 45mm: 0.25W / 0.125W, 60mm: 0.2W / 0.2W Other tapers: 20mm: 0.05W / 0.025W, 30mm: 0.1W / 0.05W 45mm: 0.125W / 0.06W, 60mm: 0.1W / 0.1W |
| Dielectric Strength | 300Vac, 1 minute |
| Insulation Resistance, Minimum | 10M ohms at 250Vdc/ 1 minute |
| Sliding Noise | Less than 100mV |
| Gang Error | ±3dB (-40dB to 0dB) |

Mechanical

| | |
|-------------------------------|---------------|
| Static Stop Strength, Minimum | 5.0 Kg/cm |
| Operating Force | 10gf to 100gf |
| Detent Slip-out force | 30gf to 200gf |

Durability

| | |
|--------------|----------------|
| Sliding Life | 100,000 cycles |
|--------------|----------------|

General Note

TT Electronics reserves the right to make changes in product specification without notice or liability. All information is subject to TT Electronics' own data and is considered accurate at time of going to print.

TT Electronics | BI Technologies
4200 Bonita Place, Fullerton, CA USA 92835 | Ph: +1 714 447 2345
www.ttelectronics.com | sensors@ttelectronics.com

Slide Potentiometer

Model PSxxM / PSxxL



Ordering

Model PSxxM (Without LED)



Model PSxxL (With LED)



Standard Resistance Values, ohms

| | | | | | | | | | | |
|-----|----|----|----|-----|-----|-----|------|------|------|-------|
| 500 | 1K | 2K | 5K | 10K | 20K | 50K | 100K | 200K | 500K | 1 MEG |
|-----|----|----|----|-----|-----|-----|------|------|------|-------|

General Note

TT Electronics reserves the right to make changes in product specification without notice or liability. All information is subject to TT Electronics' own data and is considered accurate at time of going to print.

Slide Potentiometer

Model PSxxM / PSxxL



Tapers

For Dual Gang units ONLY, the Standard Taper is a 3B taper
If Linear Taper is desired, use "L" taper option

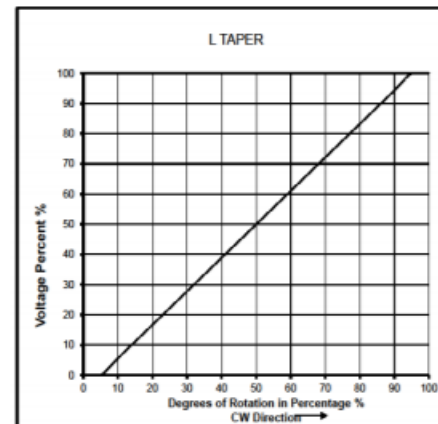
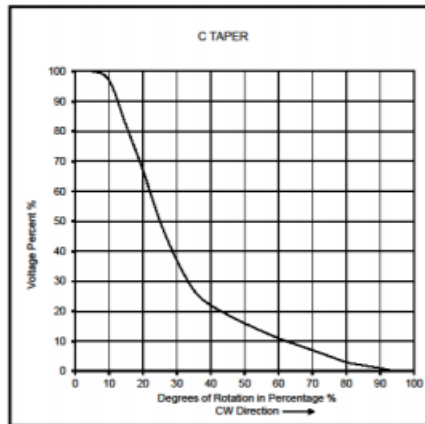
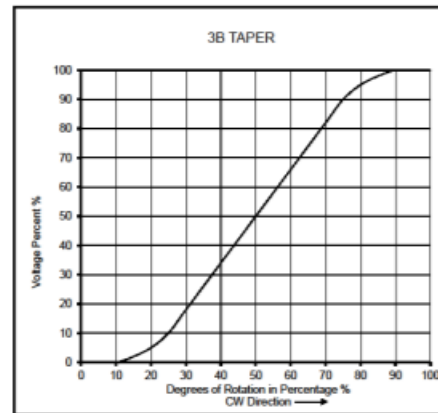
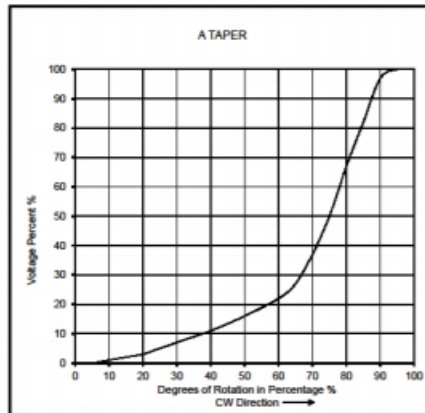

General Note

TT Electronics reserves the right to make changes in product specification without notice or liability. All information is subject to TT Electronics' own data and is considered accurate at time of going to print.

TT Electronics | BI Technologies
4200 Bonita Place, Fullerton, CA USA 92835 | Ph: +1 714 447 2345
www.ttelectronics.com | sensors@ttelectronics.com

Slide Potentiometer

Model PSxxM / PSxxL



Outline Drawings

Plastic Lever Types (For PSxxM Only)

| E-Type | | B-Type | | C-Type | | D-Type | | |
|--------|-----|--------|----|--------|-------|--------|----------|--|
| | | | | | | | | |
| L | 5.0 | L | 15 | L | 10 15 | L | 10 15 20 | |
| CODE | 1 | CODE | 1 | CODE | 1 2 | CODE | 1 2 3 | |

Dust Cover option not offered for levers less than 10 mm in length

Metal Lever Types (For PSxxM Only)

| D-Type | | | | C-Type | | | | E-Type | | |
|--------|----|----|----|--------|---|----|----|--------|------|---|
| | | | | | | | | | | |
| L | 15 | 20 | 25 | F | 5 | 10 | 10 | L | 7.6 | |
| CODE | 1 | 2 | 3 | CODE | 1 | 2 | 3 | 4 | CODE | 1 |

*** Dust Cover option not offered for levers less than 10 mm in length**

General Note

TT Electronics reserves the right to make changes in product specification without notice or liability. All information is subject to TT Electronics' own data and is considered accurate at time of going to print.

TT Electronics | BI Technologies
 4200 Bonita Place, Fullerton, CA USA 92835 | Ph: +1 714 447 2345
www.ttelectronics.com | sensors@ttelectronics.com

Slide Potentiometer

Model PSxxM / PSxxL



Outline Drawings

Model PSxxM (Without LED)



For PSxxM and PSxxL

| MODEL | A | B | C | D | F | G |
|-------------|----|----|----|----|------|------|
| PS20M PS20L | 35 | 31 | 20 | 30 | 5 | 12.5 |
| PS30M PS30L | 45 | 41 | 30 | 40 | 10 | 22.5 |
| PS45M PS45L | 60 | 56 | 45 | 55 | 15 | 32.5 |
| PS60M PS60L | 75 | 71 | 60 | 70 | 22.5 | 47.5 |

General Note

TT Electronics reserves the right to make changes in product specification without notice or liability. All information is subject to TT Electronics' own data and is considered accurate at time of going to print.

TT Electronics | BI Technologies
 4200 Bonita Place, Fullerton, CA USA 92835 | Ph: +1 714 447 2345
 www.ttelectronics.com | sensors@ttelectronics.com

Slide Potentiometer

Model PSxxM / PSxxL



Outline Drawings

Model PSxxL (With LED)

With Dust Cover



Without Dust Cover



| | | |
|------|----|----|
| L | 15 | 19 |
| CODE | 1 | 2 |



FRAME OPTION (F)



PSxxL (Single gang with LED)



PSxxM (Dual gang)



General Note

TT Electronics reserves the right to make changes in product specification without notice or liability. All information is subject to TT Electronics' own data and is considered accurate at time of going to print.

TT Electronics | BI Technologies
4200 Bonita Place, Fullerton, CA USA 92835 | Ph: +1 714 447 2345
www.ttelectronics.com | sensors@ttelectronics.com



Компания «ЭлектроПласт» предлагает заключение долгосрочных отношений при поставках импортных электронных компонентов на взаимовыгодных условиях!

Наши преимущества:

- Оперативные поставки широкого спектра электронных компонентов отечественного и импортного производства напрямую от производителей и с крупнейших мировых складов;
- Поставка более 17-ти миллионов наименований электронных компонентов;
- Поставка сложных, дефицитных, либо снятых с производства позиций;
- Оперативные сроки поставки под заказ (от 5 рабочих дней);
- Экспресс доставка в любую точку России;
- Техническая поддержка проекта, помощь в подборе аналогов, поставка прототипов;
- Система менеджмента качества сертифицирована по Международному стандарту ISO 9001;
- Лицензия ФСБ на осуществление работ с использованием сведений, составляющих государственную тайну;
- Поставка специализированных компонентов (Xilinx, Altera, Analog Devices, Intersil, Interpoint, Microsemi, Aeroflex, Peregrine, Syfer, Eurofarad, Texas Instrument, Miteq, Cobham, E2V, MA-COM, Hittite, Mini-Circuits, General Dynamics и др.);

Помимо этого, одним из направлений компании «ЭлектроПласт» является направление «Источники питания». Мы предлагаем Вам помощь Конструкторского отдела:

- Подбор оптимального решения, техническое обоснование при выборе компонента;
- Подбор аналогов;
- Консультации по применению компонента;
- Поставка образцов и прототипов;
- Техническая поддержка проекта;
- Защита от снятия компонента с производства.



Как с нами связаться

Телефон: 8 (812) 309 58 32 (многоканальный)

Факс: 8 (812) 320-02-42

Электронная почта: org@eplast1.ru

Адрес: 198099, г. Санкт-Петербург, ул. Калинина, дом 2, корпус 4, литера А.