

DUAL OPERATIONAL AMPLIFIER

■ GENERAL DESCRIPTION

The NJM8065 integrated circuit is a high-gain, wide bandwidth, dual operational amplifier.

The NJM8065 combines many of the features of the NJM4558 as well as providing the capability of wider bandwidth (10MHz typ.), and higher slew rate (4V/μs typ.) make the NJM8065 ideal for active filters, data and telecommunications, and many instrumentation applications.

■ PACKAGE OUTLINE



NJM8065G
(SOP8)



NJM8065M
(DMP8)



NJM8065RB1
(MSOP8 (TVSP8))



NJM8065V
(SSOP8)

■ FEATURES

- Operating Voltage ±4V to ±18V
- Wide Gain Bandwidth Product 10MHz typ.
- Slew Rate 4V/μs typ.
- Package Outline SOP8, DMP8
MSOP8 (TVSP8)*
*MEET JEDEC MO-187-DA / THIN TYPE
SSOP8
- Bipolar Technology
- Internal ESD protection
Human body model (HBM) ±2000V typ.
- Wide temperature range -40°C to +125°C

■ PIN CONFIGURATION

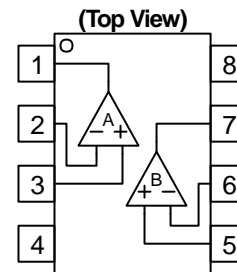

- PIN FUNCTION**
- 1.A OUTPUT
 - 2.A - INPUT
 - 3.A + INPUT
 - 4.V⁻
 - 5.B + INPUT
 - 6.B - INPUT
 - 7.B OUTPUT
 - 8.V⁺

NJM8065G
NJM8065M
NJM8065RB1
NJM8065V

■ EQUIVALENT CIRCUIT (1/2 Shown)

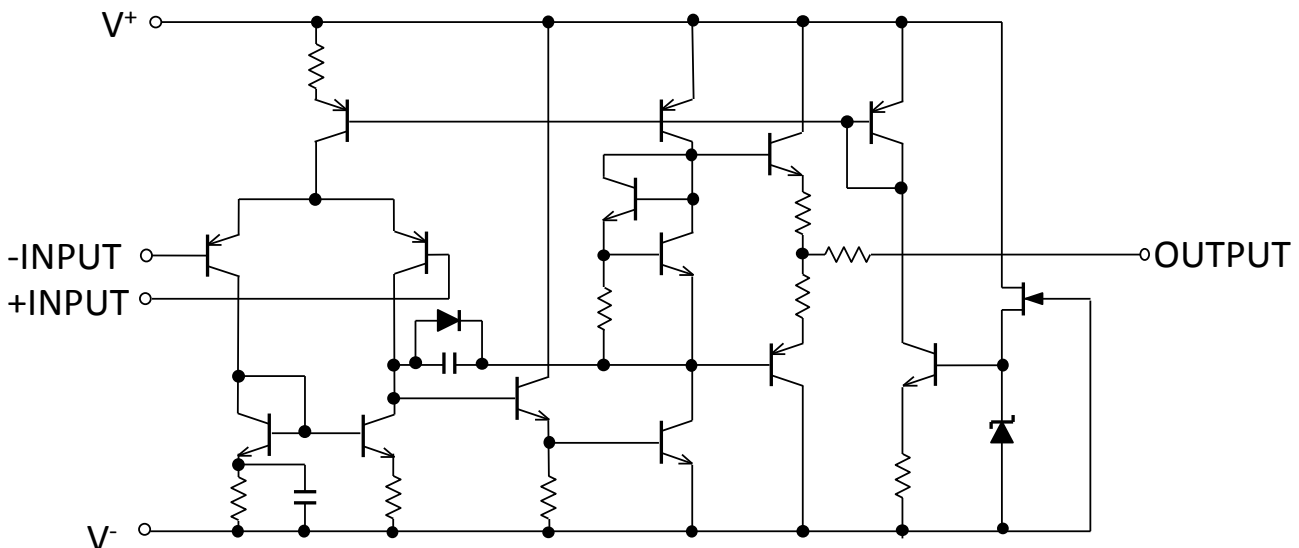

NJM8065

■ ABSOLUTE MAXIMUM RATINGS (Ta=25°C, unless otherwise noted.)

PARAMETER	SYMBOL	RATINGS	UNIT
Supply Voltage	V ⁺ /V ⁻	±18	V
Differential Input Voltage (Note1)	V _{ID}	±36	V
Input Voltage (Note2)	V _{IN}	V ⁻ -0.3 to V ⁺ +36	V
Output Terminal Input Voltage	V _O	V ⁻ -0.3 to V ⁺ +0.3	V
Power Dissipation	P _D	SOP : 690(Note3) 1000(Note4) DMP : 470(Note3) 600(Note4) MSOP : 510(Note3) 680(Note4) SSOP : 430 (Note3) 540(Note4)	mW
Operating Temperature Range	T _{opr}	-40~+125	°C
Storage Temperature Range	T _{stg}	-65~+150	°C

(Note1) Differential voltage is the voltage difference between +INPUT and -INPUT.

(Note2) Input voltage is the voltage should be allowed to apply to the input terminal independent of the magnitude of V⁺.

The normal operation will establish when any input is within the Common Mode Input Voltage Range of electrical characteristics.

(Note3) EIA/JEDEC STANDARD Test board (76.2 x 114.3 x 1.6mm, 2layers, FR-4) mounting

(Note4) EIA/JEDEC STANDARD Test board (76.2 x 114.3 x 1.6mm, 4layers, FR-4) mounting

■ RECOMMENDED OPERATING CONDITIONS (Ta=25°C)

PARAMETER	SYMBOL	CONDITION	MIN.	TYP.	MAX.	UNIT
Supply Voltage	V ⁺ /V ⁻		±4	-	±18	V

■ ELECTRICAL CHARACTERISTICS (V⁺/V⁻=±15V, Ta=25°C, unless otherwise noted.)

PARAMETER	SYMBOL	TEST CONDITION	MIN.	TYP.	MAX.	UNIT
Input Offset Voltage	V _{IO}	R _S ≤10kΩ	-	0.5	3	mV
Input Offset Current	I _{IO}		-	2	50	nA
Input Bias Current	I _B		-	50	200	nA
Input Resistance	R _{IN}		-	1	-	MΩ
Large Signal Voltage Gain	A _V	R _L ≥2kΩ, V _O =±10V	86	100	-	dB
Maximum Output Voltage Swing 1	V _{OM1}	R _L ≥2kΩ	± 12	± 14	-	V
Maximum Output Voltage Swing 2	V _{OM2}	I _O =25mA	± 10	± 11.5	-	V
Input Common Mode Voltage Range	V _{ICM}		± 12	± 14	-	V
Common Mode Rejection Ratio	CMR	R _S ≤10kΩ	70	95	-	dB
Supply Voltage Rejection Ratio	SVR	R _S ≤10kΩ	76.5	100	-	dB
Operating Current	I _{CC}		-	4.5	7	mA
Slew Rate	SR		-	4	-	V/μs
Gain Bandwidth Product	GBP	f=10kHz	-	10	-	MHz
Equivalent Input Noise Voltage	e _n	f=1kHz	-	8	-	nV/√Hz

TYPICAL CHARACTERISTICS

Gain/Phase vs. Frequency

$V^+/V^- = \pm 15V$, $R_L = 2k\Omega$, $G_V = 40dB$

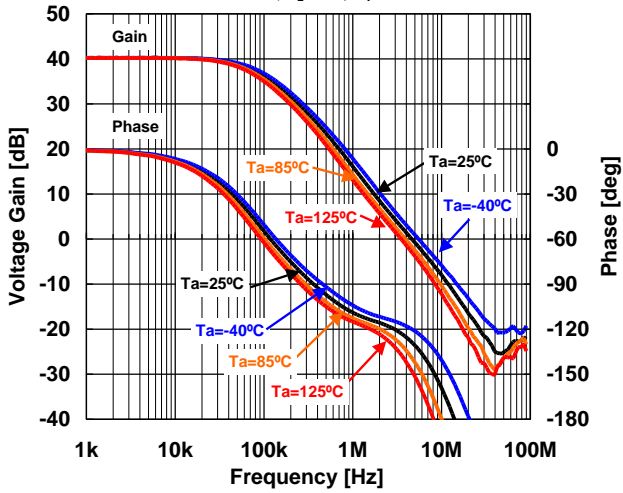

Maximum Output Voltage Swing vs. Frequency

$V^+/V^- = \pm 15V$, $R_L = 2k\Omega$, $T_a = 25^\circ C$

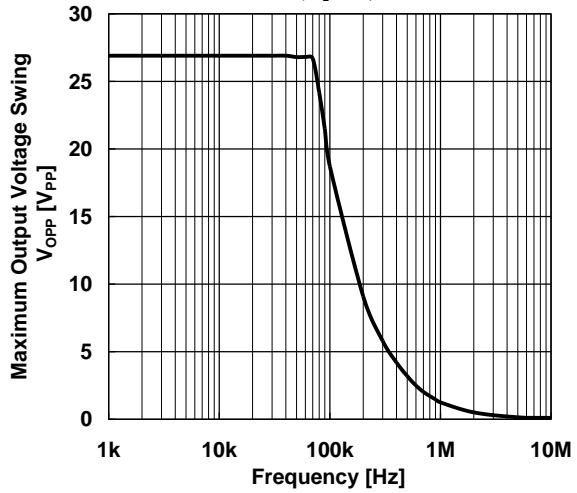

Maximum Output Voltage Swing vs. Load Resistance

$V^+/V^- = \pm 15V$, $T_a = 25^\circ C$

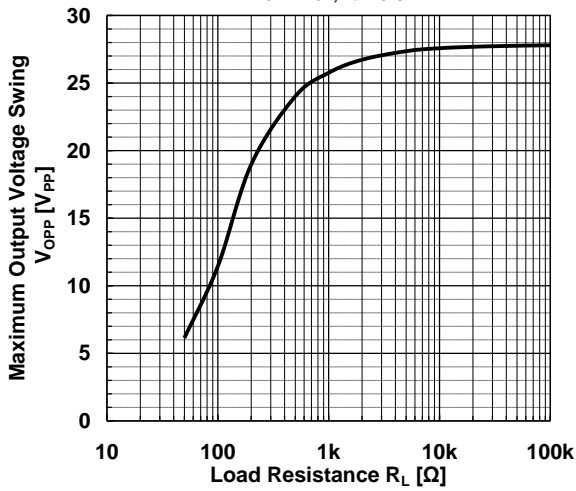

Maximum Output Voltage vs. Load Resistance

$V^+/V^- = \pm 15V$

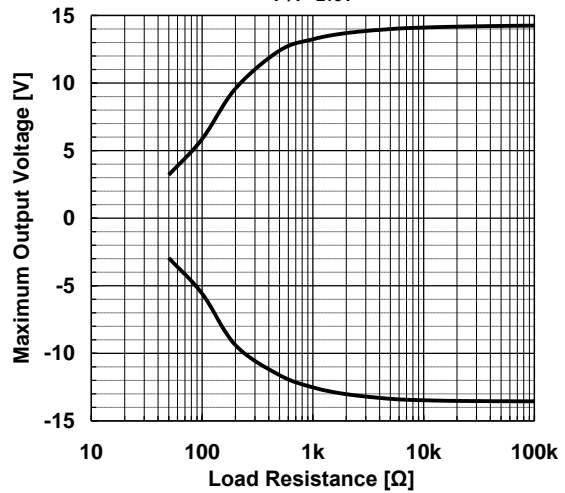

Voltage Noise vs. Frequency

$V^+/V^- = \pm 15V$, $G_V = 40dB$, $R_f = 2k\Omega$, $T_a = 25^\circ C$

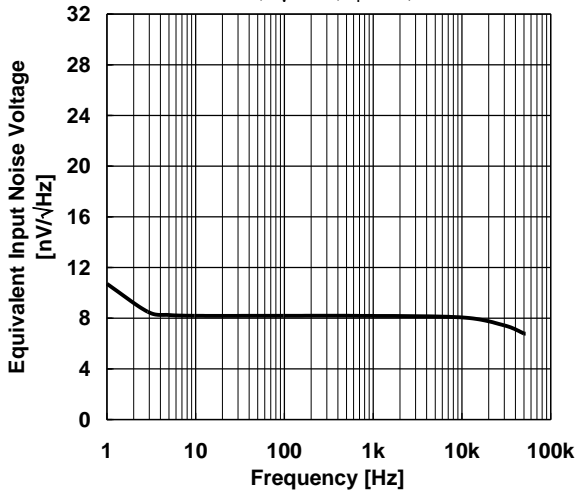

THD+N vs. Output Voltage

$V^+/V^- = \pm 15V$, $G_V = 20dB$, $R_G = 10k\Omega$, $R_S = 200\Omega$, $R_f = 2k\Omega$, $T_a = 25^\circ C$

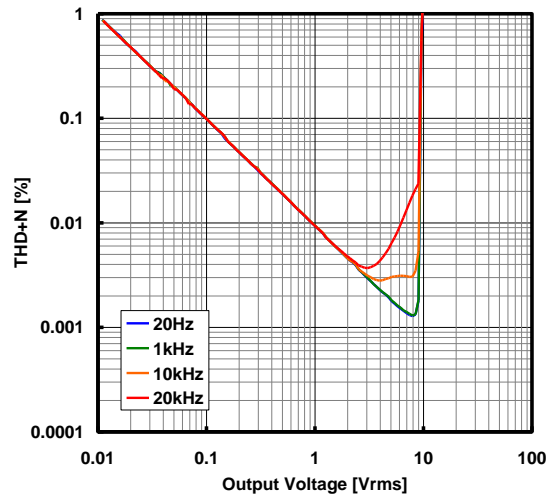

■ TYPICAL CHARACTERISTICS

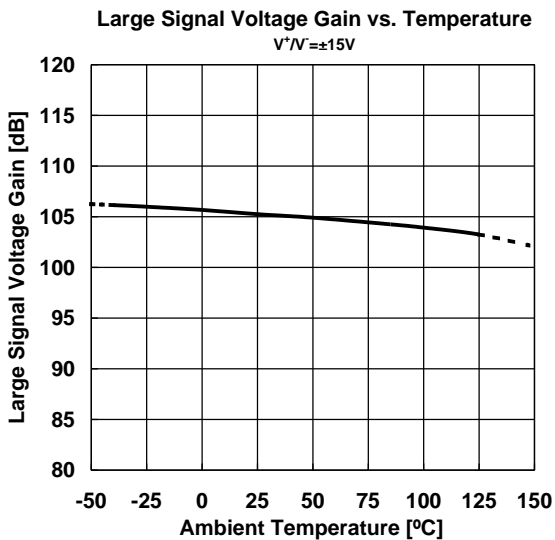
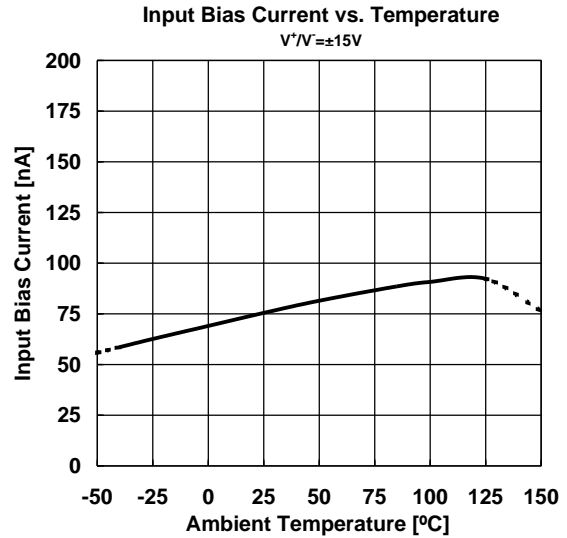
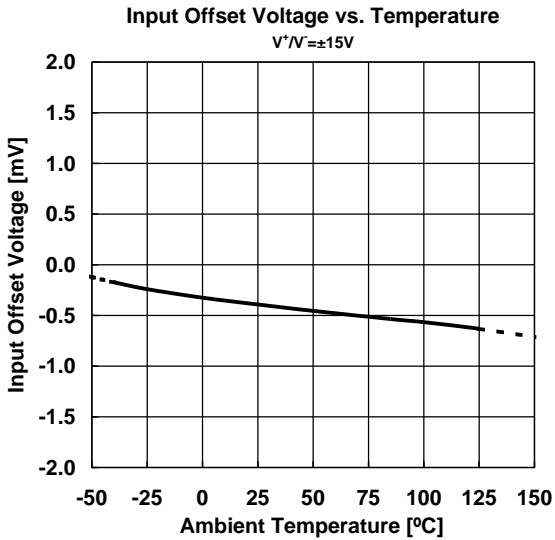
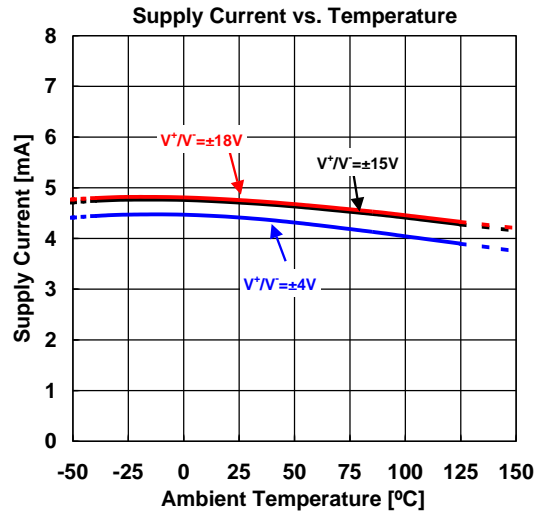
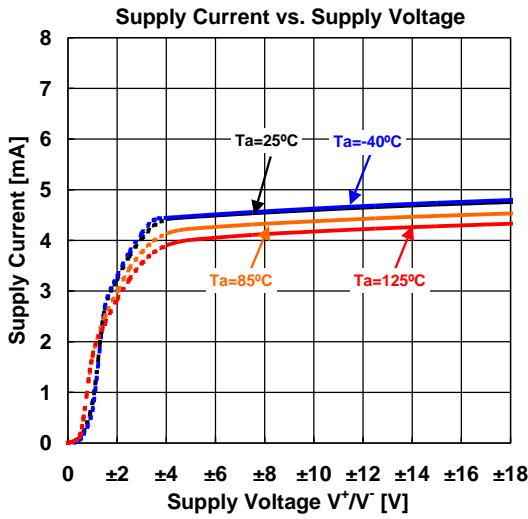

■ TYPICAL CHARACTERISTICS

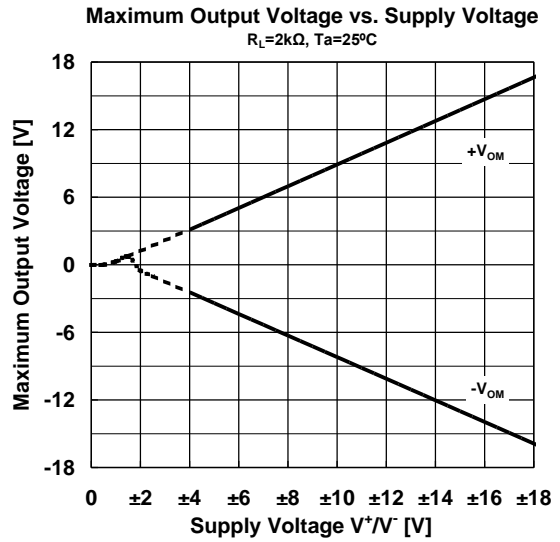
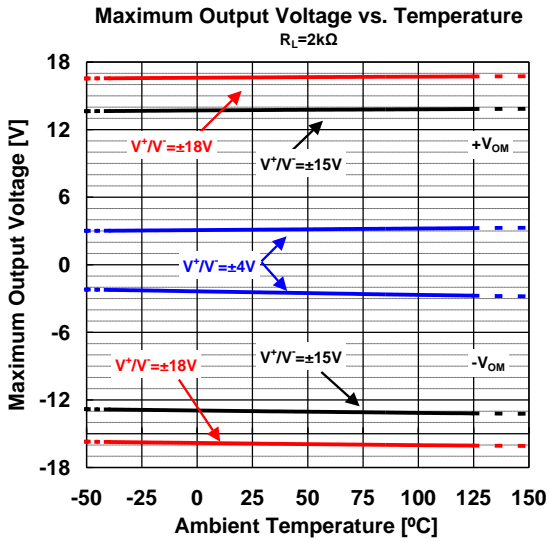
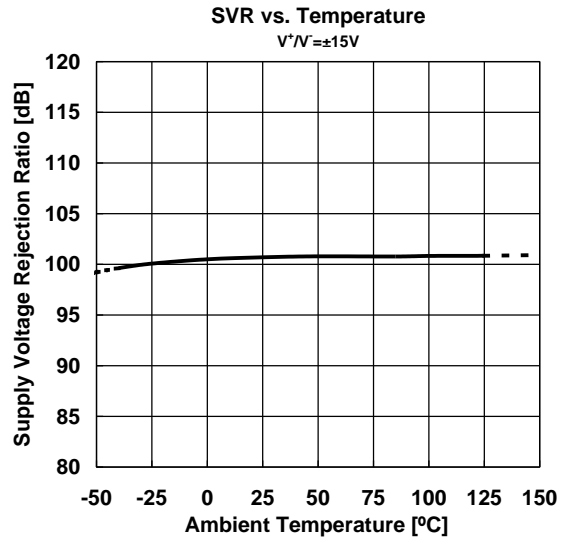
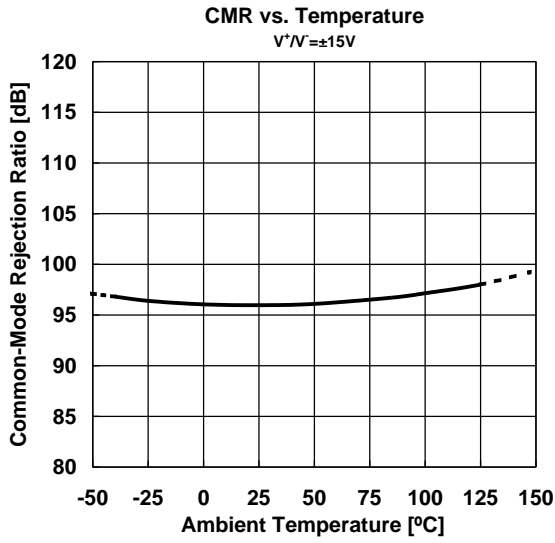

NJM8065

■PACKAGE OUTLINE UNIT : mm

SOP8

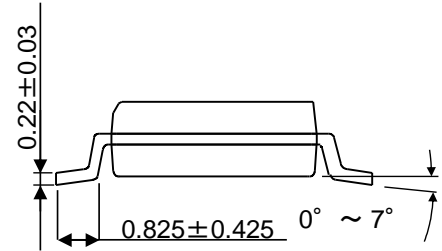
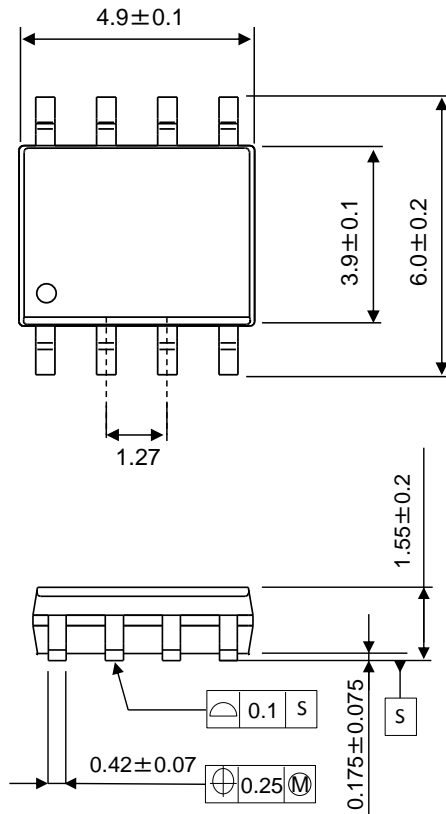

DMP8

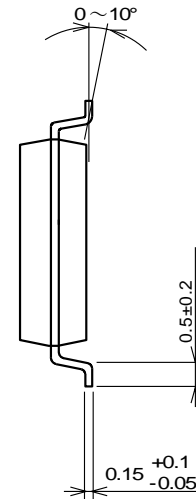
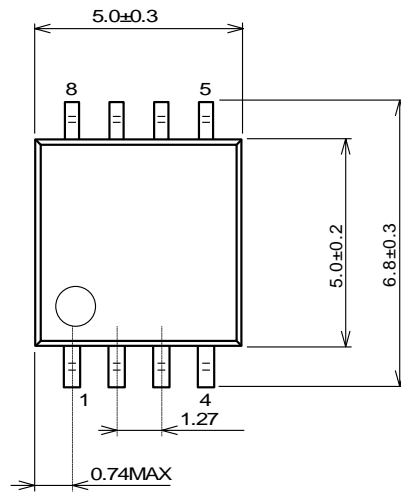

■PACKAGE OUTLINE UNIT : mm

MSOP8 (TVSP8)*

*MEET JEDEC MO-187-DA/ THIN TYPE

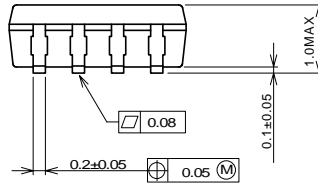
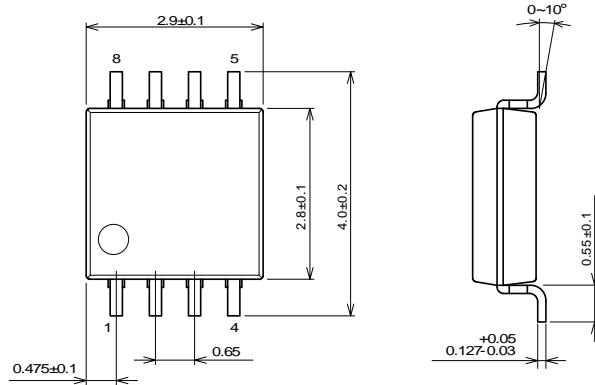

SSOP8

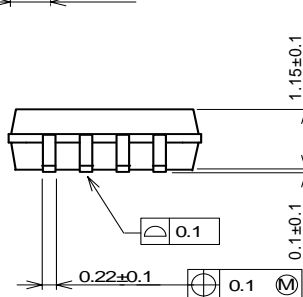
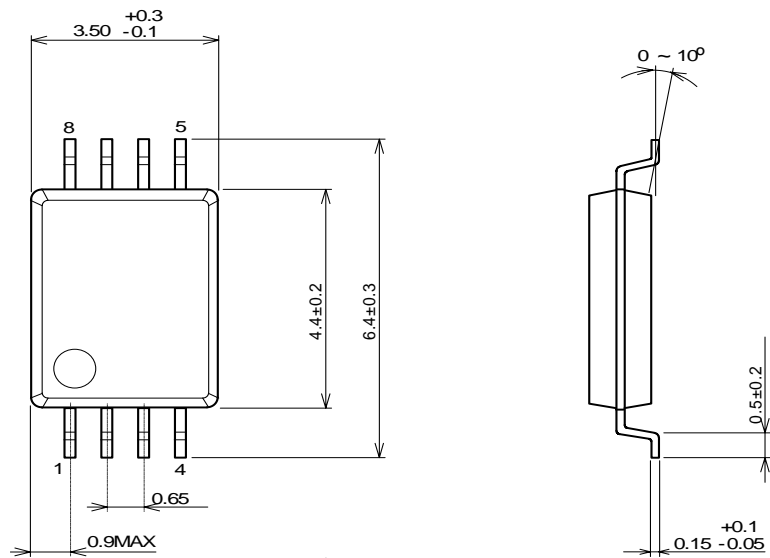

[CAUTION]

The specifications on this databook are only given for information, without any guarantee as regards either mistakes or omissions. The application circuits in this databook are described only to show representative usages of the product and not intended for the guarantee or permission of any right including the industrial rights.

Mouser Electronics

Authorized Distributor

Click to View Pricing, Inventory, Delivery & Lifecycle Information:

[NJR:](#)

[NJM8065G-TE2](#)



Компания «ЭлектроПласт» предлагает заключение долгосрочных отношений при поставках импортных электронных компонентов на взаимовыгодных условиях!

Наши преимущества:

- Оперативные поставки широкого спектра электронных компонентов отечественного и импортного производства напрямую от производителей и с крупнейших мировых складов;
- Поставка более 17-ти миллионов наименований электронных компонентов;
- Поставка сложных, дефицитных, либо снятых с производства позиций;
- Оперативные сроки поставки под заказ (от 5 рабочих дней);
- Экспресс доставка в любую точку России;
- Техническая поддержка проекта, помощь в подборе аналогов, поставка прототипов;
- Система менеджмента качества сертифицирована по Международному стандарту ISO 9001;
- Лицензия ФСБ на осуществление работ с использованием сведений, составляющих государственную тайну;
- Поставка специализированных компонентов (Xilinx, Altera, Analog Devices, Intersil, Interpoint, Microsemi, Aeroflex, Peregrine, Syfer, Eurofarad, Texas Instrument, Miteq, Cobham, E2V, MA-COM, Hittite, Mini-Circuits, General Dynamics и др.);

Помимо этого, одним из направлений компании «ЭлектроПласт» является направление «Источники питания». Мы предлагаем Вам помощь Конструкторского отдела:

- Подбор оптимального решения, техническое обоснование при выборе компонента;
- Подбор аналогов;
- Консультации по применению компонента;
- Поставка образцов и прототипов;
- Техническая поддержка проекта;
- Защита от снятия компонента с производства.



Как с нами связаться

Телефон: 8 (812) 309 58 32 (многоканальный)

Факс: 8 (812) 320-02-42

Электронная почта: org@eplast1.ru

Адрес: 198099, г. Санкт-Петербург, ул. Калинина, дом 2, корпус 4, литера А.