

## Solid-state Relay

## G3CN

### Low-cost, PCB-mounting SSR for FA Equipment Requiring High Reliability

- Wide I/O voltage range: 3 to 28 VDC input and 75 to 264 VAC or 3 to 28 VDC input and 3 to 52.8 VDC output.
- Two load currents available: 2 A and 3 A
- Flat and vertical models available for a variety of applications.

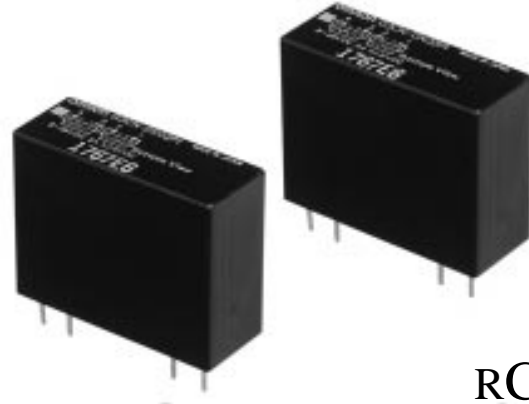

RC

### Ordering Information

Isolation	Zero cross function	Indicator	Applicable output load	Rated input voltage	Model
Phototriac	Yes	No	2 A at 75 to 264 VAC	4 to 24 VDC	G3CN-202P-US
			3 A at 75 to 264 VAC		G3CN-202P1-US*
					G3CN-203P-US
					G3CN-203P1-US*
Phototriac	No		2 A at 75 to 264 VAC	5, 12, 24 VDC	G3CN-202PL-US
			3 A at 75 to 264 VAC		G3CN-202PL1-US*
					G3CN-203PL-US
					G3CN-203PL1-US*
Photocoupler	---		2 A at 3 to 52.8 VDC	4 to 24 VDC	G3CN-DX02P-US
			3 A at 3 to 52.8 VDC		G3CN-DX02P1-US*
					G3CN-DX03P-US
					G3CN-DX03P1-US*

\*Vertical models.

### Specifications

#### ■ Ratings Input

Model	Rated voltage	Operating voltage	Impedance	Voltage level	
				Must operate voltage	Must release voltage
G3CN-202P(1) G3CN-203P(1)	4 to 24 VDC	3 to 28 VDC	1.5 kW <sup>+20%</sup> / <sub>-10%</sub>	3 VDC max.	1 VDC min.
G3CN-202PL(1)	5 VDC	4 to 6 VDC	390 W <sup>+20%</sup>	4 VDC max.	
G3CN-203PL(1)	12 VDC	9.6 to 14.4 VDC	900 W <sup>+20%</sup>	9.6 VDC max.	
	24 VDC	19.2 to 28.8 VDC	2 kW <sup>+20%</sup>	19.2 VDC max.	
G3CN-DX02P(1) G3CN-DX03P(1)	4 to 24 VDC	3 to 28 VDC	1.5 kW <sup>+20%</sup> / <sub>-10%</sub>	3 VDC max.	

**Note:** The input impedance is measured at the maximum value of the rated supply voltage. For example, with the model rated at 4 to 24 VDC, the input impedance is measured at 24 VDC.

## Output

Model	Applicable load		
	Rated load voltage	Load current	Inrush current
		Without heat sink	
G3CN-202P(1) G3CN-202PL(1)	75 to 264 VAC	0.1 to 2 A	30 A (60 Hz, 1 cycle)
G3CN-203P(1) G3CN-203PL(1)		0.1 to 3 A	45 A (60 Hz, 1 cycle)
G3CN-DX02P(1)	3 to 52.8 VDC	0.1 to 2 A	12 A (10 ms)
G3CN-DX03P(1)		0.1 to 3 A	18 A (10 ms)

## ■ Characteristics

Item	G3CN-202P(1)/203P(1)	G3CN-202PL(1)/203PL(1)	G3CN-DX02P(1)/03P(1)
Operate time	1/2 of load power source cycle + 1 ms max.	1 ms max.	0.5 ms max.
Release time	1/2 of load power source cycle + 1 ms max.	1/2 of load power source cycle + 1 ms max.	2 ms max.
Output ON voltage drop	1.6 V (RMS) max.		1.5 V max.
Leakage current	5 mA max. (at 100 VAC) 10 mA max. (at 200 VAC)	2.5 mA max. (at 100 VAC) 5 mA max. (at 200 VAC)	5 mA max. (at 50 VDC)
Insulation resistance	100 MW min. (at 500 VDC)		
Dielectric strength	2,500 VAC, 50/60 Hz for 1 min		
Vibration resistance	Malfunction: 10 to 55 Hz, 1.5-mm double amplitude		
Shock resistance	Malfunction: 1,000 m/s <sup>2</sup> (approx. 100G)		
Ambient temperature	Operating: -30% to 80°C (with no icing) Storage: -30% to 100°C (with no icing)		
Ambient humidity	Operating: 45% to 85%		
Weight	Approx. 25 g		

## ■ Approved Standards

UL114 File No.E64562/CSA C22.2 (No.0, No.14) File No. LR35535

Model	Ratings
G3CN-202P(L)(1)-US	2 A at 240 VAC
G3CN-203P(L)(1)-US	3 A at 240 VAC
G3CN-DX02P(1)-US	2 A at 48 VDC
G3CN-DX03P(1)-US	3 A at 48 VDC

## Engineering Data

## Load Current vs. Ambient Temperature Characteristics

G3CN-202P(1)/-202PL(1)/-DX02P(1)

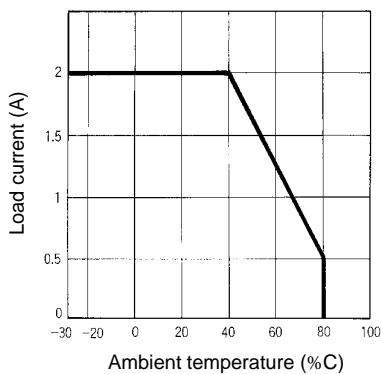

G3CN-203P(1)/-203PL(1)/-DX03P(1)



**Inrush Current Resistivity**

**2-A Load**

Non-repetitive (Keep the inrush current to half the rated value if it occurs repetitively.)

**G3CN-202P(1)/-202PL(1)**

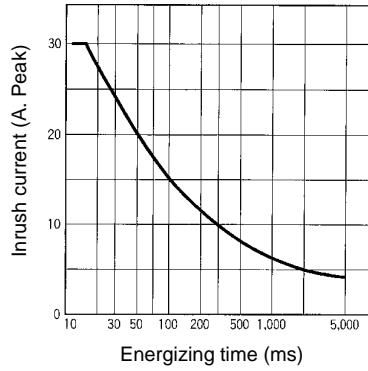

**G3CN-DX02P(1)**

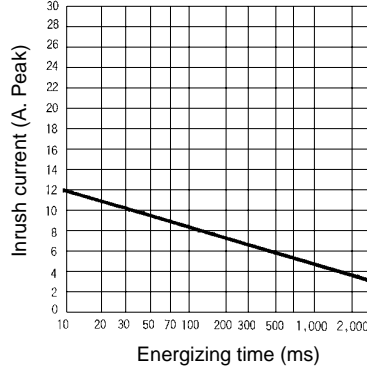

**3-A Load**

**G3CN-203P(1)/-203PL(1)**

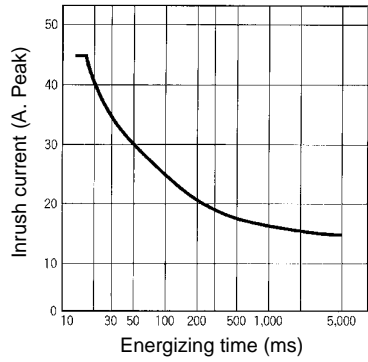

**G3CN-DX03P(1)**

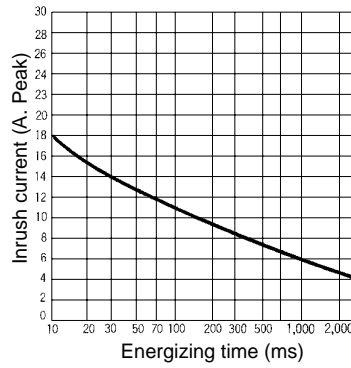

# Dimensions

**Note:** All units are in millimeters unless otherwise indicated.

## Flat Model

G3CN-20\_P/-20\_PL/-DX0\_P

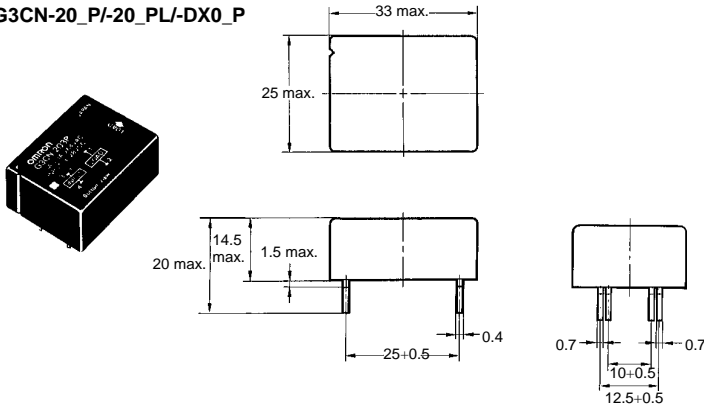

### Terminal Arrangement/ Mounting Holes (Bottom View)

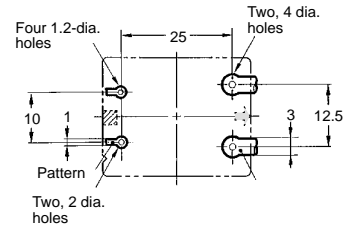

### Terminal Arrangement/ Internal Connections (Bottom View)

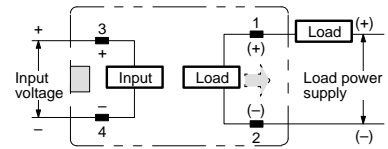

**Note:** Values in parentheses apply to the DC-load versions.

## Vertical Model

G3CN-20\_P1/-20\_PL1/-DX0\_P1

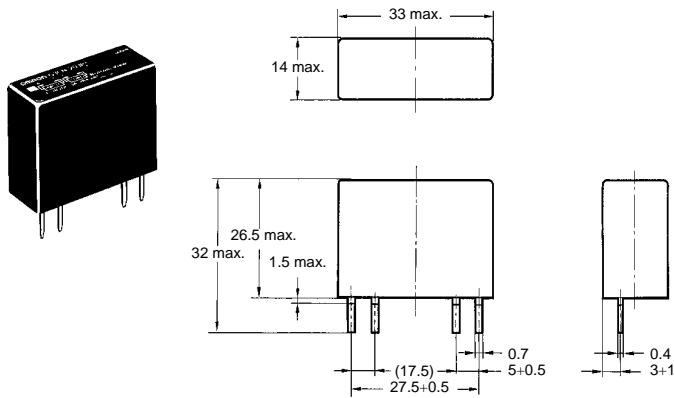

### Terminal Arrangement/ Mounting Holes (Bottom View)

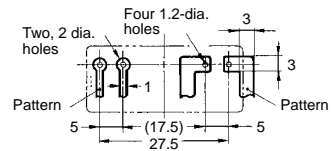

### Terminal Arrangement/ Internal Connections (Bottom View)

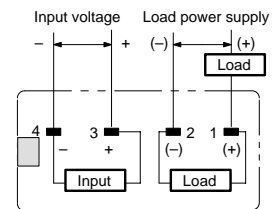

**Note:** Values in parentheses apply to the DC-load versions.

# Precautions

Refer to pages 5 to 13 for general precautions.

**ALL DIMENSIONS SHOWN ARE IN MILLIMETERS.**  
To convert millimeters into inches, multiply by 0.03937. To convert grams into ounces, multiply by 0.03527.



Компания «ЭлектроПласт» предлагает заключение долгосрочных отношений при поставках импортных электронных компонентов на взаимовыгодных условиях!

Наши преимущества:

- Оперативные поставки широкого спектра электронных компонентов отечественного и импортного производства напрямую от производителей и с крупнейших мировых складов;
- Поставка более 17-ти миллионов наименований электронных компонентов;
- Поставка сложных, дефицитных, либо снятых с производства позиций;
- Оперативные сроки поставки под заказ (от 5 рабочих дней);
- Экспресс доставка в любую точку России;
- Техническая поддержка проекта, помощь в подборе аналогов, поставка прототипов;
- Система менеджмента качества сертифицирована по Международному стандарту ISO 9001;
- Лицензия ФСБ на осуществление работ с использованием сведений, составляющих государственную тайну;
- Поставка специализированных компонентов (Xilinx, Altera, Analog Devices, Intersil, Interpoint, Microsemi, Aeroflex, Peregrine, Syfer, Eurofarad, Texas Instrument, Miteq, Cobham, E2V, MA-COM, Hittite, Mini-Circuits, General Dynamics и др.);

Помимо этого, одним из направлений компании «ЭлектроПласт» является направление «Источники питания». Мы предлагаем Вам помощь Конструкторского отдела:

- Подбор оптимального решения, техническое обоснование при выборе компонента;
- Подбор аналогов;
- Консультации по применению компонента;
- Поставка образцов и прототипов;
- Техническая поддержка проекта;
- Защита от снятия компонента с производства.



#### Как с нами связаться

**Телефон:** 8 (812) 309 58 32 (многоканальный)

**Факс:** 8 (812) 320-02-42

**Электронная почта:** [org@eplast1.ru](mailto:org@eplast1.ru)

**Адрес:** 198099, г. Санкт-Петербург, ул. Калинина, дом 2, корпус 4, литера А.