

Distinctive Characteristics

Various cap styles and colors to meet differing application needs.

Bright, full-face illumination to distinctively indicate status.

Rear panel threaded mounting or snap-in mounter for front panel mounting.

5-amp power rating standard. Dry circuit capability available.

Detent switching mechanism provides positive indication of actuation.

Heavy gauge steel case protects switch components and increases durability.

1,500V dielectric strength between contacts and case is accomplished by clinching the frame away from the terminals.

Solder lug and PC terminals staked into base.

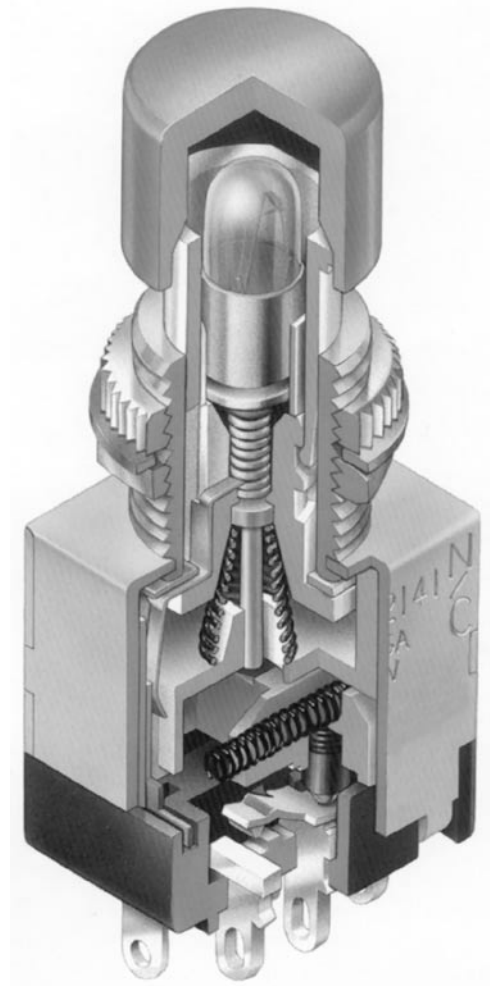

Actual Size

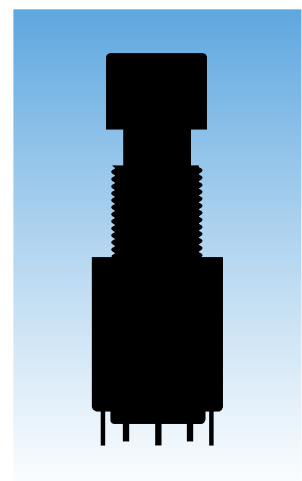

General Specifications

Electrical Capacity (Resistive Load)

Power Level (silver): 5A @ 125V AC & 3A @ 250V AC or 3A @ 30V DC
Logic or Power Level (gold over silver): 0.4VA maximum @ 28V AC/DC maximum or 5A @ 125V AC
 (Applicable Range 0.1mA ~ 0.1A @ 20mV ~ 28V)
 Note: See Supplement section to find explanation of dual rating & operating range.

Other Ratings

Contact Resistance: 10 milliohms maximum for silver; 20 milliohms maximum for gold
Insulation Resistance: 200 megohms minimum @ 500V DC
Dielectric Strength: 1,000V AC minimum between contacts for 1 minute minimum;
 1,500V AC minimum between contacts & case for 1 minute minimum
Mechanical Life: 30,000 operations minimum
Electrical Life: 10,000 operations minimum
Nominal Operating Force: 12.75N for momentary; 11.77N for alternate action
Travel: Pretravel: .039" (1.0mm); Overtravel: .157" (4.0mm); Total Travel: .196" (5.0mm)

Materials & Finishes

Plunger: Polyacetal resin
Bushing: Brass with nickel plating
Housing: Steel with chromate over zinc
Movable Contact: Silver
Stationary Contacts: Silver with silver plating or silver with gold plating
Base: Phenolic resin
Common Terminals: Copper with silver plating
End Terminals: Copper with silver plating or copper with gold plating
Lamp Terminals: Brass with nickel plating

Environmental Data

Operating Temperature Range: -10°C through +50°C (+14°F through +122°F) for spot illuminated
 -20°C through +50°C (-4°F through +122°F) for other illuminated
 -10°C through +50°C (+14°F through +122°F) for nonilluminated
Humidity: 90 ~ 95% humidity for 96 hours @ 40°C (104°F)
Vibration: 10 ~ 55Hz with peak-to-peak amplitude of 1.5mm traversing the frequency range
 & returning in 1 minute; 3 right angled directions for 2 hours
Shock: 50G (490m/s²) acceleration (tested in 6 right angled directions, with 5 shocks in each direction)

Installation

Cap Installation Force: 19.62N (4.41 lbf) maximum downward force on cap
Soldering Time & Temperature: 4 seconds maximum @ 410°C maximum

Standards & Certifications



UL & C-UL Recognition: All models recognized at 5A @ 125V AC;
 UL File No. WOYR2.E44145 & C-UL File No. WOYR8.E44145;
 add "/U" to end of part number to order UL mark on switch & add "/C-UL" to end of part
 number to order C-UL mark on switch (equivalent to CSA certification).

TYPICAL SWITCH ORDERING EXAMPLE

DLB **2141** **W** **01** — **L** **3** **G** —

POLES & CIRCUITS			
2141	DPDT	ON	(ON)
2145	DPDT	ON	ON

() = Momentary

TERMINALS	
01	Solder Lug
03	Straight PC

SNAP-IN MOUNTER	
No Code	No Mounter
S	Black Mounter for Square Caps
R	Black Mounter for Round Caps

CONTACT MATERIALS & RATINGS	
W	Silver Contacts 5A @ 125V AC
A	Gold over Silver Contacts 5A @ 125V AC & 0.4VA maximum @ 28V AC/DC maximum

LAMPS	
Incandescent & Neon	
E	6-volt
G	14-volt
L	28-volt
*N	110-volt Neon
0	No Lamp

* Neon recommended for cap codes 2 & 3 in white only.

CAP TYPES	
Solid Caps	
1	.748" (19.0mm) Square
2	.346" (8.8mm) Diameter Not for use with Mounter
3	.512" (13.0mm) Diameter Not for use with Mounter
Design Cap	
4	.748" (19.0mm) Diameter with Colored Lens

CAP OR LED COLORS	
Solid & Design Cap Colors	
B	White
C	Red
D	Amber
E	Yellow
F	Green
G	Blue

Note: Colors D & E are not available with Design Cap

LED used with Spot Illuminated	
D	Single Element

Spot Illuminated Caps	
6	.748" (19.0mm) Square
7	.748" (19.0mm) Diameter

LED Colors for Spot Illuminated	
C	Red
F	Green

DESCRIPTION FOR TYPICAL ORDERING EXAMPLE
DLB2141W01-L3G

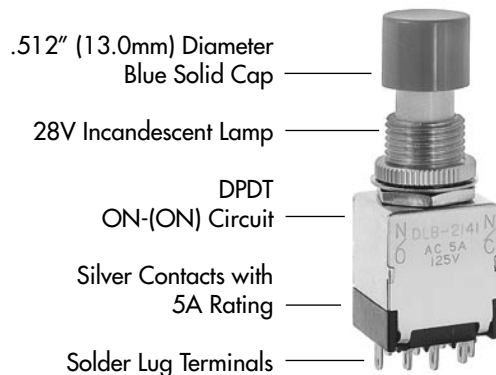

IMPORTANT:
Switches are supplied without UL & C-UL markings unless specified. Specific models & ratings noted on General Specifications page.

POLES & CIRCUITS

Pole	Model	Plunger Position () = Momentary		Connected Terminals		Throw & Power/Lamp Schematics
		Normal	Down	Normal	Down	
DP	DLB2141	ON	(ON)	2-3 5-6	2-1 5-4	Notes: Terminal numbers are not actually on the switch. Lamp circuit is isolated and requires an external power source. DPDT
	DLB2145	ON	ON			

CONTACT MATERIALS & RATINGS

W

Silver

Power Level

3A @ 125V AC & 250V AC

A

Gold over Silver

Power Level
or Logic Level

5A @ 125V AC
or 0.4VA maximum @ 28V AC/DC maximum

Note: This dual rated option is suitable when two or more identical switches are used in logic and in power circuits within the same application. See Supplement for complete explanation of dual rating and operating range.

TERMINALS

01

Solder Lug

Wiring for Solder Lug Terminals

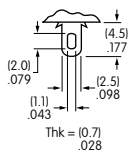

Switch terminal hole of .035" x .079" (0.9mm x 2.0mm) accommodates one solid 20-gauge wire or two solid or stranded 22-gauge wires.

Lamp terminal hole of .035" (0.9mm) diameter accommodates one solid 20-gauge wire.

03

Straight PC

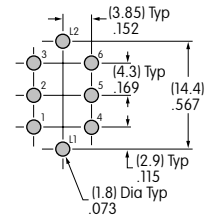
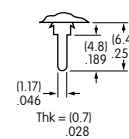

INCANDESCENT & NEON LAMP CODES & SPECIFICATIONS

Electrical specifications are determined at a basic temperature of 25°C.
Lamp circuit is independent of switch operation.
Incandescent & Neon lamps can be used with solid & design caps.

AT604 & AT604N	AT604 Incandescent 6-, 14-, or 28-volt; AT604N Neon 110-volt	E	G	L	* N	* Recommended Resistors: 33K ohms for 110V AC; 100K ohms for 220V AC	
<p>T-1 3/4 Midget Groove Base</p>	Voltage	V	6V AC	14V AC	28V AC		110V AC
	Current	I	200mA	80mA	40mA		1.5mA
	Endurance Average Hours		1,000	750	1,000		10,000
	Ambient Temperature Range		-20°C ~ +50°C				

0

No Lamp

Code 0 indicates that no lamp is used with the solid or design caps.

LED CODE & SPECIFICATIONS

Electrical specifications are determined at a basic temperature of 25°C. LED circuit is independent of switch operation. LEDs are colored in OFF state. For dimension drawings of lamps see Accessories and Hardware section.

If the source voltage is greater than rated voltage, a ballast resistor is required. The ballast resistor calculation and more lamp detail are shown in the Supplement section.

LED for Spot Illuminated Cap

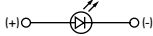
D Single Element LED LED is factory assembled in spot illuminated caps. 	Color Codes	C Red	F Green	
	Forward Peak Current	I_{FM}	35mA	30mA
	Continuous Forward Current	I_F	25mA	20mA
	Forward Voltage	V_F	1.65V	2.0V
	Reverse Peak Voltage	V_{RM}	3V	3V
	Current Reduction Rate Above 25°C	ΔI_F	0.57mA/°C	0.43mA/°C
	Ambient Temperature Range		-10°C ~ +50°C	

CAP TYPES & COLORS

1 Solid Cap AT419 .748" (19.0mm) Square

For use with Incandescent or Neon

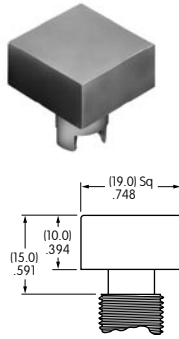

Colors Available:
B C D E F G

2 Solid Cap AT417 .346" (8.8mm) Diameter

For use with Incandescent or Neon

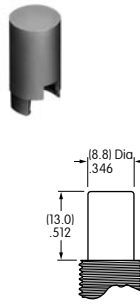

Colors Available:
B C D E F G

Not for use with snap-in mounter

3 Solid Cap AT418 .512" (13.0mm) Diameter

For use with Incandescent or Neon

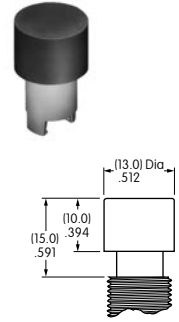

Colors Available:
B C D E F G

Not for use with snap-in mounter

4 Design Cap AT446 .748" (19.0mm) Diameter

Black Holder with Colored Lens

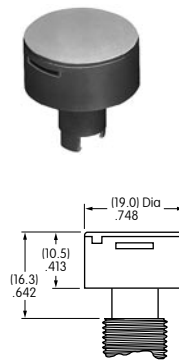

Lens Colors Available:
B C F G

6 Spot Illuminated AT463 .748" (19.0mm) Square

Black Cap with Clear Lens

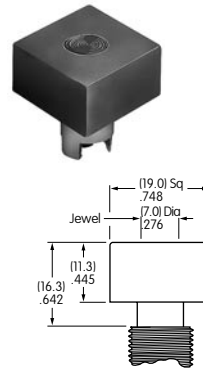

LED Colors:
C F

LED & Cap assembled at factory; not available separately

7 Spot Illuminated AT464 .748" (19.0mm) Diameter

Black Cap with Clear Lens

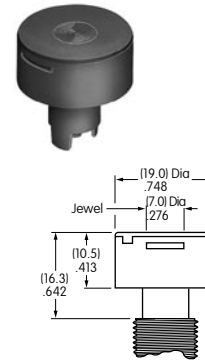

LED Colors:
C F

LED & Cap assembled at factory; not available separately

Material for all Caps: Polycarbonate Finish: Glossy

Color Codes: **B** White **C** Red **D** Amber **E** Yellow **F** Green **G** Blue

OPTIONAL SNAP-IN MOUNTERS

S AT517 Mounter for Square Caps AT419 & AT463

Glass fiber reinforced polyamide
Black only available (code A)

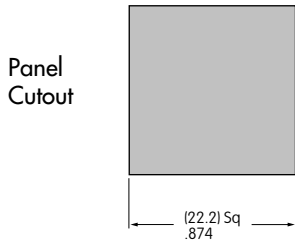

Recommended
Panel Thickness:
.039" ~ .157"
(1.0mm ~ 4.0mm)

The standard mounting hardware provided with the switch is used to assemble the square mounter.

R AT528 Mounter for Round Caps AT446 & AT464

Glass fiber reinforced polyamide
Black only available (code A)

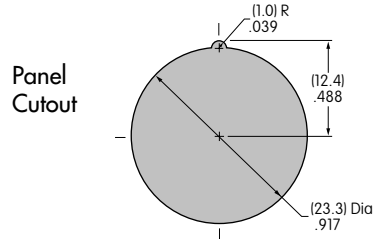

Recommended
Panel Thickness:
.039" ~ .157"
(1.0mm ~ 4.0mm)

Locking Ring AT506 and Hex Nut AT527 are provided with the round mounter. It is assembled to the switch with this hardware plus the lockwasher and hex nut provided as standard hardware. Not for use with Solid Caps AT417 and AT418.

TYPICAL SWITCH DIMENSIONS

Solder Lug • Bushing Mount

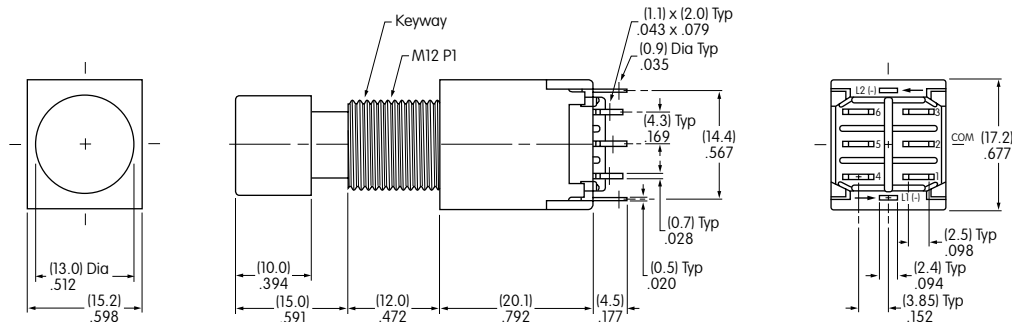

DLB2145W01-G3G

Solder Lug • Square Snap-in Mounter

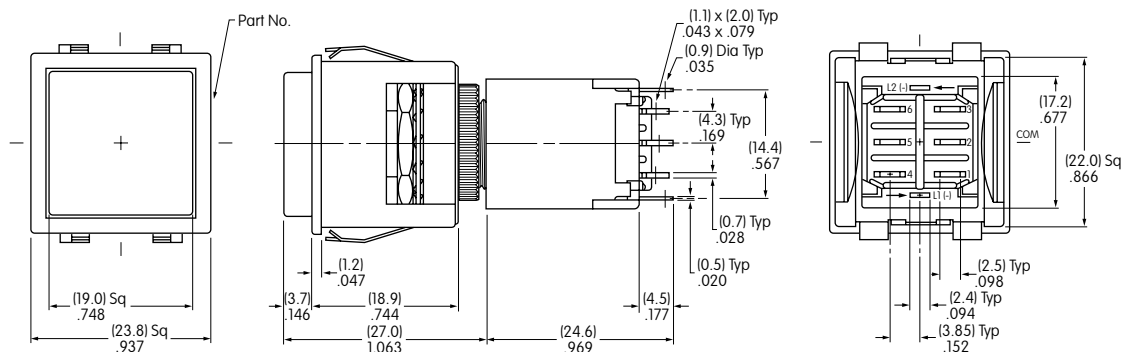
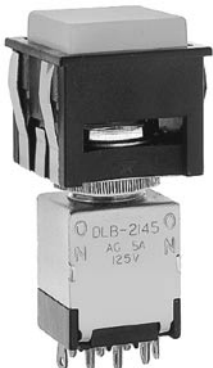

DLB2145W01-G1C-S

TYPICAL SWITCH DIMENSIONS

Solder Lug • Round Snap-in Mounter

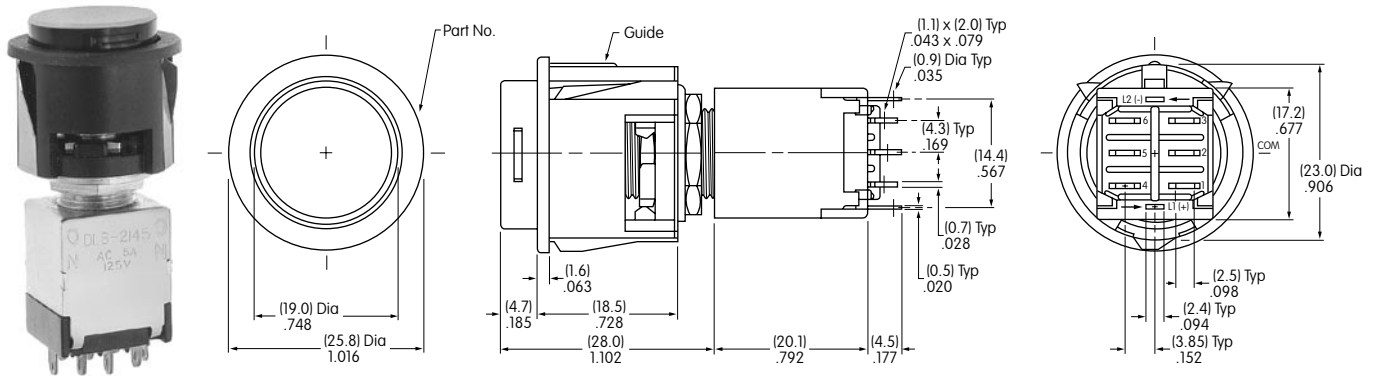

DLB2145W01-E4C-R

STANDARD HARDWARE

AT504M
Knurled Face Nut
Brass with Chrome Plating

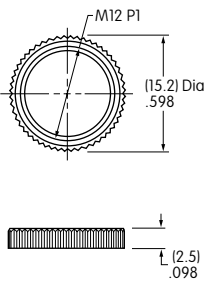

AT508
Lockwasher
Steel with Zinc Plating

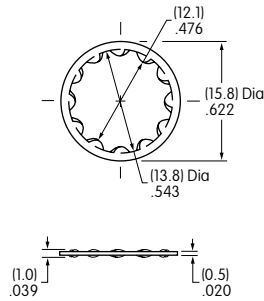

AT527M
Hex Nut
Steel with Nickel Plating

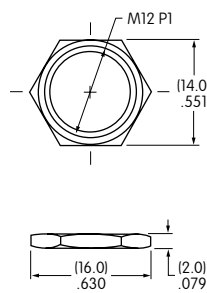

AT506
Locking Ring
Steel with Zinc Plating

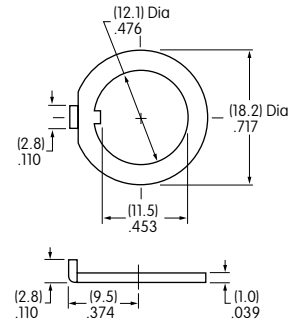

Maximum Effective Panel Thickness & Cutouts

With Standard Hardware

.220" (5.6mm)

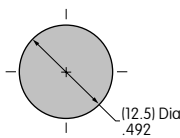

With Standard Hardware & Keyway

.220" (5.6mm)

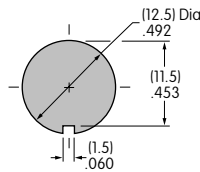

With Standard Hardware & Locking Ring

.181" (4.6mm)

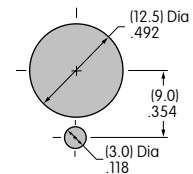

LEGENDS

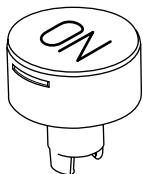

Inscriptions can be placed on solid and design caps. Details regarding screen printing or engraving may be obtained from the factory.



Компания «ЭлектроПласт» предлагает заключение долгосрочных отношений при поставках импортных электронных компонентов на взаимовыгодных условиях!

Наши преимущества:

- Оперативные поставки широкого спектра электронных компонентов отечественного и импортного производства напрямую от производителей и с крупнейших мировых складов;
- Поставка более 17-ти миллионов наименований электронных компонентов;
- Поставка сложных, дефицитных, либо снятых с производства позиций;
- Оперативные сроки поставки под заказ (от 5 рабочих дней);
- Экспресс доставка в любую точку России;
- Техническая поддержка проекта, помощь в подборе аналогов, поставка прототипов;
- Система менеджмента качества сертифицирована по Международному стандарту ISO 9001;
- Лицензия ФСБ на осуществление работ с использованием сведений, составляющих государственную тайну;
- Поставка специализированных компонентов (Xilinx, Altera, Analog Devices, Intersil, Interpoint, Microsemi, Aeroflex, Peregrine, Syfer, Eurofarad, Texas Instrument, Miteq, Cobham, E2V, MA-COM, Hittite, Mini-Circuits, General Dynamics и др.);

Помимо этого, одним из направлений компании «ЭлектроПласт» является направление «Источники питания». Мы предлагаем Вам помощь Конструкторского отдела:

- Подбор оптимального решения, техническое обоснование при выборе компонента;
- Подбор аналогов;
- Консультации по применению компонента;
- Поставка образцов и прототипов;
- Техническая поддержка проекта;
- Защита от снятия компонента с производства.



Как с нами связаться

Телефон: 8 (812) 309 58 32 (многоканальный)

Факс: 8 (812) 320-02-42

Электронная почта: org@eplast1.ru

Адрес: 198099, г. Санкт-Петербург, ул. Калинина, дом 2, корпус 4, литера А.