

FEATURES

- Low offset voltage: 130 μV max**
- Input offset drift: 1.5 $\mu\text{V}/^\circ\text{C}$ max**
- Low noise: 0.25 μV p-p**
- High gain, CMRR and PSRR: 115 dB min**
- Low supply current: 1.1 mA**
- Wide supply voltage range: $\pm 4\text{ V}$ to $\pm 18\text{ V}$ operation**

APPLICATIONS

- Medical and industrial instrumentation**
- Sensors and controls**
 - Thermocouple**
 - RTDs**
 - Strain bridges**
 - Shunt current measurements**
- Precision filters**

GENERAL DESCRIPTION

The AD8677 is the next generation of precision, ultralow offset amplifiers. It builds on the high performance of the OP07 and integrates lower power (1.1 mA typical), lower input bias current ($\pm 1\text{ nA}$ maximum), and higher CMRR/PSRR (130 dB) in the small TSOT package. Operation is fully specified from $\pm 5\text{ V}$ to $\pm 15\text{ V}$ supply.

The AD8677 provides higher accuracy than industry-standard OP07-type amplifiers due to Analog Devices' iPolar™ process, which supports enhanced performance in a smaller footprint. These performance enhancements include wider output swing, lower power, and higher CMRR (common-mode rejection ratio) and PSRR (power supply rejection ratio). The AD8677 maintains stability of offsets and gain virtually regardless of variations in time or temperature. Excellent linearity and gain accuracy can be maintained at high closed-loop gains.

The AD8677 is fully specified over the extended industrial temperature range of -40°C to $+125^\circ\text{C}$. The AD8677 amplifier is available in the tiny, 5-lead TSOT and the popular 8-lead, narrow SOIC lead-free packages.

PIN CONFIGURATIONS

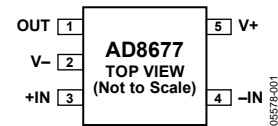

Figure 1. 5-Lead TSOT (UJ-5)

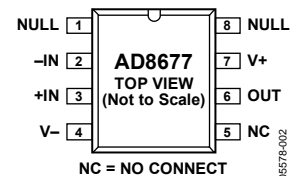

Figure 2. 8-Lead SOIC_N (R-8)

Rev. A

Information furnished by Analog Devices is believed to be accurate and reliable. However, no responsibility is assumed by Analog Devices for its use, nor for any infringements of patents or other rights of third parties that may result from its use. Specifications subject to change without notice. No license is granted by implication or otherwise under any patent or patent rights of Analog Devices. Trademarks and registered trademarks are the property of their respective owners.

TABLE OF CONTENTS

Features	1	Absolute Maximum Ratings	5
Applications.....	1	Thermal Resistance	5
General Description	1	ESD Caution.....	5
Pin Configurations	1	Typical Performance Characteristics	6
Revision History	2	Outline Dimensions	13
Specifications.....	3	Ordering Guide	13

REVISION HISTORY

6/11—Rev. 0 to Rev. A

Change to Figure 43	12
Updated Outline Dimensions	13

11/05—Revision 0: Initial Version

SPECIFICATIONS

$V_S = \pm 5.0\text{ V}$, $T_A = +25^\circ\text{C}$, unless otherwise specified.

Table 1.

Parameter	Symbol	Test Conditions/Comments	Min	Typ	Max	Unit
INPUT CHARACTERISTICS						
Offset Voltage	V_{OS}	$-40^\circ\text{C} \leq T_A \leq +125^\circ\text{C}$		40	130	μV
Input Bias Current	I_B	$-40^\circ\text{C} \leq T_A \leq +125^\circ\text{C}$		0.2	1	nA
Input Offset Current	I_{OS}	$-40^\circ\text{C} \leq T_A \leq +125^\circ\text{C}$		0.1	1	nA
Input Voltage Range		$-40^\circ\text{C} \leq T_A \leq +125^\circ\text{C}$	-3.5		+3.5	V
Common-Mode Rejection Ratio	CMRR	$V_{CM} = \pm 3\text{ V}$ $-40^\circ\text{C} \leq T_A \leq +125^\circ\text{C}$	120	127		dB
Open-Loop Gain	A_{VO}	$R_L = 2\text{ k}\Omega$ to ground, $V_O = \pm 3\text{ V}$ $-40^\circ\text{C} \leq T_A \leq +125^\circ\text{C}$	1000	10000		V/mV
	$\Delta V_{OS}/\Delta T$	$-40^\circ\text{C} \leq T_A \leq +125^\circ\text{C}$		0.5	1.4	$\mu\text{V}/^\circ\text{C}$
OUTPUT CHARACTERISTICS						
Output Voltage Swing	V_{OUT}	$R_L = 10\text{ k}\Omega$ to ground $-40^\circ\text{C} \leq T_A \leq +125^\circ\text{C}$	± 3.95	± 4.1		V
		$R_L = 2\text{ k}\Omega$ to ground $-40^\circ\text{C} \leq T_A \leq +125^\circ\text{C}$	± 3.95			V
		$R_L = 2\text{ k}\Omega$ to ground $-40^\circ\text{C} \leq T_A \leq +125^\circ\text{C}$	± 3.9	± 4		V
Short-Circuit Limit Output Current	I_{SC}		± 3.9			V
	I_O	$V_O = 3.5\text{ V}$		27		mA
				15		mA
POWER SUPPLY						
Power Supply Rejection Ratio	PSRR	$V_S = \pm 4.0\text{ V}$ to $\pm 18.0\text{ V}$ $-40^\circ\text{C} \leq T_A \leq +125^\circ\text{C}$	115	130		dB
Supply Current/Amplifier	I_{SY}	$V_O = 0\text{ V}$ $-40^\circ\text{C} \leq T_A \leq +125^\circ\text{C}$		1.1	1.25	mA
					1.7	mA
DYNAMIC PERFORMANCE						
Slew Rate	SR	$R_L = 10\text{ k}\Omega$		0.2		V/ μs
Gain Bandwidth Product	GBP			0.6		MHz
Phase Margin				80		Degrees
NOISE PERFORMANCE						
Voltage Noise	$e_{n,p-p}$	0.1 Hz to 10 Hz		0.28		$\mu\text{V p-p}$
Voltage Noise Density	e_n	$f = 1\text{ kHz}$		10		nV/ $\sqrt{\text{Hz}}$
Current Noise Density	i_n	$f = 1\text{ kHz}$		0.074		pA/ $\sqrt{\text{Hz}}$

AD8677

$V_S = \pm 15\text{ V}$, $T_A = +25^\circ\text{C}$, unless otherwise specified.

Table 2.

Parameter	Symbol	Test Conditions/Comments	Min	Typ	Max	Unit
INPUT CHARACTERISTICS						
Offset Voltage	V_{OS}	$-40^\circ\text{C} \leq T_A \leq +125^\circ\text{C}$		45	130	μV
					350	μV
Input Bias Current	I_B	$-40^\circ\text{C} \leq T_A \leq +125^\circ\text{C}$		0.2	1	nA
Input Offset Current	I_{OS}	$-40^\circ\text{C} \leq T_A \leq +125^\circ\text{C}$		0.2	1	nA
					1	nA
Input Voltage Range			-13.5		+13.5	V
Common-Mode Rejection Ratio	CMRR	$V_{CM} = \pm 13.0\text{ V}$ $-40^\circ\text{C} \leq T_A \leq +125^\circ\text{C}$	120	140		dB
Open Loop Gain	A_{VO}	$R_L = 2\text{ k}\Omega$ to ground, $V_O = \pm 11\text{ V}$ $-40^\circ\text{C} \leq T_A \leq +125^\circ\text{C}$	1000	10000		V/mV
Offset Voltage Drift	$\Delta V_{OS}/\Delta T$	$-40^\circ\text{C} \leq T_A \leq +125^\circ\text{C}$		0.5	1.5	$\mu\text{V}/^\circ\text{C}$
OUTPUT CHARACTERISTICS						
Output Voltage Swing	V_{OUT}	$R_L = 10\text{ k}\Omega$ to ground $-40^\circ\text{C} \leq T_A \leq +125^\circ\text{C}$	± 13.95	14		V
			± 13.9			V
		$R_L = 2\text{ k}\Omega$ to ground $-40^\circ\text{C} \leq T_A \leq +125^\circ\text{C}$	± 13.75	13.8		V
			± 13.7			V
Short Circuit Limit	I_{SC}			30		mA
Output Current	I_O	$V_O = 13.5\text{ V}$		15		mA
POWER SUPPLY						
Power Supply Rejection Ratio	PSRR	$V_S = \pm 4.0\text{ V}$ to $\pm 18.0\text{ V}$ $-40^\circ\text{C} \leq T_A \leq +125^\circ\text{C}$	115	130		dB
			110			dB
Supply Current/Amplifier	I_{SY}	$V_O = 0\text{ V}$ $-40^\circ\text{C} \leq T_A \leq +125^\circ\text{C}$		1.1	1.3	mA
					1.8	mA
DYNAMIC PERFORMANCE						
Slew Rate	SR	$R_L = 10\text{ k}\Omega$		0.2		V/ μs
Gain Bandwidth Product	GBP			0.6		MHz
Phase Margin				80		Degrees
NOISE PERFORMANCE						
Voltage Noise	$e_{n\text{ p-p}}$	0.1 Hz to 10 Hz		0.25		$\mu\text{V p-p}$
Voltage Noise Density	e_n	$f = 1\text{ kHz}$		10		nV/ $\sqrt{\text{Hz}}$
Current Noise Density	i_n	$f = 1\text{ kHz}$		0.074		pA/ $\sqrt{\text{Hz}}$

ABSOLUTE MAXIMUM RATINGS

Table 3.

Parameter	Value
Supply Voltage	± 18 V
Input Voltage	$\pm V$ Supply
Differential Input Voltage	± 0.7 V
Output Short-Circuit Duration to GND	Indefinite
Storage Temperature Range	
UJ-5, R Package	-65°C to $+150^{\circ}\text{C}$
Operating Temperature Range	-40°C to $+125^{\circ}\text{C}$
Junction Temperature Range	
RM, R Package	-65°C to $+150^{\circ}\text{C}$
Lead Temperature (Soldering, 10 sec)	$+300^{\circ}\text{C}$

Stresses above those listed under Absolute Maximum Ratings may cause permanent damage to the device. This is a stress rating only; functional operation of the device at these or any other conditions above those indicated in the operational section of this specification is not implied. Exposure to absolute maximum rating conditions for extended periods may affect device reliability.

THERMAL RESISTANCE

θ_{JA} is specified for the worst-case conditions, that is, a device soldered in a circuit board for surface-mount packages.

Table 4.

Package Type	θ_{JA}	θ_{JC}	Unit
5-Lead TSOT (UJ-5)	207	61	$^{\circ}\text{C}/\text{W}$
8-Lead SOIC (R-8)	158	43	$^{\circ}\text{C}/\text{W}$

ESD CAUTION

ESD (electrostatic discharge) sensitive device. Electrostatic charges as high as 4000 V readily accumulate on the human body and test equipment and can discharge without detection. Although this product features proprietary ESD protection circuitry, permanent damage may occur on devices subjected to high energy electrostatic discharges. Therefore, proper ESD precautions are recommended to avoid performance degradation or loss of functionality.



TYPICAL PERFORMANCE CHARACTERISTICS

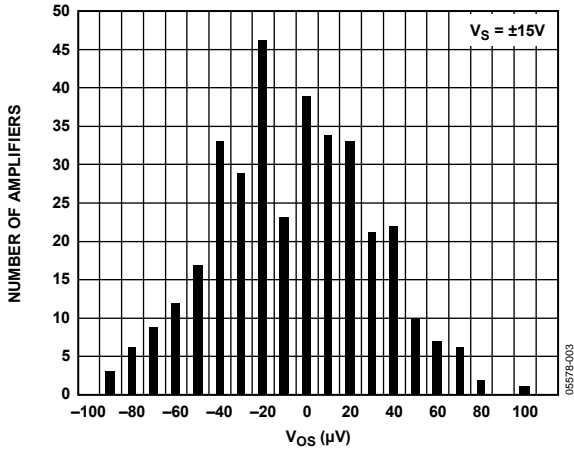

Figure 3. Input Offset Voltage Distribution

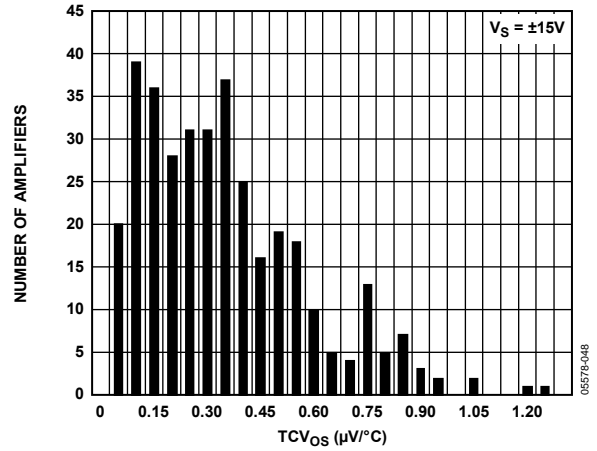

Figure 6. TCVos vs. Number of Amplifiers

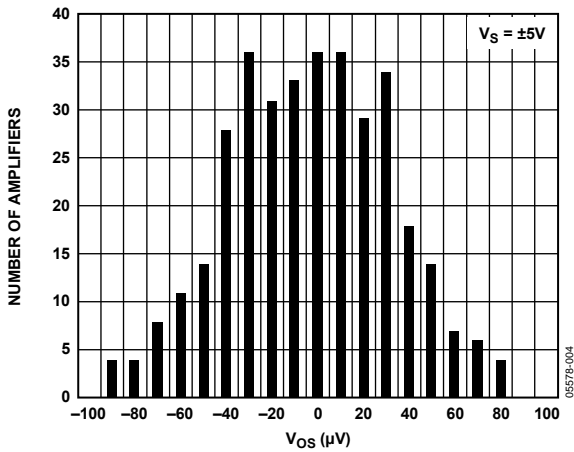

Figure 4. Input Offset Voltage Distribution

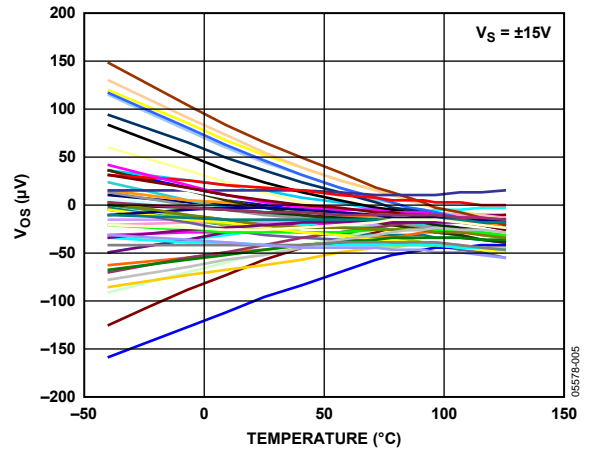

Figure 7. Offset Voltage vs. Temperature

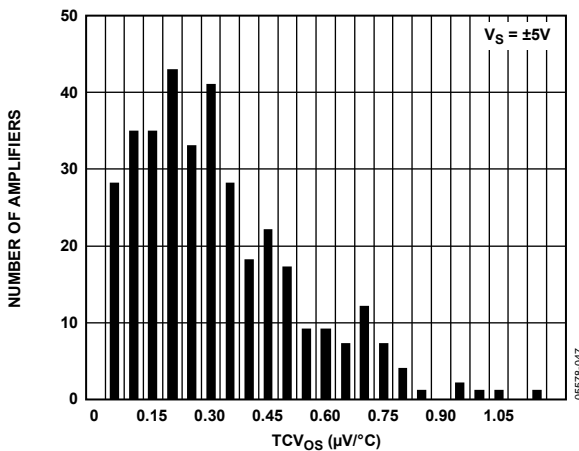

Figure 5. TCVos vs. Number of Amplifiers

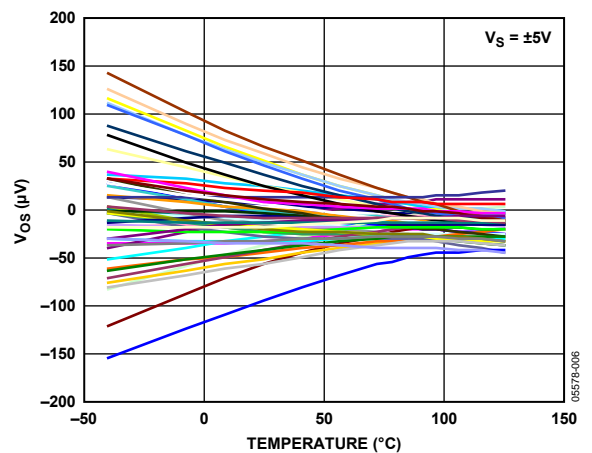

Figure 8. Offset Voltage vs. Temperature

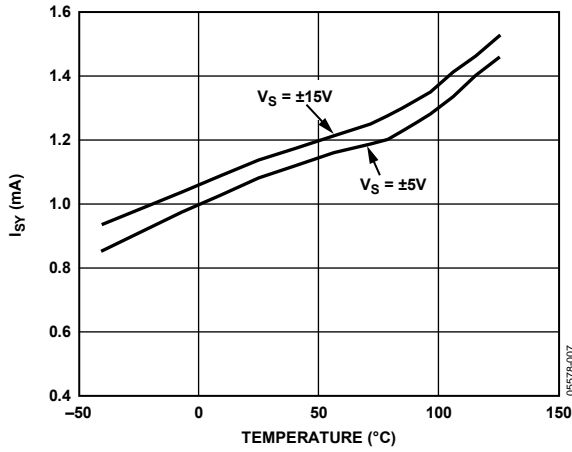

Figure 9. Supply Current vs. Temperature

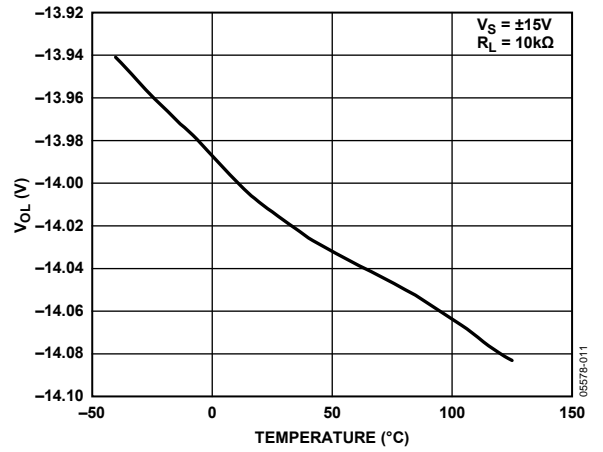

Figure 12. $-V_{OUT}$ vs. Temperature

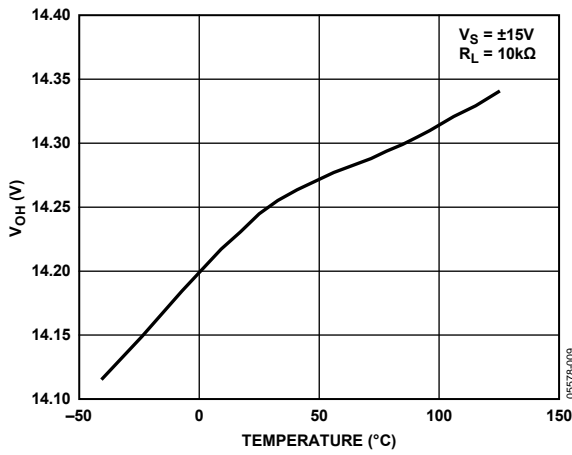

Figure 10. $+V_{OUT}$ vs. Temperature

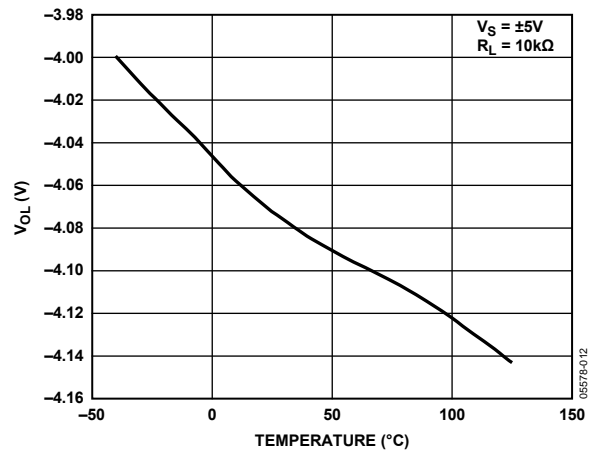

Figure 13. $-V_{OUT}$ vs. Temperature

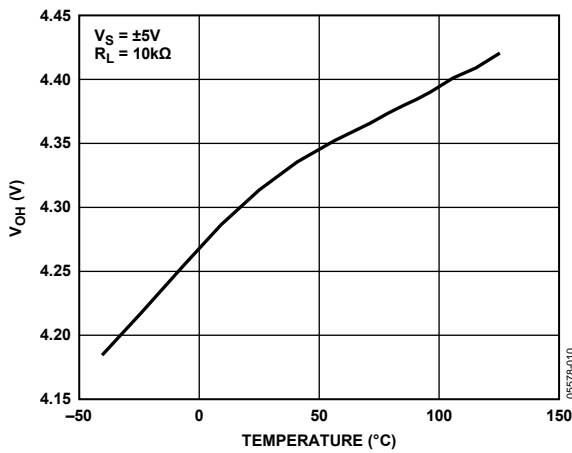

Figure 11. $+V_{OUT}$ vs. Temperature

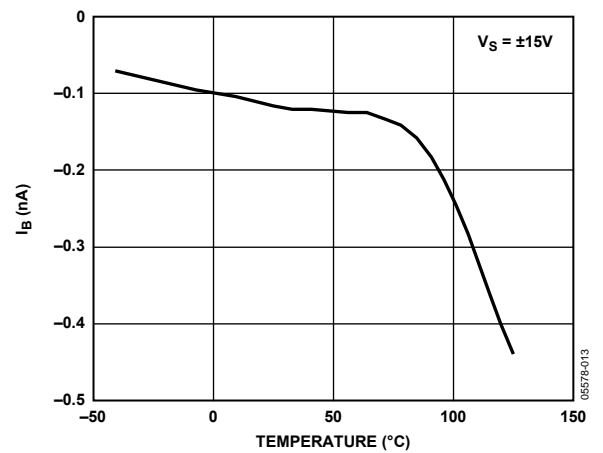

Figure 14. Input Bias Current vs. Temperature

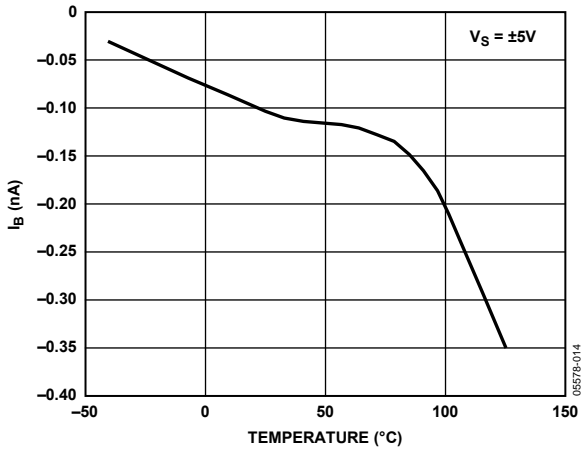

Figure 15. Input Bias Current vs. Temperature

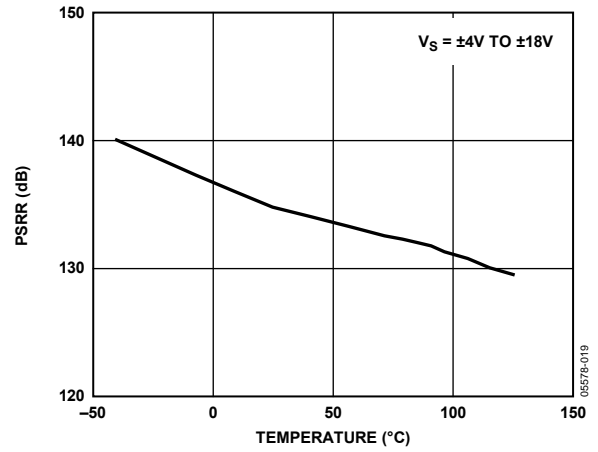

Figure 18. PSRR vs. Temperature

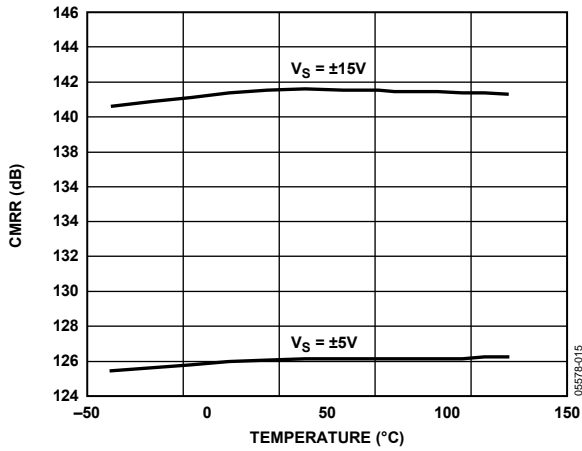

Figure 16. CMRR vs. Temperature

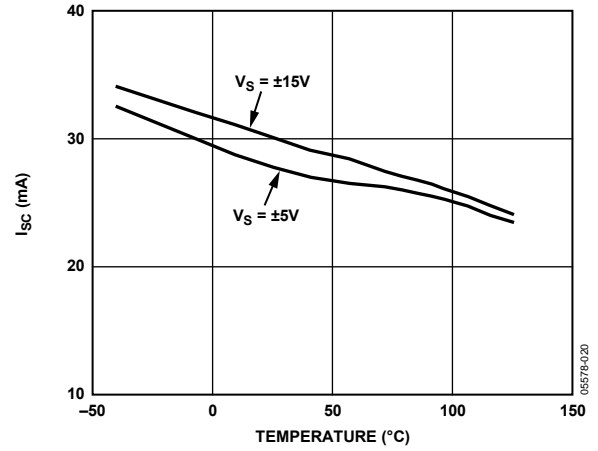

Figure 19. Short Circuit Current vs. Temperature

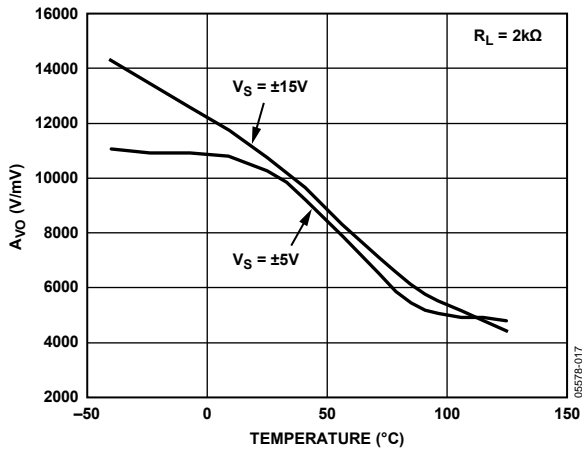

Figure 17. Open-Loop Gain vs. Temperature

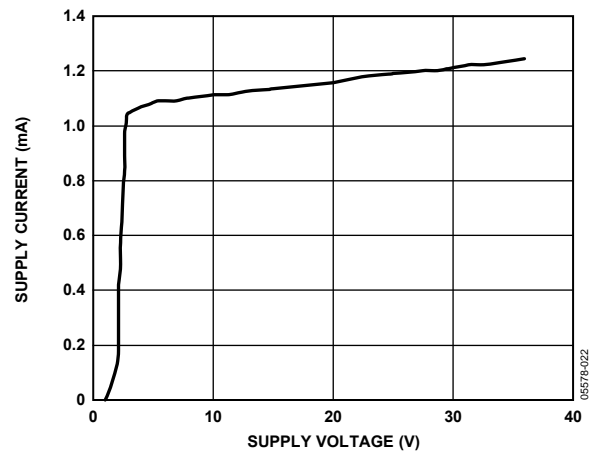

Figure 20. Supply Current vs. Total Supply Voltages

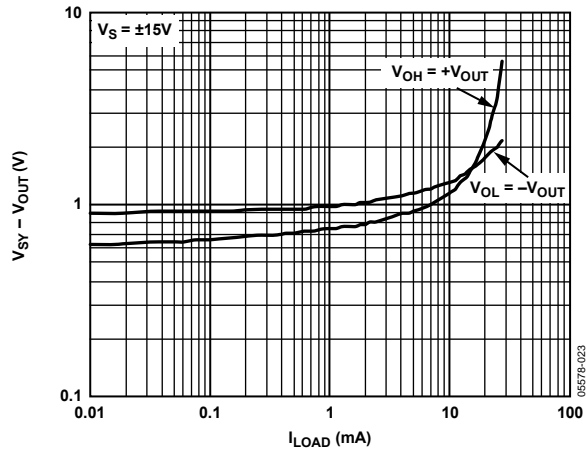

Figure 21. Output Voltage Swing vs. Load Current

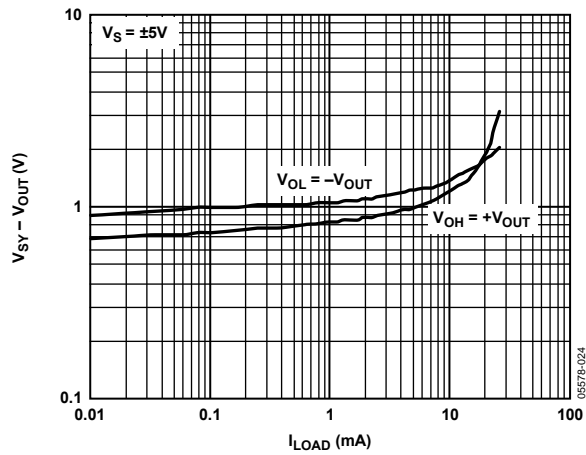

Figure 22. Output Voltage Swing vs. Load Current

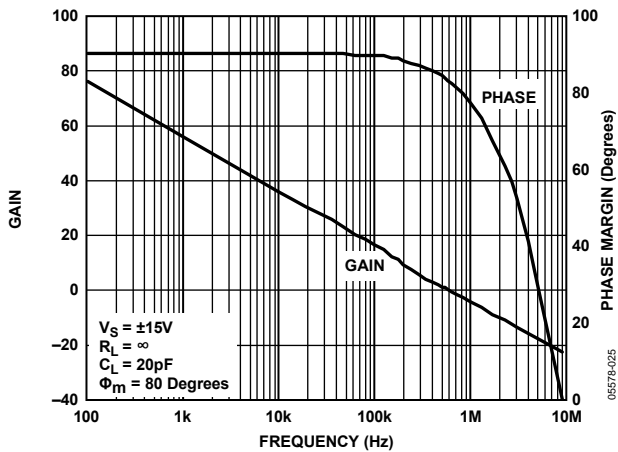

Figure 23. Open-Loop Gain and Phase vs. Frequency

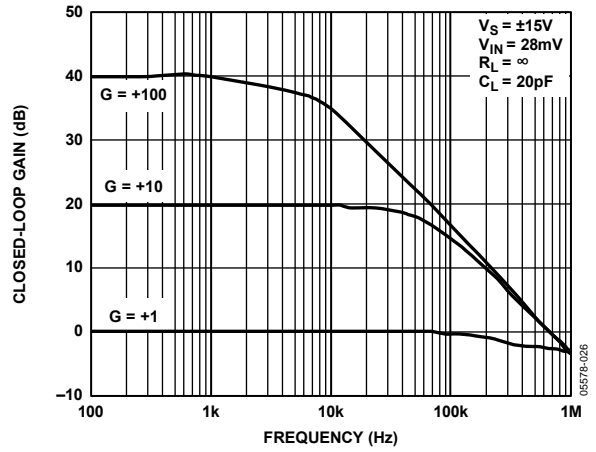

Figure 24. Closed-Loop Gain vs. Frequency

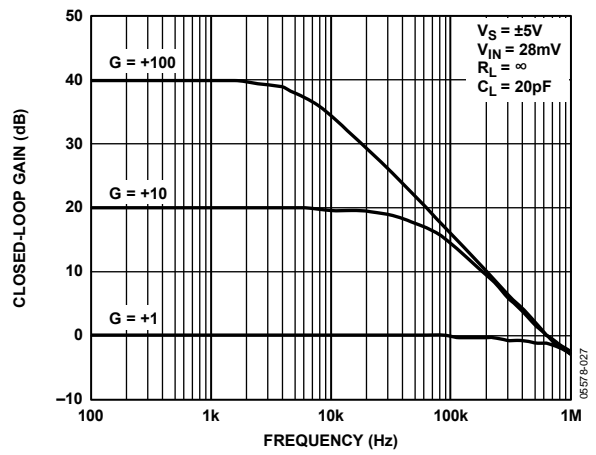

Figure 25. Closed-Loop Gain vs. Frequency

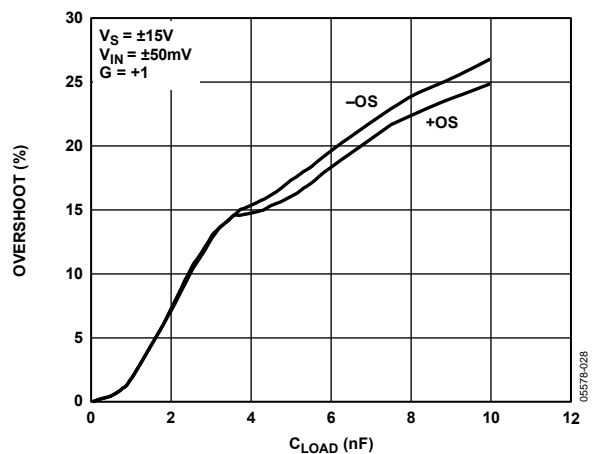

Figure 26. Overshoot vs. Capacitive Load

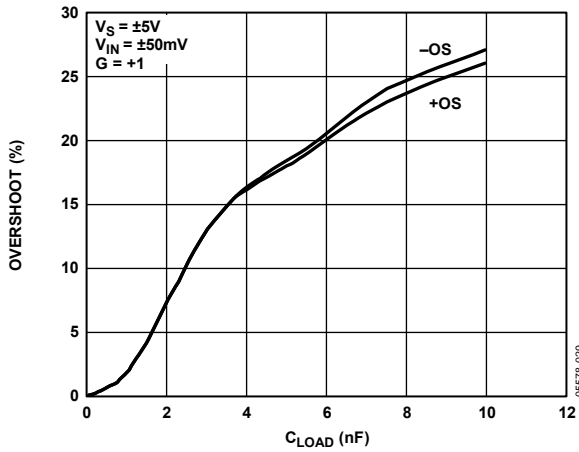

Figure 27. Overshoot vs. Capacitive Load

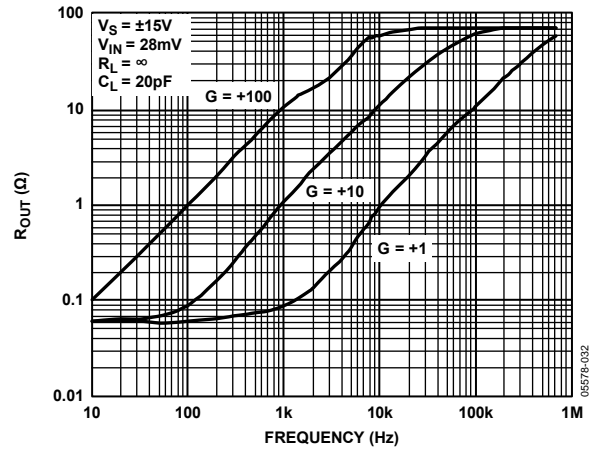

Figure 30. Output Impedance vs. Frequency

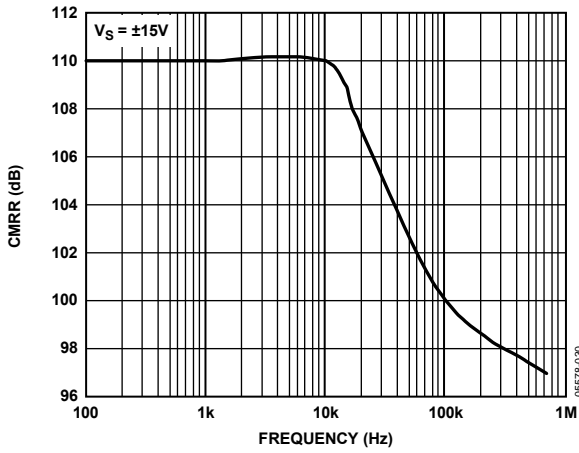

Figure 28. CMRR vs. Frequency

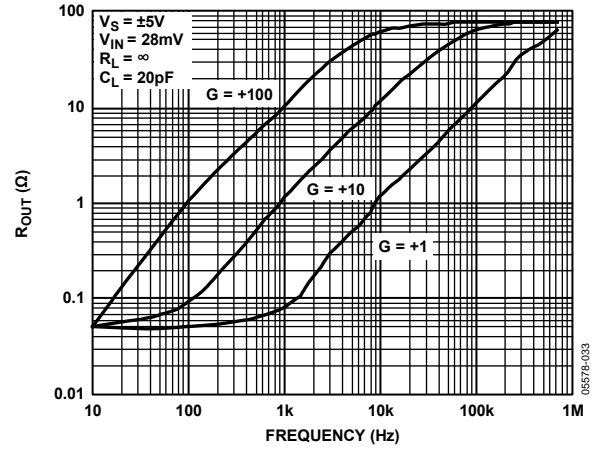

Figure 31. Output Impedance vs. Frequency

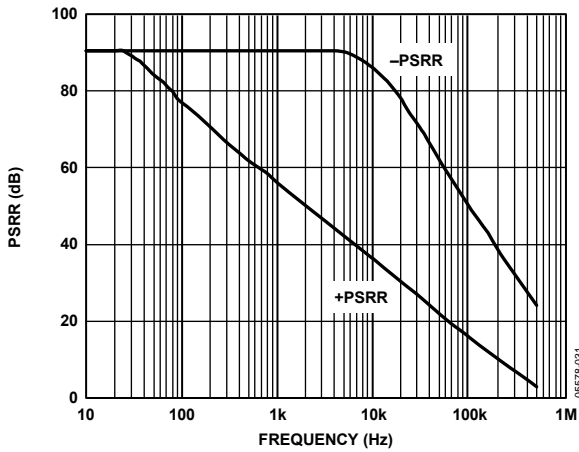

Figure 29. PSRR vs. Frequency

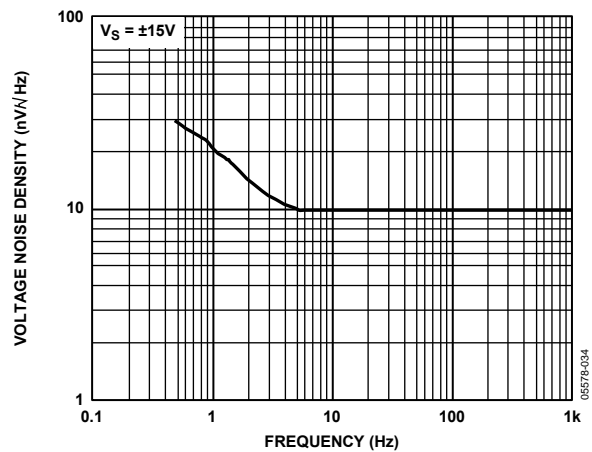

Figure 32. Voltage Noise Density vs. Frequency

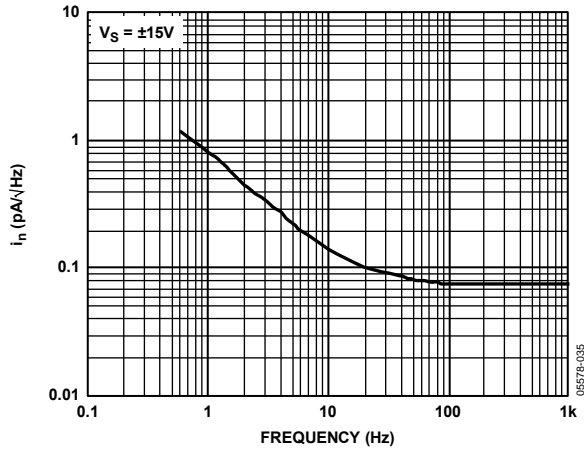

Figure 33. Current Noise Density vs. Frequency

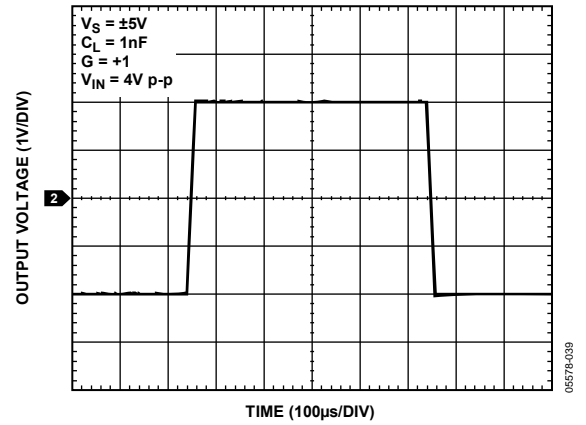

Figure 36. Large Signal Transient

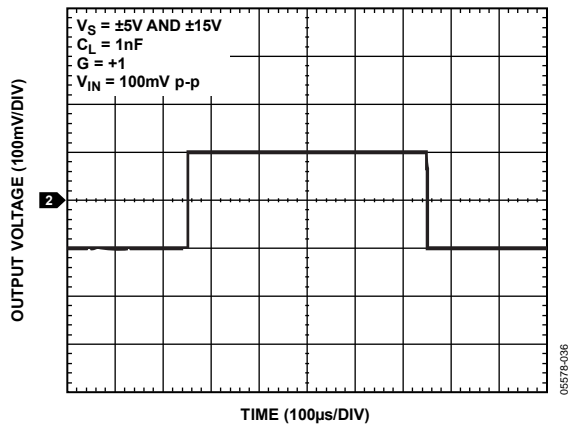

Figure 34. Small Signal Transient

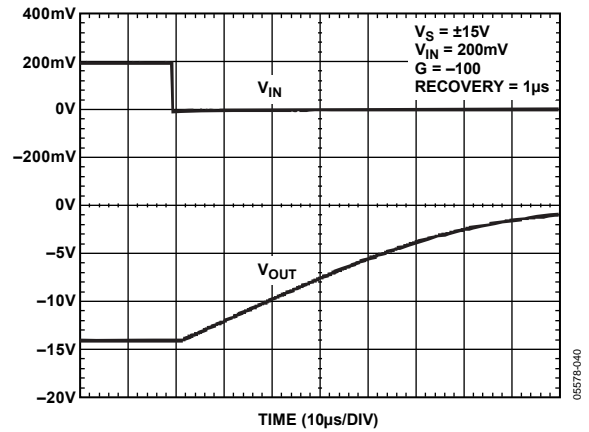

Figure 37. Positive Overload Recovery

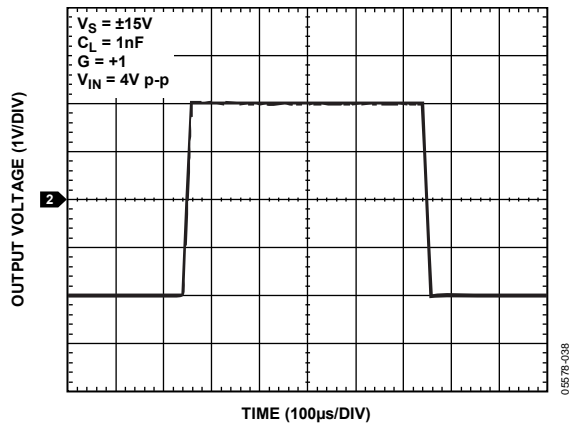

Figure 35. Large Signal Transient

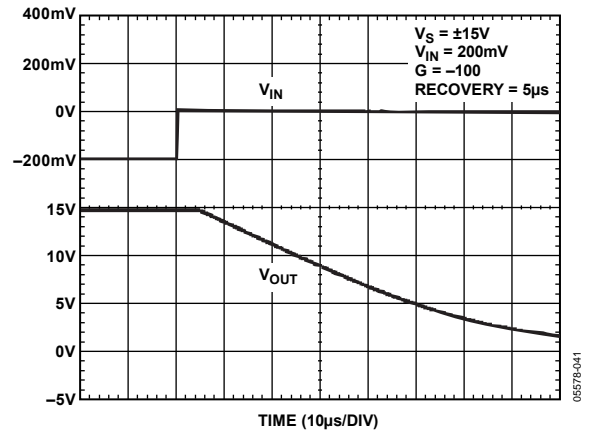

Figure 38. Negative Overload Recovery

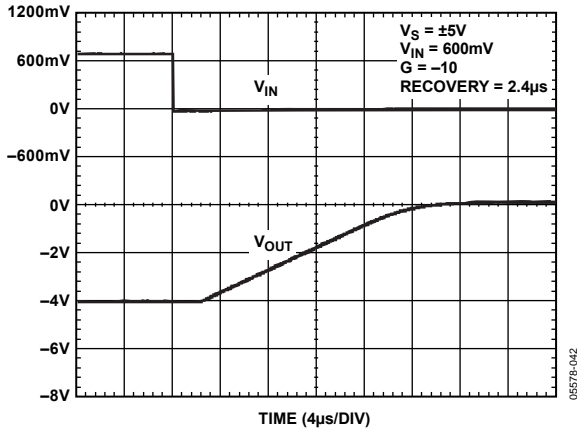

Figure 39. Positive Overload Recovery

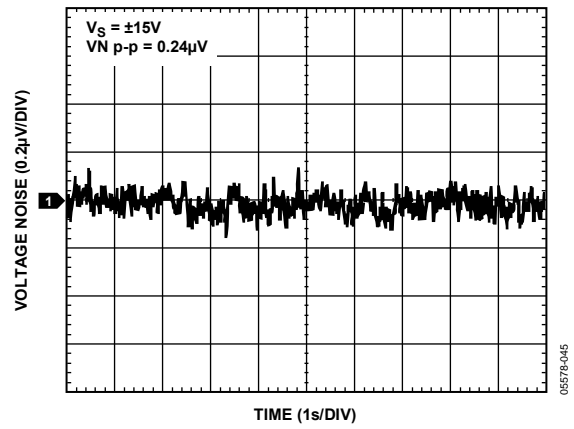

Figure 42. Voltage Noise (0.1 Hz to 10 Hz)

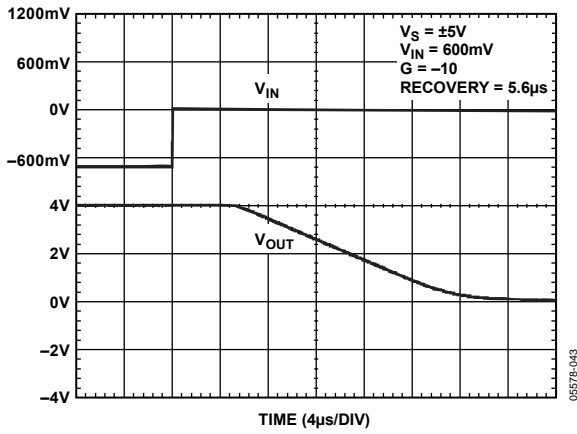

Figure 40. Negative Overload Recovery

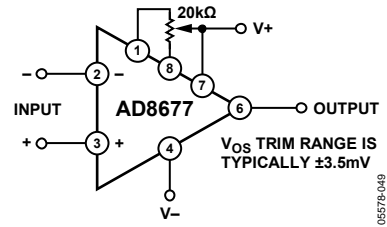

Figure 43. Optional Offset Nulling Circuit

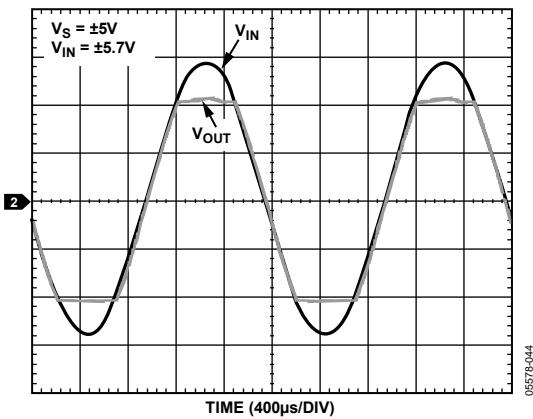
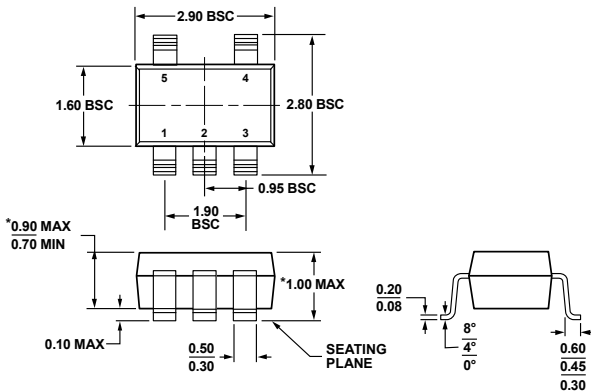

Figure 41. No Phase Reversal

OUTLINE DIMENSIONS



*COMPLIANT TO JEDEC STANDARDS MO-193-AB WITH THE EXCEPTION OF PACKAGE HEIGHT AND THICKNESS.

Figure 44. 5-Lead Thin Small Outline Transistor Package [TSOT] (UJ-5)
Dimensions shown in millimeters

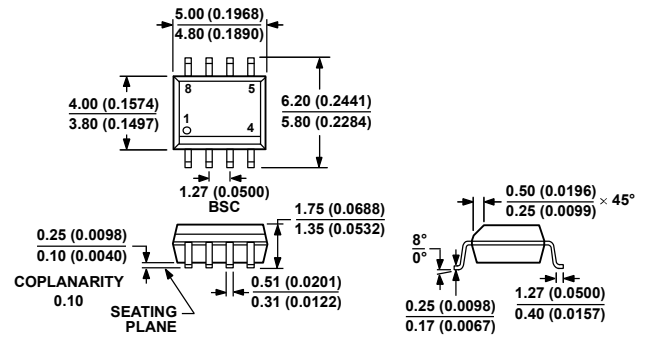

COMPLIANT TO JEDEC STANDARDS MS-012-AA
CONTROLLING DIMENSIONS ARE IN MILLIMETERS; INCH DIMENSIONS (IN PARENTHESES) ARE ROUNDED-OFF MILLIMETER EQUIVALENTS FOR REFERENCE ONLY AND ARE NOT APPROPRIATE FOR USE IN DESIGN.

Figure 45. 8-Lead Standard Small Outline Package [SOIC_N] Narrow Body (R-8)
Dimensions shown in millimeters and (inches)

ORDERING GUIDE

Model ¹	Temperature Range	Package Description	Package Option	Branding
AD8677ARZ	-40°C to +125°C	8-Lead Standard Small Outline Package [SOIC_N]	R-8	
AD8677ARZ-REEL	-40°C to +125°C	8-Lead Standard Small Outline Package [SOIC_N]	R-8	
AD8677ARZ-REEL7	-40°C to +125°C	8-Lead Standard Small Outline Package [SOIC_N]	R-8	
AD8677AUJZ-R2	-40°C to +125°C	5-Lead Thin Small Outline Transistor Package [TSOT]	UJ-5	A0E
AD8677AUJZ-REEL	-40°C to +125°C	5-Lead Thin Small Outline Transistor Package [TSOT]	UJ-5	A0E
AD8677AUJZ-REEL7	-40°C to +125°C	5-Lead Thin Small Outline Transistor Package [TSOT]	UJ-5	A0E

¹ Z = RoHS Compliant Part.

AD8677

NOTES

NOTES

AD8677

NOTES



Компания «ЭлектроПласт» предлагает заключение долгосрочных отношений при поставках импортных электронных компонентов на взаимовыгодных условиях!

Наши преимущества:

- Оперативные поставки широкого спектра электронных компонентов отечественного и импортного производства напрямую от производителей и с крупнейших мировых складов;
- Поставка более 17-ти миллионов наименований электронных компонентов;
- Поставка сложных, дефицитных, либо снятых с производства позиций;
- Оперативные сроки поставки под заказ (от 5 рабочих дней);
- Экспресс доставка в любую точку России;
- Техническая поддержка проекта, помощь в подборе аналогов, поставка прототипов;
- Система менеджмента качества сертифицирована по Международному стандарту ISO 9001;
- Лицензия ФСБ на осуществление работ с использованием сведений, составляющих государственную тайну;
- Поставка специализированных компонентов (Xilinx, Altera, Analog Devices, Intersil, Interpoint, Microsemi, Aeroflex, Peregrine, Syfer, Eurofarad, Texas Instrument, Miteq, Cobham, E2V, MA-COM, Hittite, Mini-Circuits, General Dynamics и др.);

Помимо этого, одним из направлений компании «ЭлектроПласт» является направление «Источники питания». Мы предлагаем Вам помощь Конструкторского отдела:

- Подбор оптимального решения, техническое обоснование при выборе компонента;
- Подбор аналогов;
- Консультации по применению компонента;
- Поставка образцов и прототипов;
- Техническая поддержка проекта;
- Защита от снятия компонента с производства.



Как с нами связаться

Телефон: 8 (812) 309 58 32 (многоканальный)

Факс: 8 (812) 320-02-42

Электронная почта: org@eplast1.ru

Адрес: 198099, г. Санкт-Петербург, ул. Калинина, дом 2, корпус 4, литера А.