

LOC		DIST		REVISIONS			
P	LTN	DESCRIPTION	DATE	DMN	APVD		
E8		REV PER ECR-12-021802	04JAN2013	ML	SZ		
E9		ADD NEW DASH NUMBER 2-3	21MAY2013	CZ	SZ		

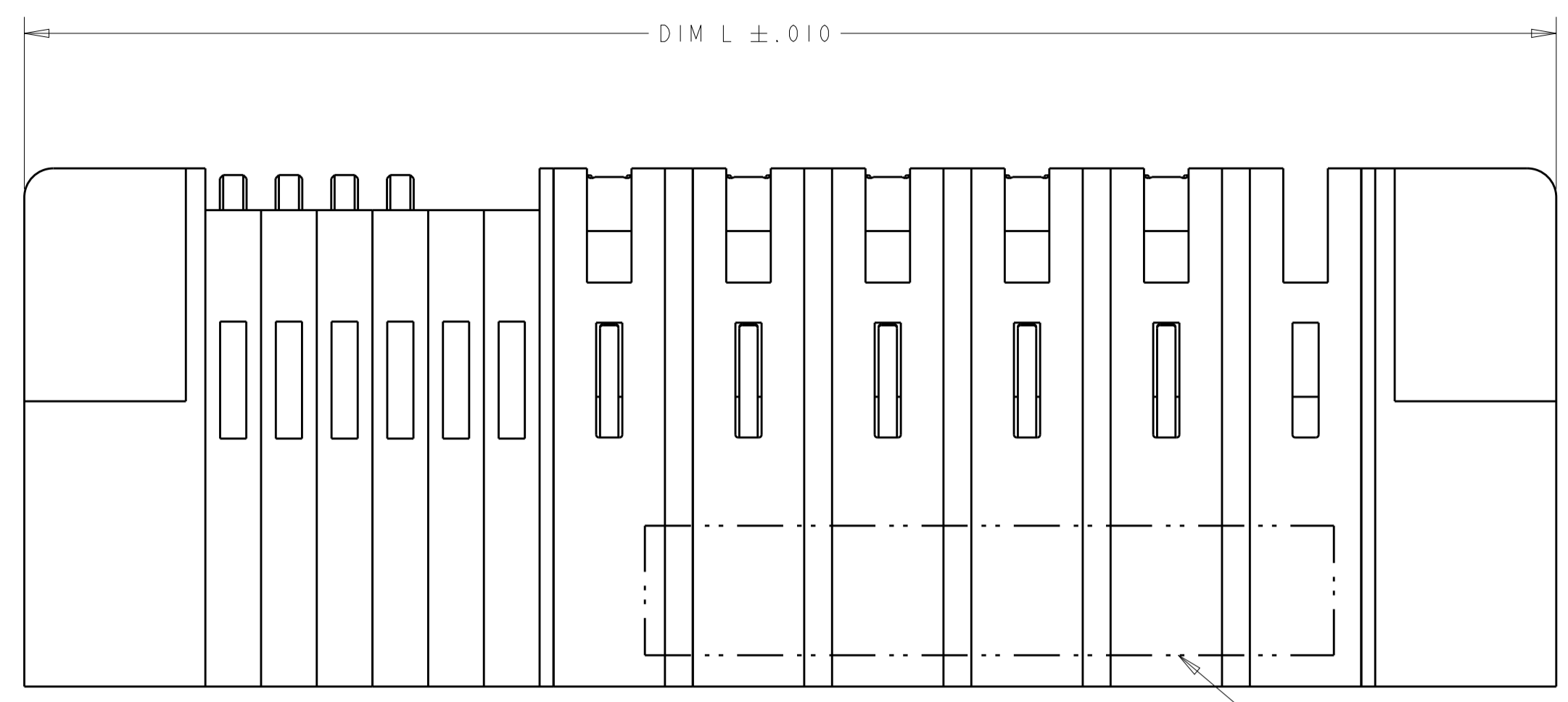

- ⚠ "AMP", PART NUMBER, AND DATE CODE TO BE MARKED IN AREA SHOWN.
- ⚠ MATERIAL: HOUSING - GLASS FILLED HIGH TEMP THERMO PLASTIC, UL94 V-0
 SIGNAL CONTACT - COPPER ALLOY
 POWER CONTACT - HIGH CONDUCTIVITY COPPER ALLOY
- ⚠ CONTACT PLATING: NOBLE METAL PLATING ON CONTACT FUNCTIONAL AREA OF POWER CONTACTS AND SIGNAL CONTACTS.
- ⚠ MECHANICAL CONNECTOR KEEP OUT ZONE.
- ⚠ DATUM AND BASIC DIMENSIONS ESTABLISHED BY CUSTOMER.
- ⚠ PCB - ALL HOLE DIAMETERS ARE FINISHED HOLE SIZES.
- ⚠ PCB - .0453±.0010 DRILLED HOLES PLATED WITH .0003 MIN Sn OVER .001 TO .003 CU PLATING TO ACHIEVE A .040±.003 DIA HOLE

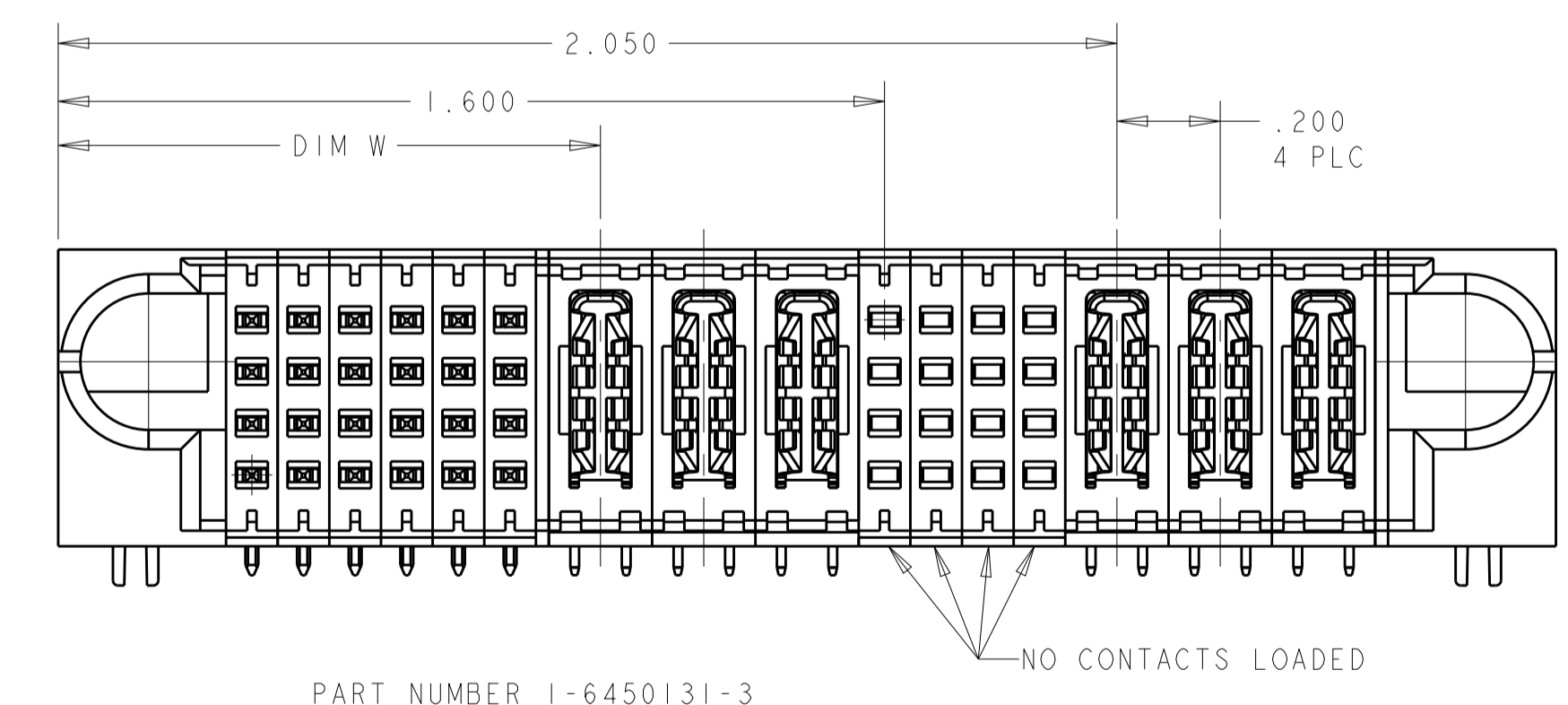
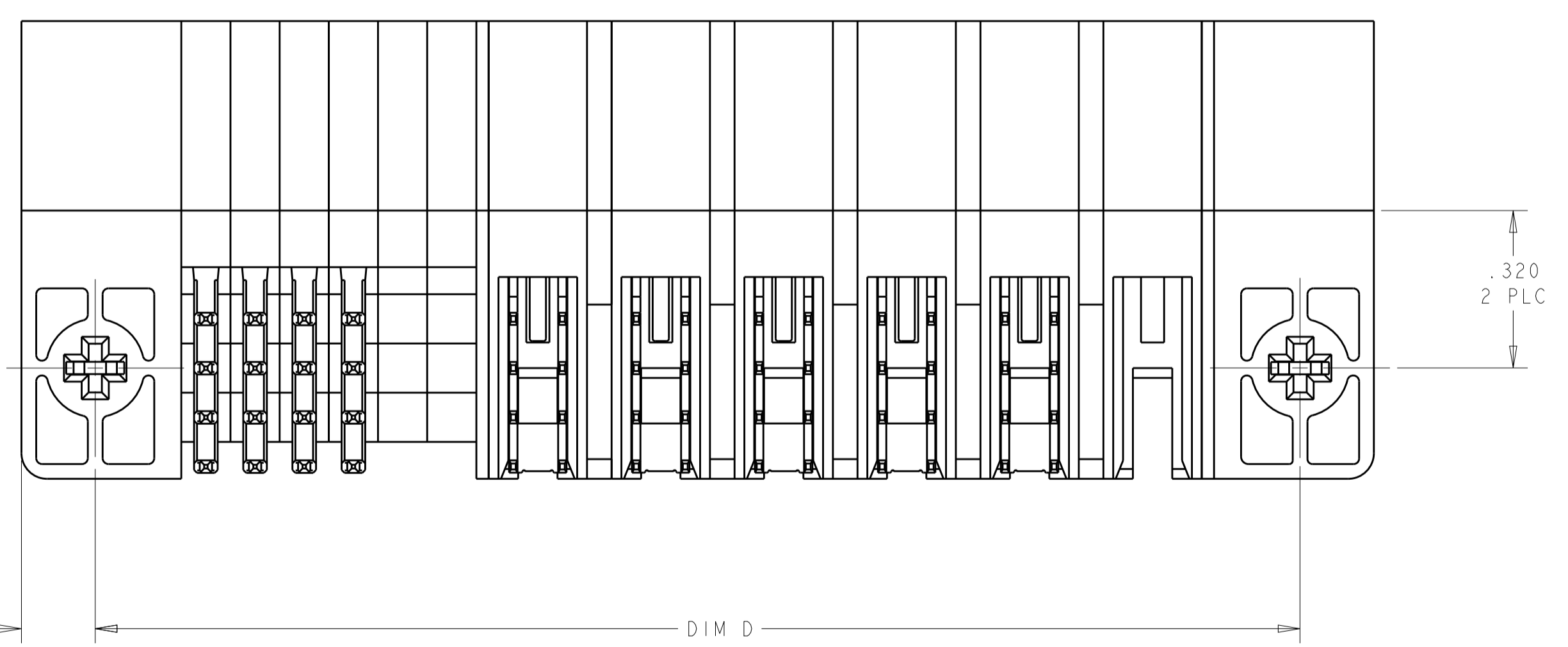
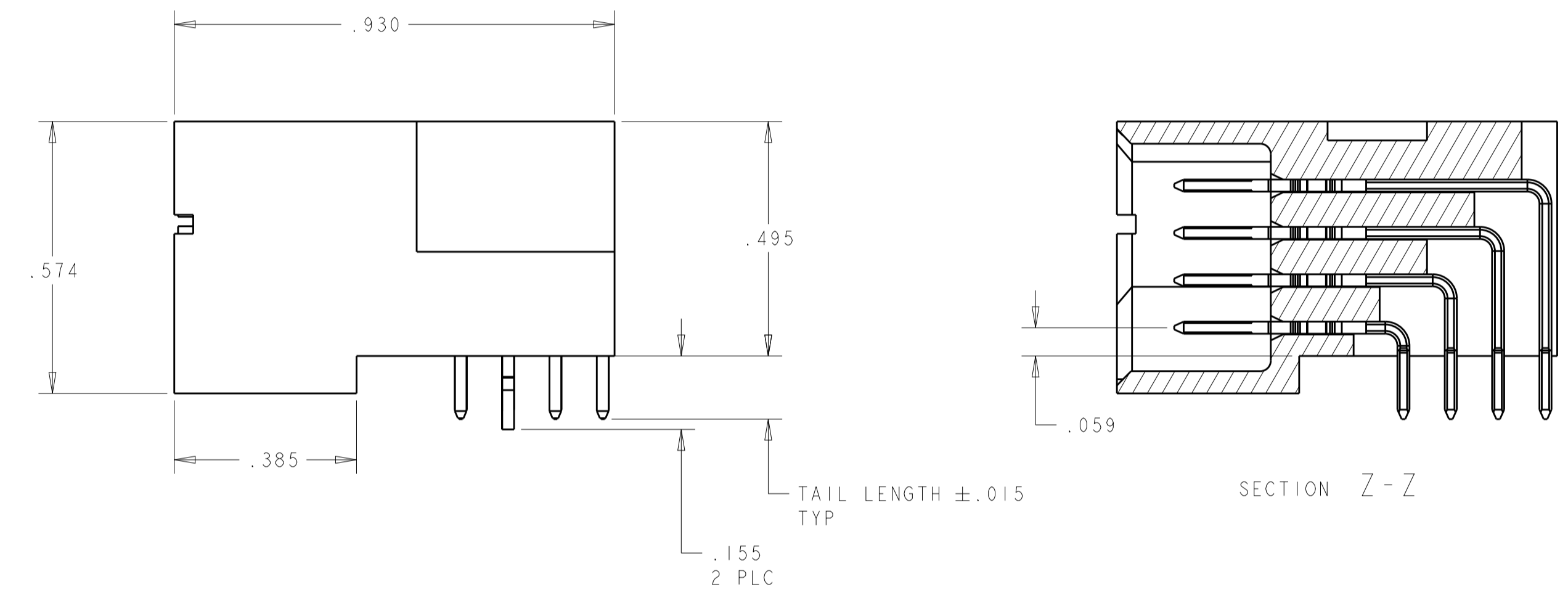
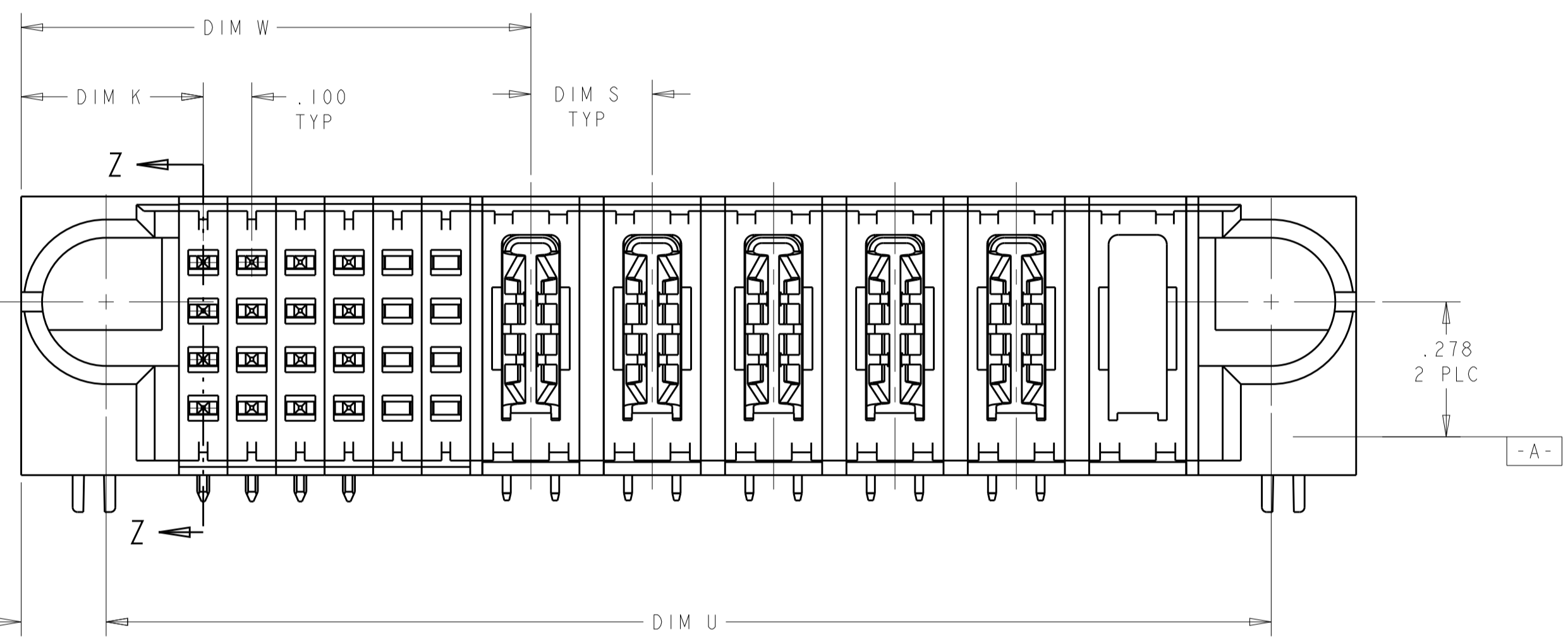

PART NUMBER 1-6450131-3

THIS DRAWING IS A CONTROLLED DOCUMENT.		DMN R. GRZYBOWSKI 15FEB05	TE Connectivity
DIMENSIONS: INCHES		CHK M. PERCHERKE 15FEB05	
TOLERANCES UNLESS OTHERWISE SPECIFIED:		APVD M. PERCHERKE	NAME
0 PLC ±. 1 PLC ±. 2 PLC ±.01 3 PLC ±.005 4 PLC ±.0020 ANGLES ±.2°		PRODUCT SPEC 108-1973	RIGHT ANGLE HEADER ASSY SOLDER CONTACTS, W/GUIDES MULTI-BEAM XL
MATERIAL		APPLICATION SPEC 114-13038	SIZE
FINISH		WEIGHT	CAGE CODE DRAWING NO A100779C=6450131
		CUSTOMER DRAWING	RESTRICTED TO
		SCALE 1:1	SHEET 1 of 9 REV E9

LOC	DIST	REVISIONS					
		P.	LTN	DESCRIPTION	DATE	DWN	APVD
ES	00	-	-	SEE SHEET 1	-	-	-

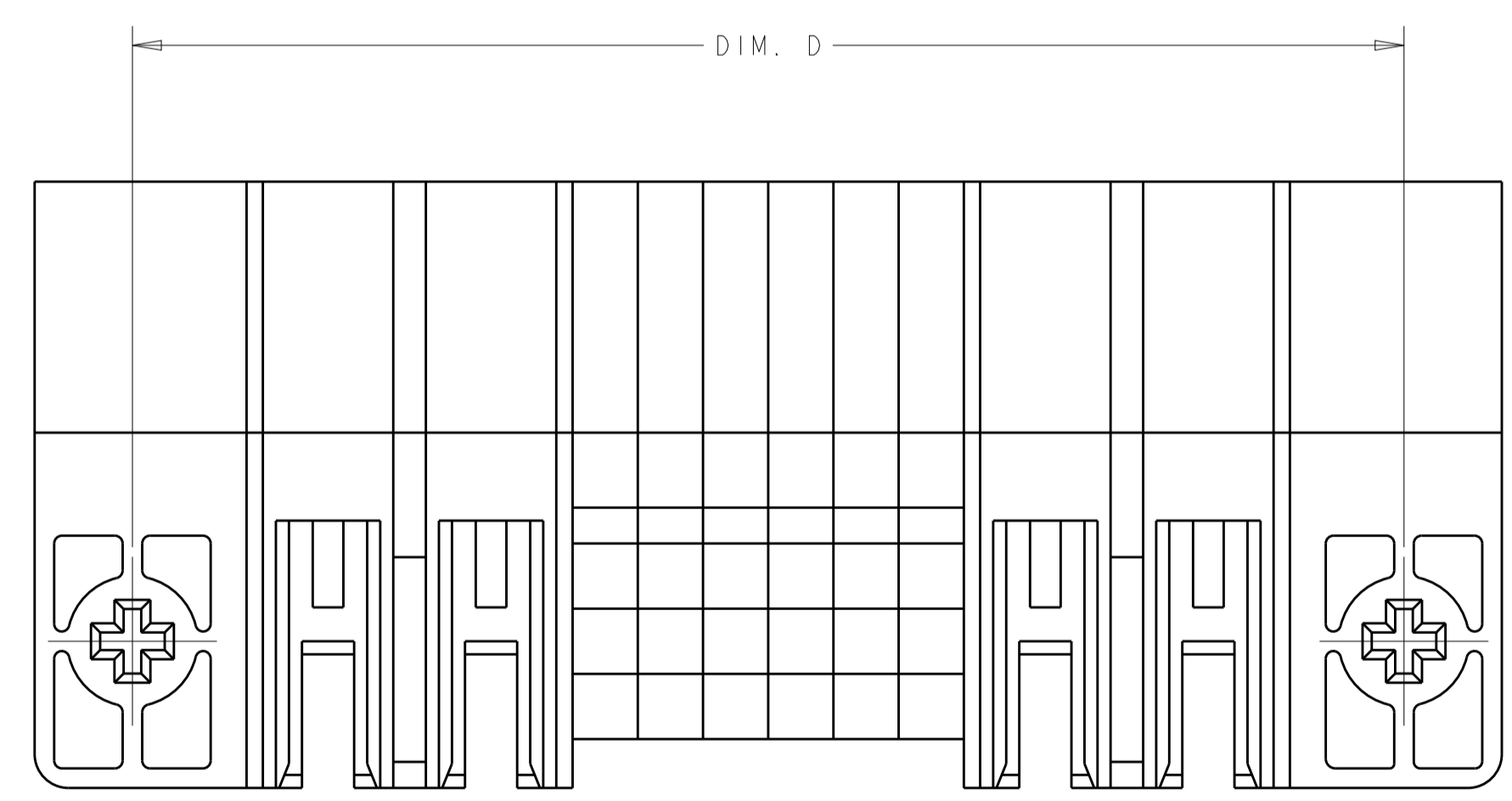
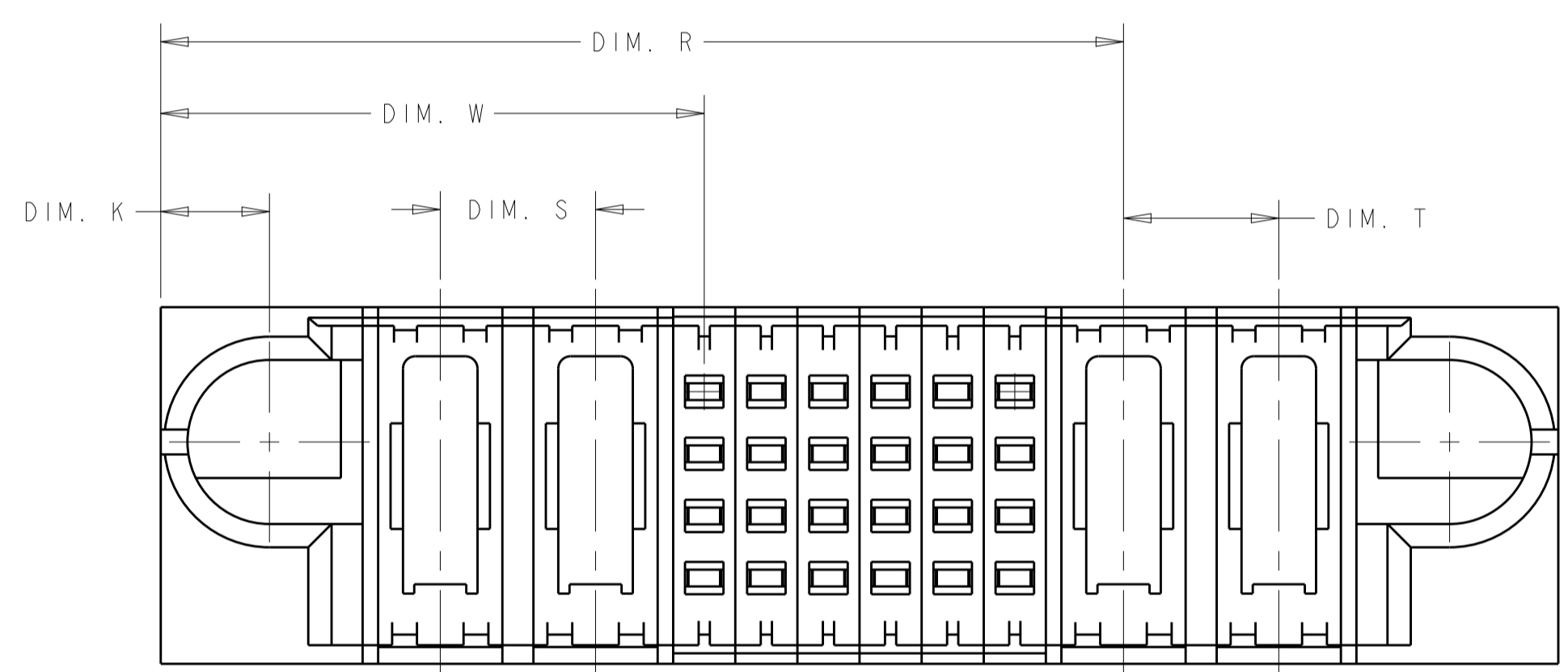
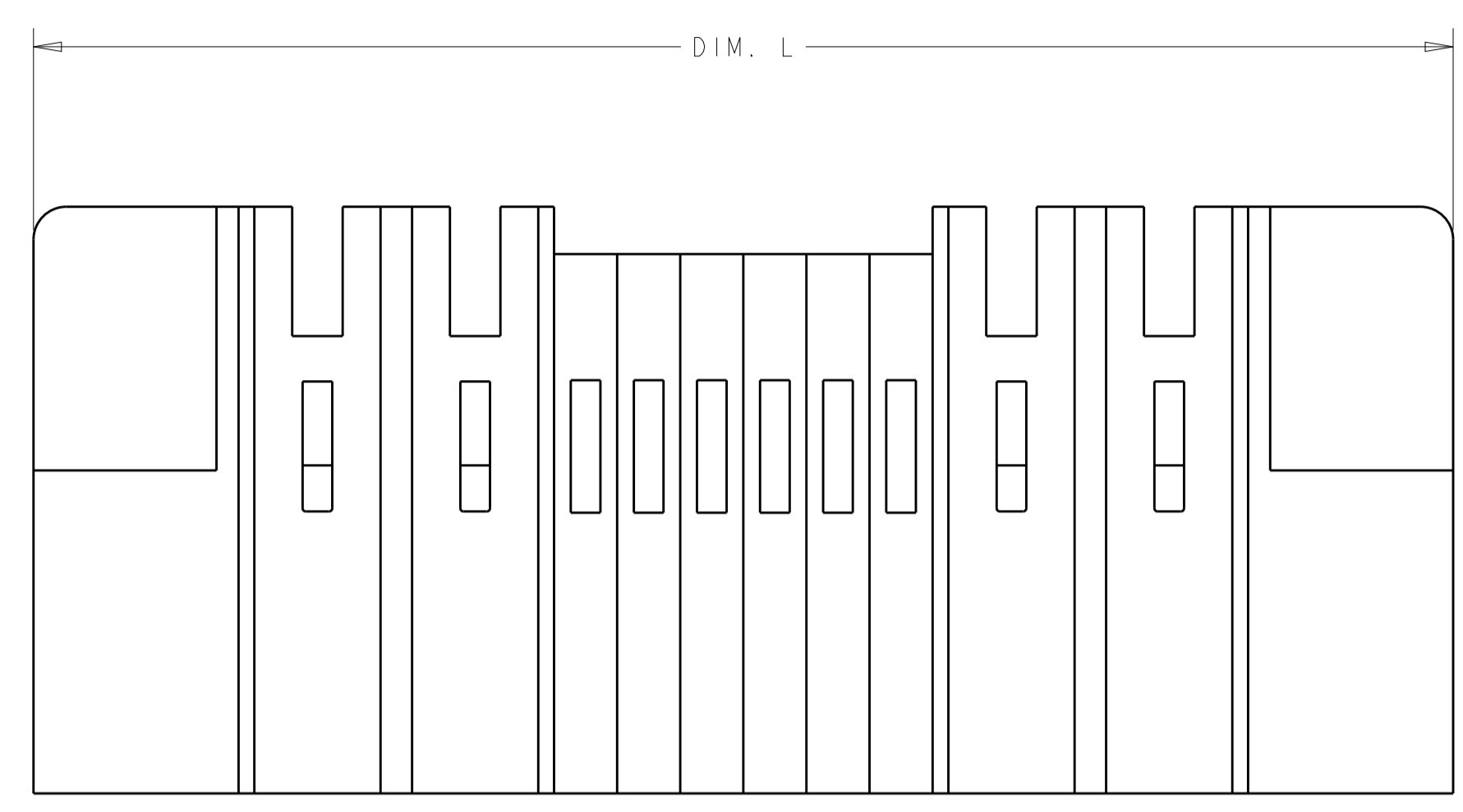

PART 2-6450131-1
(NO CONTACT VIEW)

DIM R	DIM T	DIM U	DIM S	DIM K	DIM D	DIM W	DIM L	DESCRIPTION	PART NUMBER
-	-	4.650	.250	.400	4.700	1.800	5.000	52S + 12P	2-6450131-3
-	-	1.700	.250	.375	1.750	.850	2.050	16S + 4P	2-6450131-2
1.550	.250	1.900	.250	.450	1.950	.875	2.250	24S	2-6450131-1
		1.600	.250	.375	1.650	.750	1.950	12S + 4P	1-6450131-9
		3.650	.250	.400	3.700	1.300	4.000	32S + 10P	1-6450131-8
		2.950	.200	.375	3.000	1.050	3.300	24S + 10HDP	1-6450131-7
		2.400	.250	.375	2.450	1.050	2.750	24S + 6P	1-6450131-6
		2.450	.200	.375	2.500	.950	2.800	20S + 8P	1-6450131-5
		2.400	.250	.375	2.450	1.050	2.750	24S + 6P	1-6450131-4
		2.550	.200	.375	2.600	1.050	2.900	24S + 3P + 16S + 3P	1-6450131-3
		2.500	.250	.425	2.550	.875	2.850	12S + 7P	1-6450131-1
		2.400	.250	.375	2.450	1.050	2.750	24S + 6P	6450131-7
		2.700	.300	.375	2.750	.775	3.050	12S + 7ACP	6450131-6
		2.400	.250	.375	2.450	1.050	2.750	24S + 6P	6450131-5
		4.400	.250	.375	4.450	1.050	4.750	24S + 14P	6450131-4
		1.950	.250	.375	2.000	.850	2.300	16S + 5P	6450131-3

THIS DRAWING IS A CONTROLLED DOCUMENT.

DIMENSIONS: INCHES

TOLERANCES UNLESS OTHERWISE SPECIFIED:

0 PLC	±
1 PLC	±.01
2 PLC	±.01
3 PLC	±.005
4 PLC	±.0020
ANGLES	±.020
FINISH	±.020

MATERIAL: - FINISH: -

THIS DRAWING IS A CONTROLLED DOCUMENT. DWN: R. GRZYBOWSKI 15FEB05 CHK: M. PERCHERKE 15FEB05 APVD: M. PERCHERKE NAME: -

PRODUCT SPEC: 108-1973 APPLICATION SPEC: 114-13038 WEIGHT: -

CUSTOMER DRAWING

SCALE: 1:1 SHEET: 2 OF 9 REV: E9

STE TE Connectivity

RIGHT ANGLE HEADER ASSY
SOLDER CONTACTS, W/GUIDES
MULTI-BEAM XL

SIZE: A1 CAGE CODE: 6450131 DRAWING NO: 100779

LOC	DIST	REV	DATE	BY	APPD
ES	00				

REVISIONS		DATE	BY	APPD
1	SEE SHEET 1			

PART NUMBER	ROWS	SIGNAL				POWER					
		1	2	3	4	P1	P2	P3	P4	P5	
6450131-3	D	J	J	J	J	PM	PM	PM	PM	PM	
	C	K	K	K	K						
	B	N	N	N	N						
	A	S	S	S	H						
16S + 5P		HD									

PART NUMBER	ROWS	SIGNAL						POWER														
		1	2	3	4	5	6	P1	P2	P3	P4	P5	P6	P7	P8	P9	P10	P11	P12	P13	P14	
6450131-4	D	J	J	J	J	J	J	PM	PM	PM	PM	PM	PM	PM	PM	PM	PM	PM	PM	PM	PM	PM
	C	K	K	K	K	K	K															
	B	N	N	N	N	N	N															
	A	S	S	H	H	S	S															
24S + 14P		HD																				

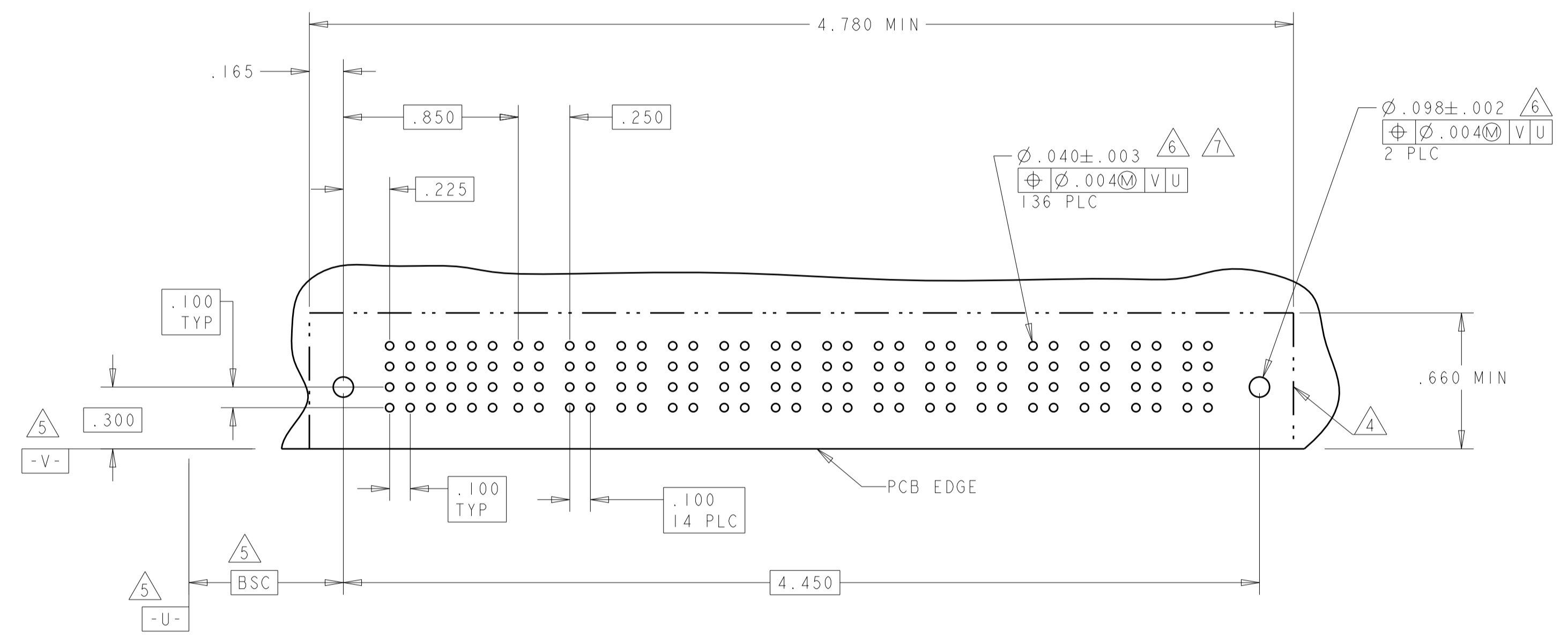
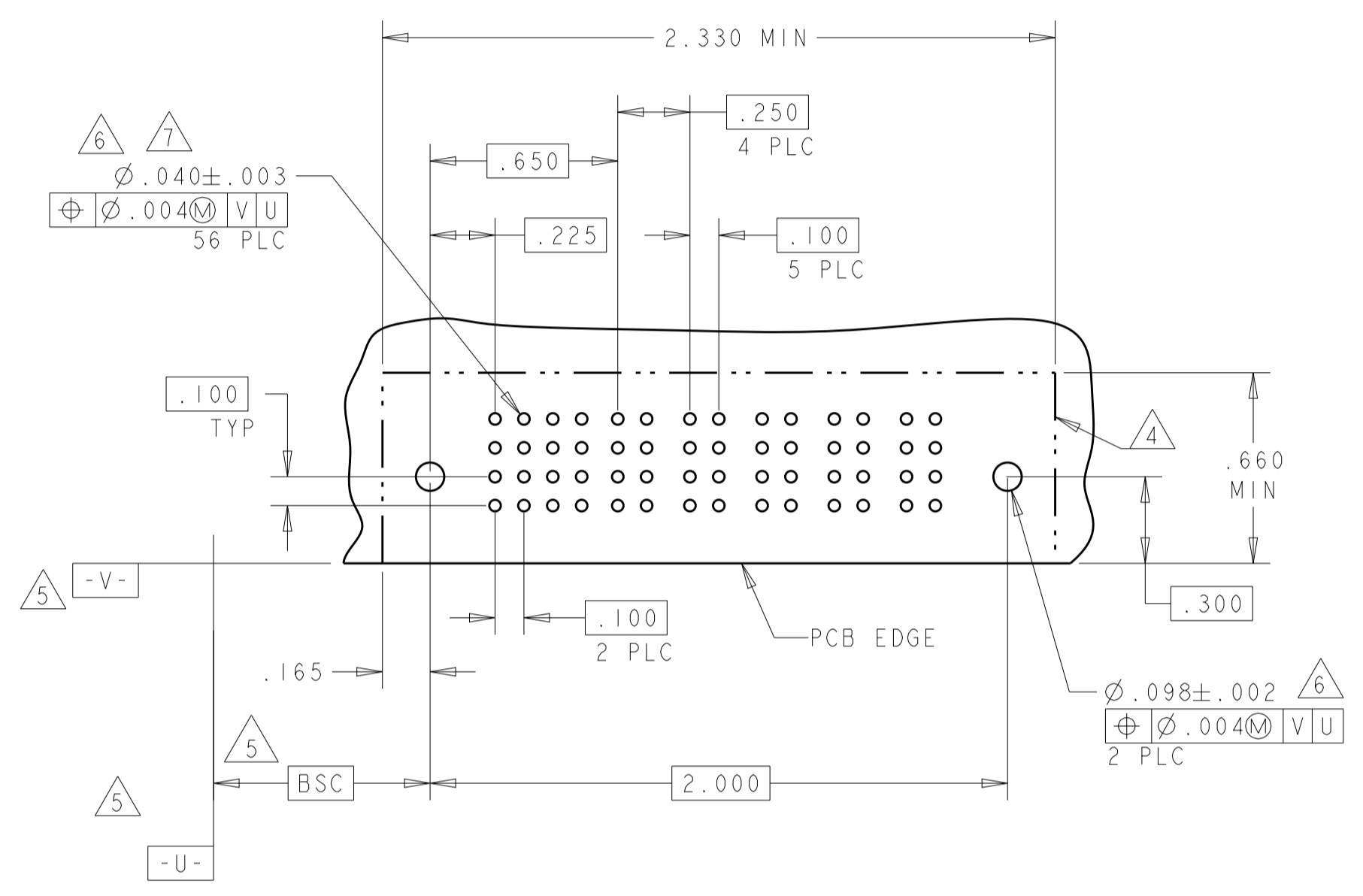

PART NUMBER	ROWS	SIGNAL						POWER					
		1	2	3	4	5	6	P1	P2	P3	P4	P5	P6
6450131-5	D	J	J	J	J	J	E	PM	PM	PM	PM	PM	PM
	C	K	K	K	K	K	K						
	B	N	N	N	N	N	N						
	A	H	S	S	S	S	S						
24S + 6P		HD											

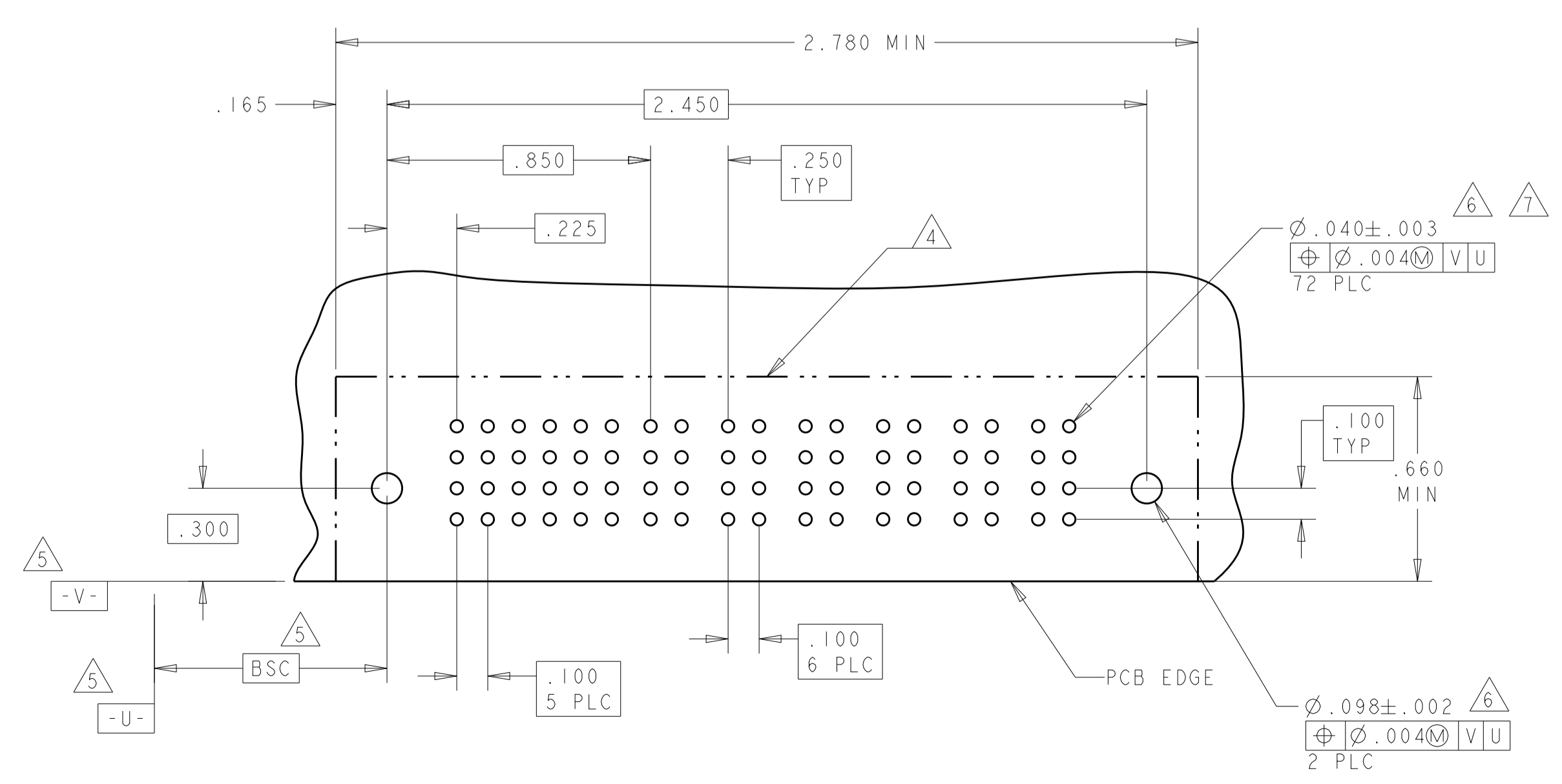

Z	STD	.090	D
Y	STD	.090	C
R	STD	.090	B
O	STD	.090	A
A4	MLBF	.090	D
A3	MLBF	.090	C
A2	MLBF	.090	B
A1	MLBF	.090	A
E	MLBF	.135	D
F	MLBF	.135	C
G	MLBF	.135	B
H	MLBF	.135	A
FJ	MFLB	.135	D
J	STD	.135	D
K	STD	.135	C
N	STD	.135	B
S	STD	.135	A

CODE	TAIL LENGTH
PA	.090
PM	.135

CODE	MATING SEQUENCE	TAIL LENGTH	ROW
SIGNAL CONTACT			

CODE	TAIL LENGTH
PA	.090
PM	.135

THIS DRAWING IS A CONTROLLED DOCUMENT.

DIMENSIONS: INCHES	TOLERANCES UNLESS OTHERWISE SPECIFIED:	0 PLC ± .01	1 PLC ± .01	2 PLC ± .01	3 PLC ± .01	4 PLC ± .01	5 PLC ± .01	6 PLC ± .01	7 PLC ± .01	8 PLC ± .01	9 PLC ± .01	10 PLC ± .01	11 PLC ± .01	12 PLC ± .01	13 PLC ± .01	14 PLC ± .01	15 PLC ± .01	16 PLC ± .01	17 PLC ± .01	18 PLC ± .01	19 PLC ± .01	20 PLC ± .01	21 PLC ± .01	22 PLC ± .01	23 PLC ± .01	24 PLC ± .01
--------------------	--	-------------	-------------	-------------	-------------	-------------	-------------	-------------	-------------	-------------	-------------	--------------	--------------	--------------	--------------	--------------	--------------	--------------	--------------	--------------	--------------	--------------	--------------	--------------	--------------	--------------

MATERIAL: - FINISH: - WEIGHT: -

APPROVED: M. PERCHERKE

DATE: 108-1973

SCALE: 1:1 SHEET 3 OF 9

REV: E9

PART NUMBER	ROWS	SIGNAL			POWER						
		1	2	3	P1	P2	P3	P4	P5	P6	P7
6450131-6	D C B A	Z	Z	Z	PA	PA	PA	PA	PA	PA	PA
		Y	Y	Y							
		R	R	R							
		A	O	O							

PART NUMBER	ROWS	SIGNAL			POWER						
		1	2	3	P1	P2	P3	P4	P5	P6	P7
I-6450131-1	D C B A	J	J	J	PM	PM	PM	PM	PM	PM	PM
		K	K	K							
		N	N	N							
		S	S	S							

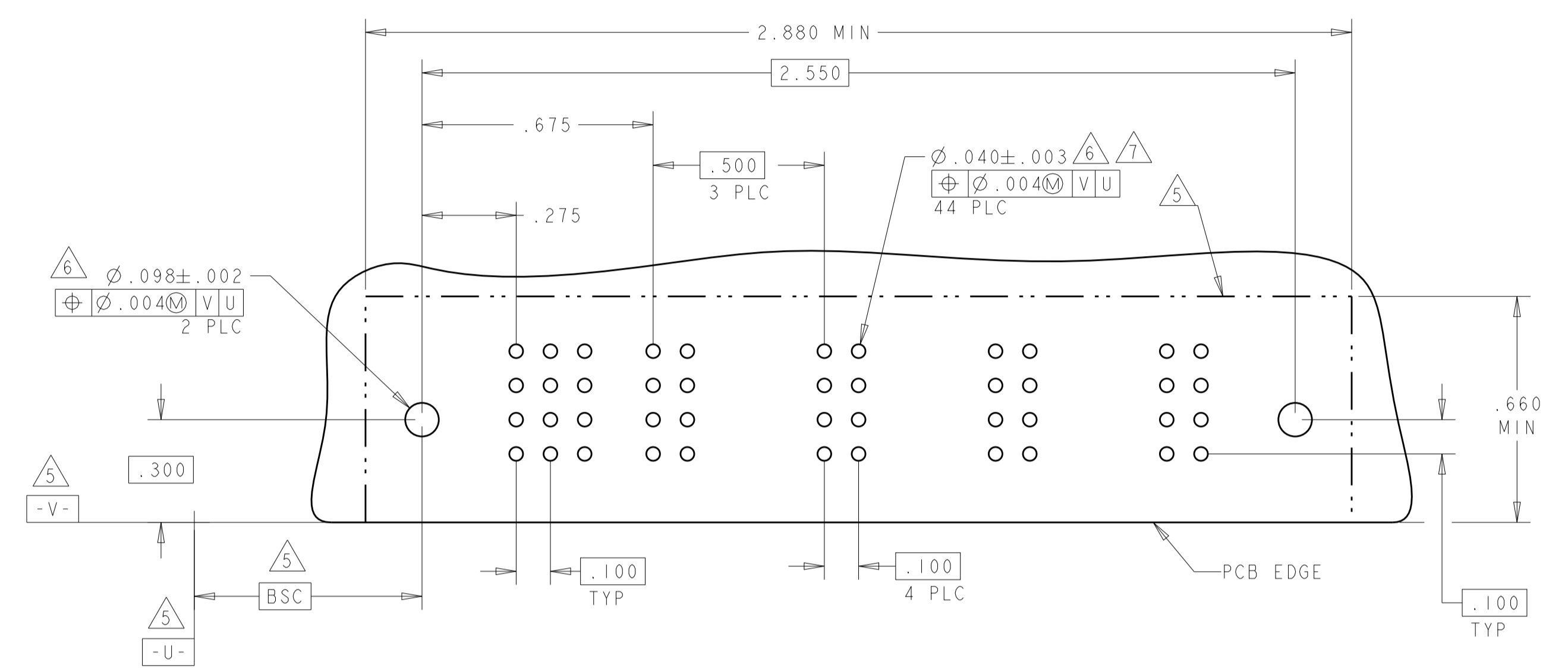
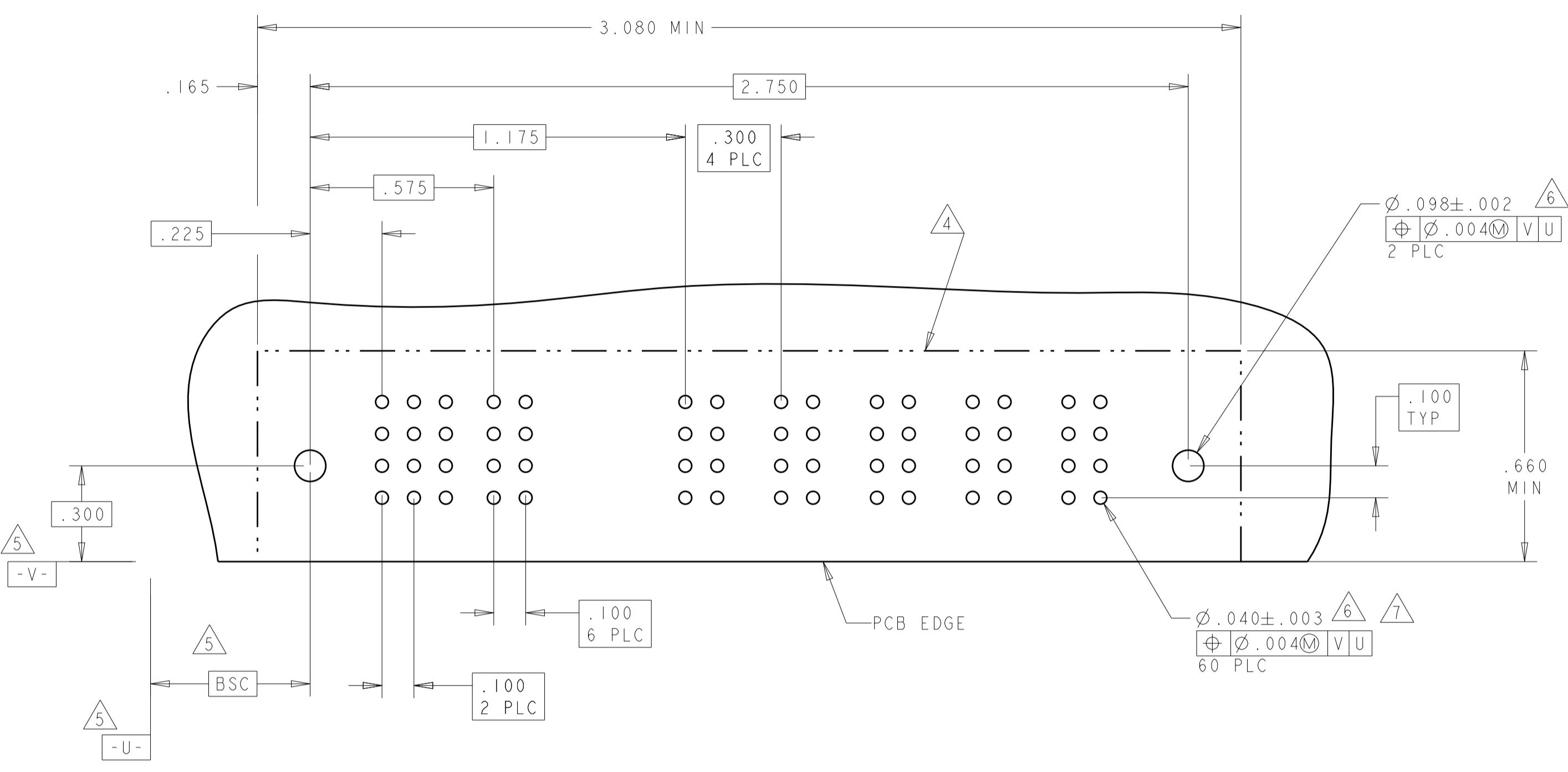

PART NUMBER	ROWS	SIGNAL						POWER					
		1	2	3	4	5	6	P1	P2	P3	P4	P5	P6
6450131-7	D C B A	E	E	J	J	J	E	PM	PM	PM	PM	PM	PM
		F	F	K	K	K	K						
		G	G	N	N	N	N						
		H	H	S	S	S	S						

PART NUMBER	ROWS	SIGNAL						POWER			SIGNAL				POWER		
		1	2	3	4	5	6	P1	P2	P3	7	8	9	10	P4	P5	P6
I-6450131-3	D C B A	J	J	J	J	J	E	PM	PM	PM					PM	PM	PM
		K	K	K	K	K	K										
		N	N	N	N	N	N										
		H	S	S	S	S	S										

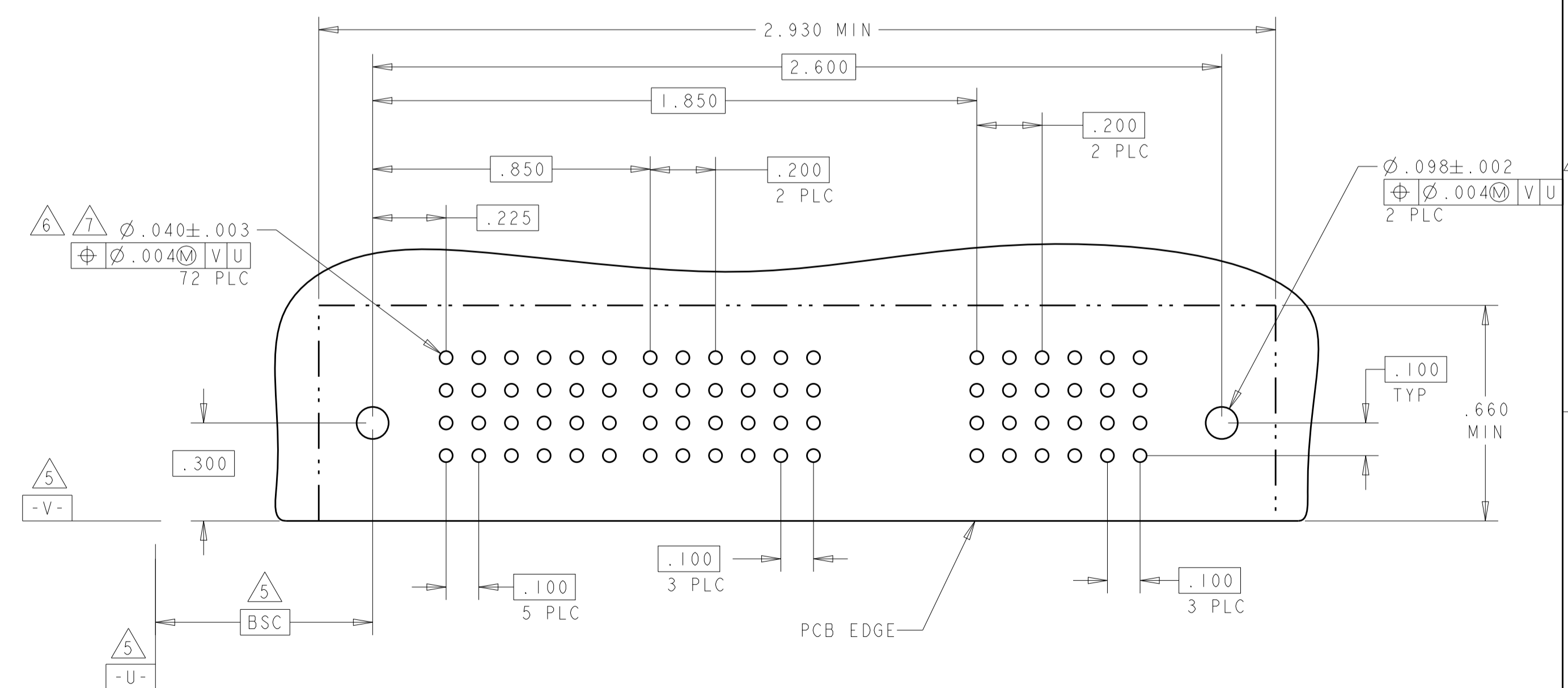
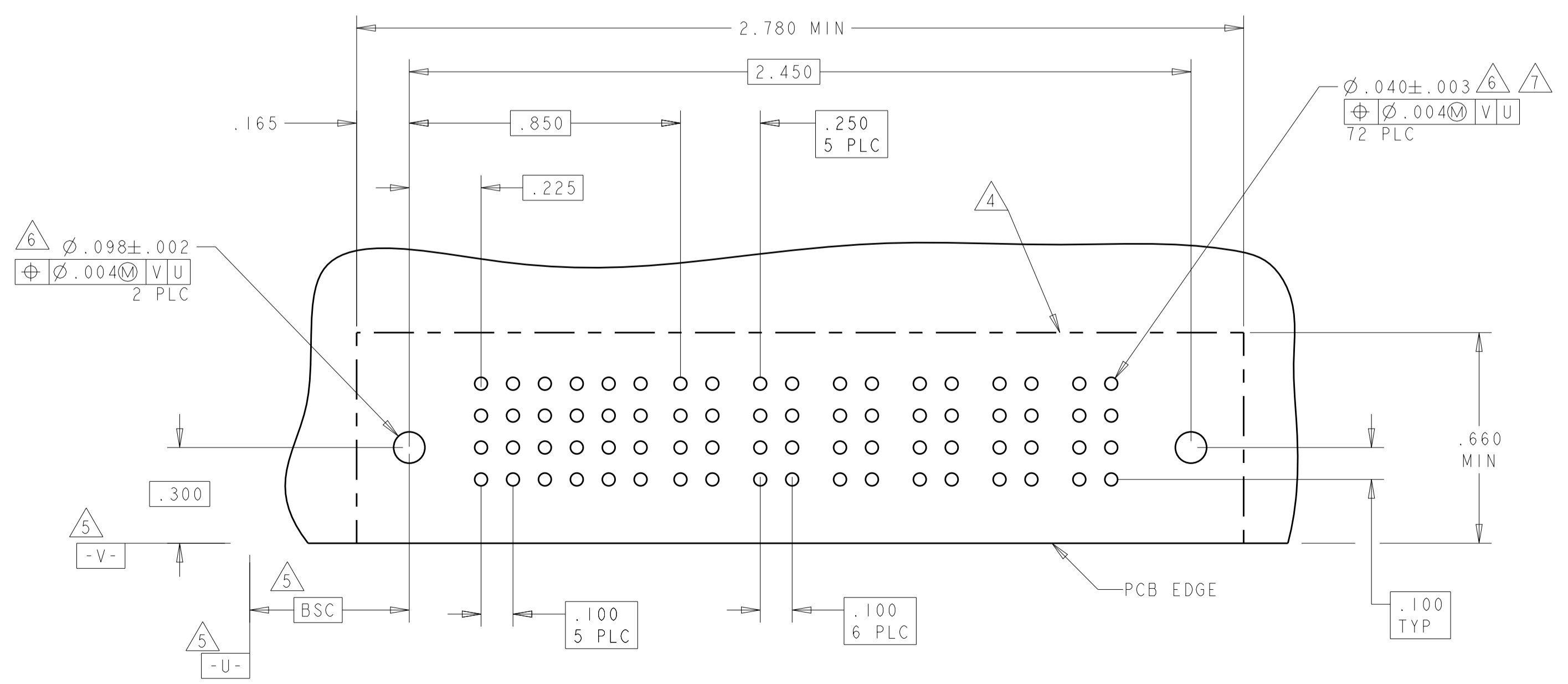

THIS DRAWING IS A CONTROLLED DOCUMENT.

DIMENSIONS: INCHES	TOLERANCES UNLESS OTHERWISE SPECIFIED: 0 PLC ±.01 1 PLC ±.01 2 PLC ±.01 3 PLC ±.005 4 PLC ±.002 ANGLES ±.020	DWN: R. GRZYBOWSKI CHK: M. PERCHERKE APVD: M. PERCHERKE	15FEB05 15FEB05
MATERIAL:	FINISH:	NAME: RIGHT ANGLE HEADER ASSY PRODUCT SPEC: 108-1973 APPLICATION SPEC: 114-13038	RESTRICTED TO:
CUSTOMER DRAWING		SCALE: 1:1	SHEET 4 OF 9

STC TE Connectivity

LOC		DIST		REVISIONS			
ES	00	P	LTN	DESCRIPTION	DATE	OWN	APVD
				SEE SHEET 1			

PART NUMBER	ROWS	SIGNAL						POWER							
		1	2	3	4	5	6	P1	P2	P3	P4	P5	P6		
1-6450131-4	D	J	J	J	J	J	J	PM	PM	PM	PM	PM	PM		
	C	K	K	K	K	K	K								
	B	N	N	N	G	N	N								
	A	S	S	S	H	S	S								
24S + 6P		HD												HD	

PART NUMBER	ROWS	SIGNAL					POWER								
		1	2	3	4	5	P1	P2	P3	P4	P5	P6	P7	P8	
1-6450131-5	D	J	J	J	J	J	PM	PM	PM	PM	PM	PM	PM	PM	
	C	K	K	K	K	K									
	B	N	G	N	N	N									
	A	S	S	S	S	S									
20S + 8P		HD												HD	

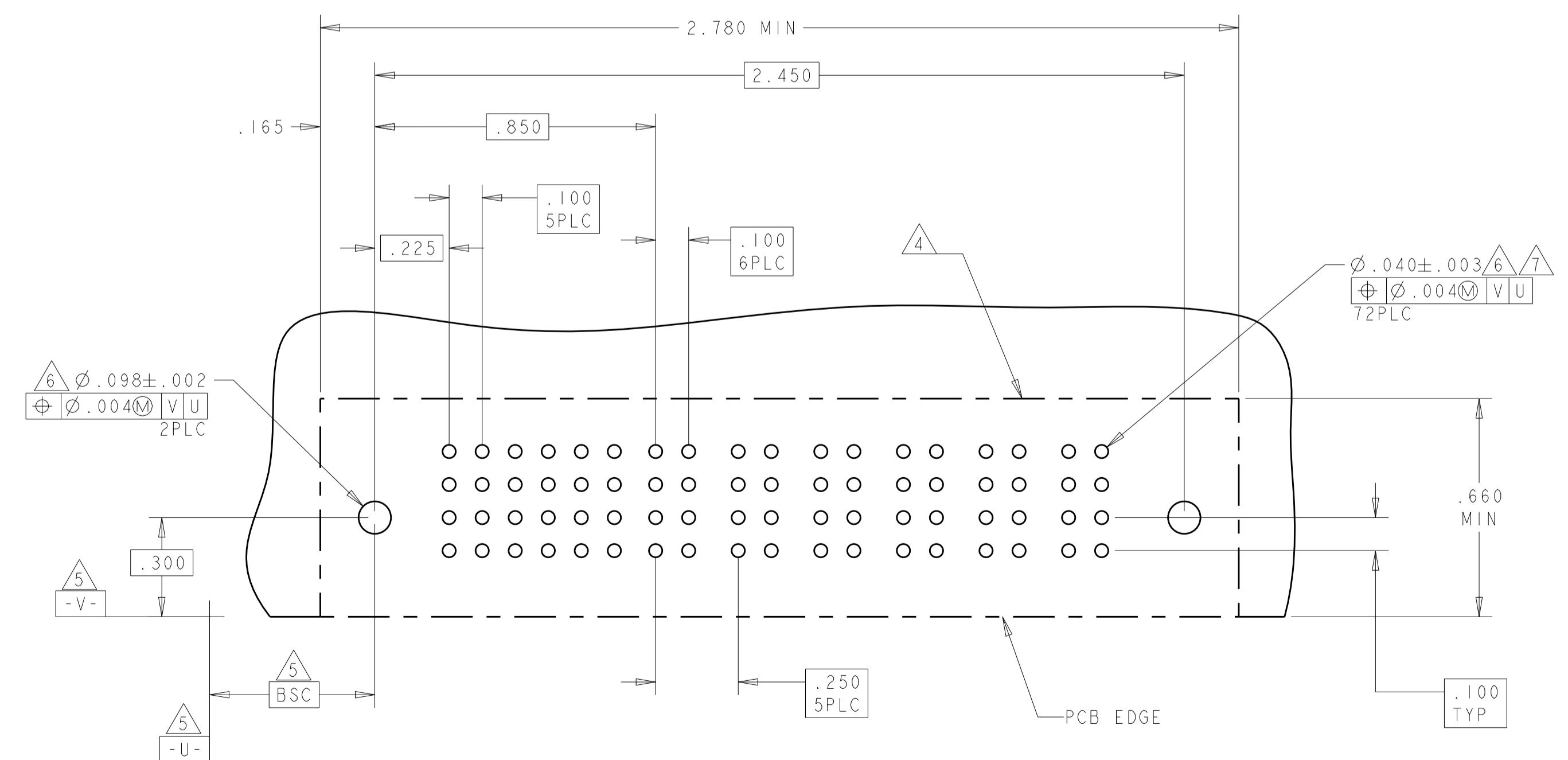
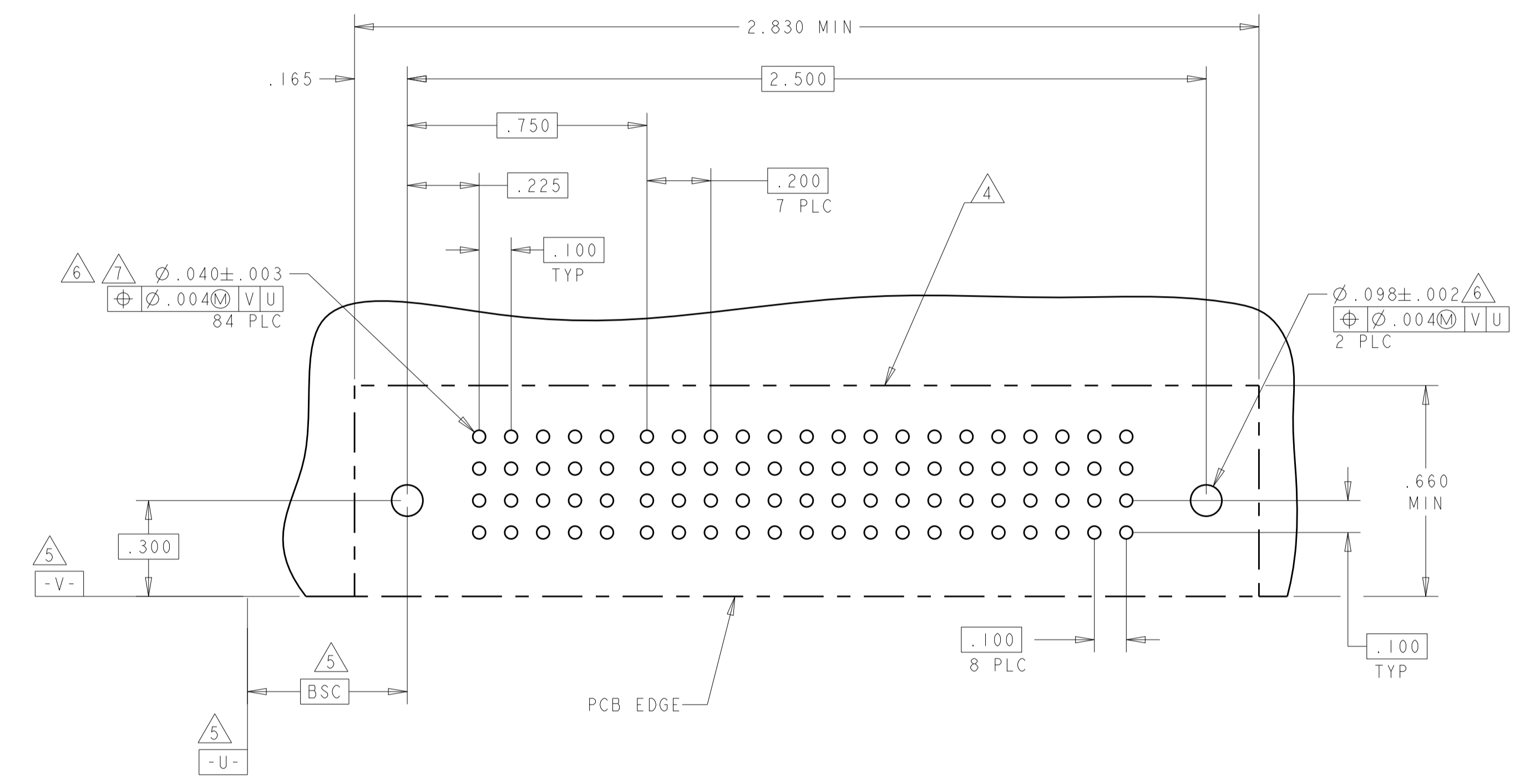
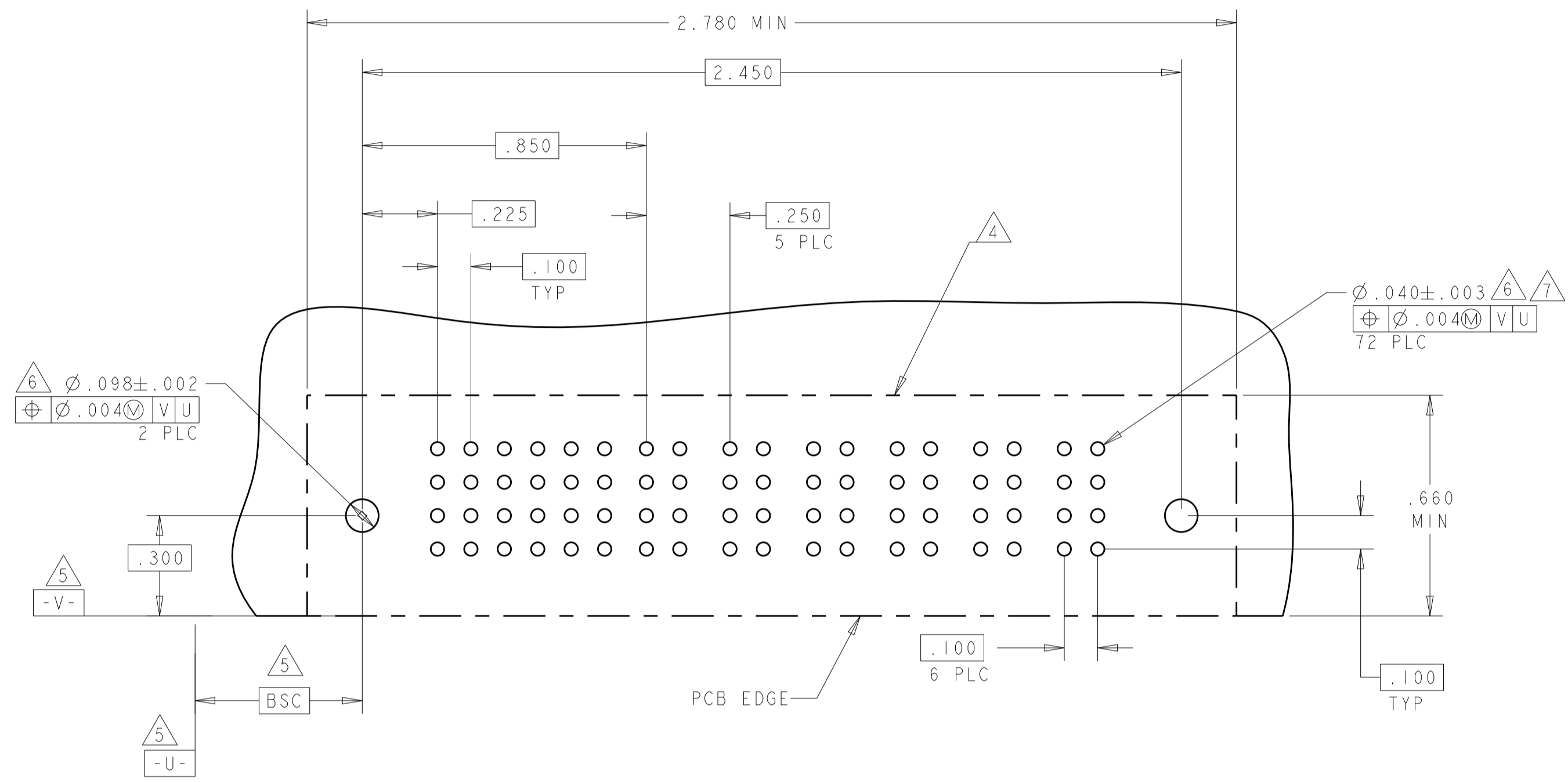

PART NUMBER	ROWS	SIGNAL						POWER							
		1	2	3	4	5	6	P1	P2	P3	P4	P5	P6		
1-6450131-6	D	J	J	J	J	J	E	PM	PM	PM	PM	PM	PM		
	C	K	K	K	K	K	K								
	B	N	N	N	N	N	N								
	A	H	S	S	S	S	S								
24S + 6P		HD												HD	

THIS DRAWING IS A CONTROLLED DOCUMENT. OWN: R. GRZYBOWSKI 15FEB05
 CHK: M. PERCHERKE 15FEB05
 APVD: M. PERCHERKE NAME: M. PERCHERKE

STE TE Connectivity

RIGHT ANGLE HEADER ASSY
 SOLDER CONTACTS, W/GUIDES
 MULTI-BEAM XL

DIMENSIONS: INCHES TOLERANCES UNLESS OTHERWISE SPECIFIED:
 0 PLC ± .010
 1 PLC ± .010
 2 PLC ± .010
 3 PLC ± .005
 4 PLC ± .002
 ANGLES ± .0020

MATERIAL: FINISH:

WEIGHT: 114-13038
 CUSTOMER DRAWING

SCALE: 1:1 SHEET 5 OF 9 REV: E9

LOC	DIST	REVISIONS			
P	LTN	DESCRIPTION	DATE	DMN	APVD
-	-	SEE SHEET 1	-	-	-

PART NUMBER	ROWS	SIGNAL						POWER									
		1	2	3	4	5	6	P1	P2	P3	P4	P5	P6	P7	P8	P9	P10
1-6450131-7	D	J	J	J	J	J	J	PM	PM	PM	PM	PM	PM	PM	PM	PM	PM
	C	K	K	K	F	K	K	PM	PM	PM	PM	PM	PM	PM	PM	PM	PM
	B	N	N	N	N	N	N	PM	PM	PM	PM	PM	PM	PM	PM	PM	PM
A	A	S	S	S	S	S	S	PM	PM	PM	PM	PM	PM	PM	PM	PM	PM
24S + 10HDP																	

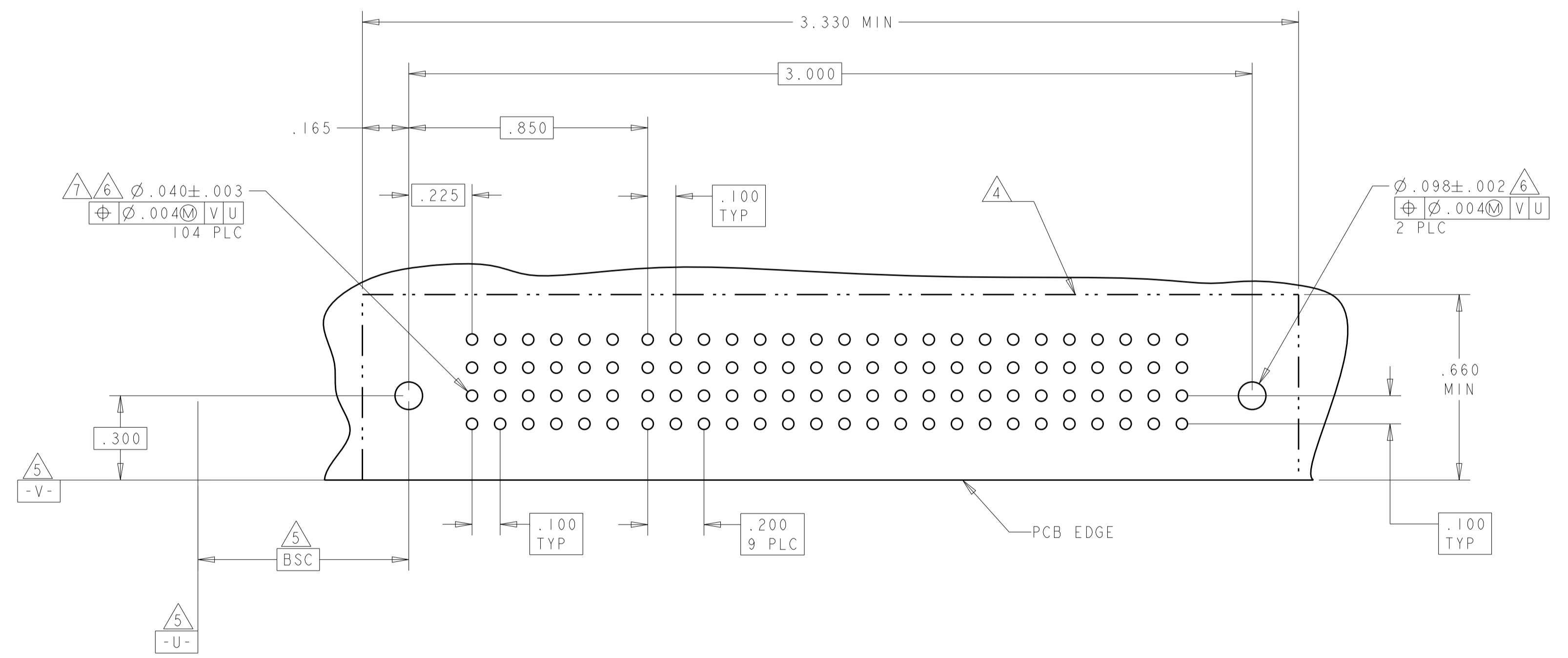

THIS DRAWING IS A CONTROLLED DOCUMENT.

DWN: R. GRZYBOWSKI	15FEB05	 TE Connectivity
CHK: M. PERCHERKE	15FEB05	
APVD: M. PERCHERKE		NAME: RIGHT ANGLE HEADER ASSY
DIMENSIONS: INCHES		PRODUCT SPEC: 108-1973
TOLERANCES UNLESS OTHERWISE SPECIFIED:		APPLICATION SPEC: 114-13038
0 PLC ±	1 PLC ±.01	SIZE: A1
2 PLC ±.01	3 PLC ±.01	CAGE CODE: 6450131
4 PLC ±.005	5 PLC ±.002	RESTRICTED TO:
6 PLC ±.0020	ANGLES: 45°	SCALE: 1:1
MATERIAL:	FINISH:	SHEET: 6 OF 9
CUSTOMER DRAWING		REV: E9

LOC	DIST	REV	DATE	BY	APPV
ES	00				

REVISIONS		DATE	BY	APPV
1	SEE SHEET 1			

PART NUMBER	ROWS	SIGNAL								POWER											
		1	2	3	4	5	6	7	8	P1	P2	P3	P4	P5	P6	P7	P8	P9	P10		
I-6450131-8	D	J	J	J	J	J	J	J	J	PM	PM	PM	PM	PM	PM	PM	PM	PM	PM		
	C	K	K	K	F	F	K	K	K												
	B	N	N	N	G	G	N	N	N												
	A	S	S	S	S	S	S	S	S												
32S + 10P		HD																		HD	

PART NUMBER	ROWS	SIGNAL			POWER				
		1	2	3	P1	P2	P3	P4	
I-6450131-9	D	J	FJ	FJ					
	C	K	K	K	PM	PM	PM	PM	
	B	N	N	N					
	A	H	H	S					
12S + 4P		HD						HD	

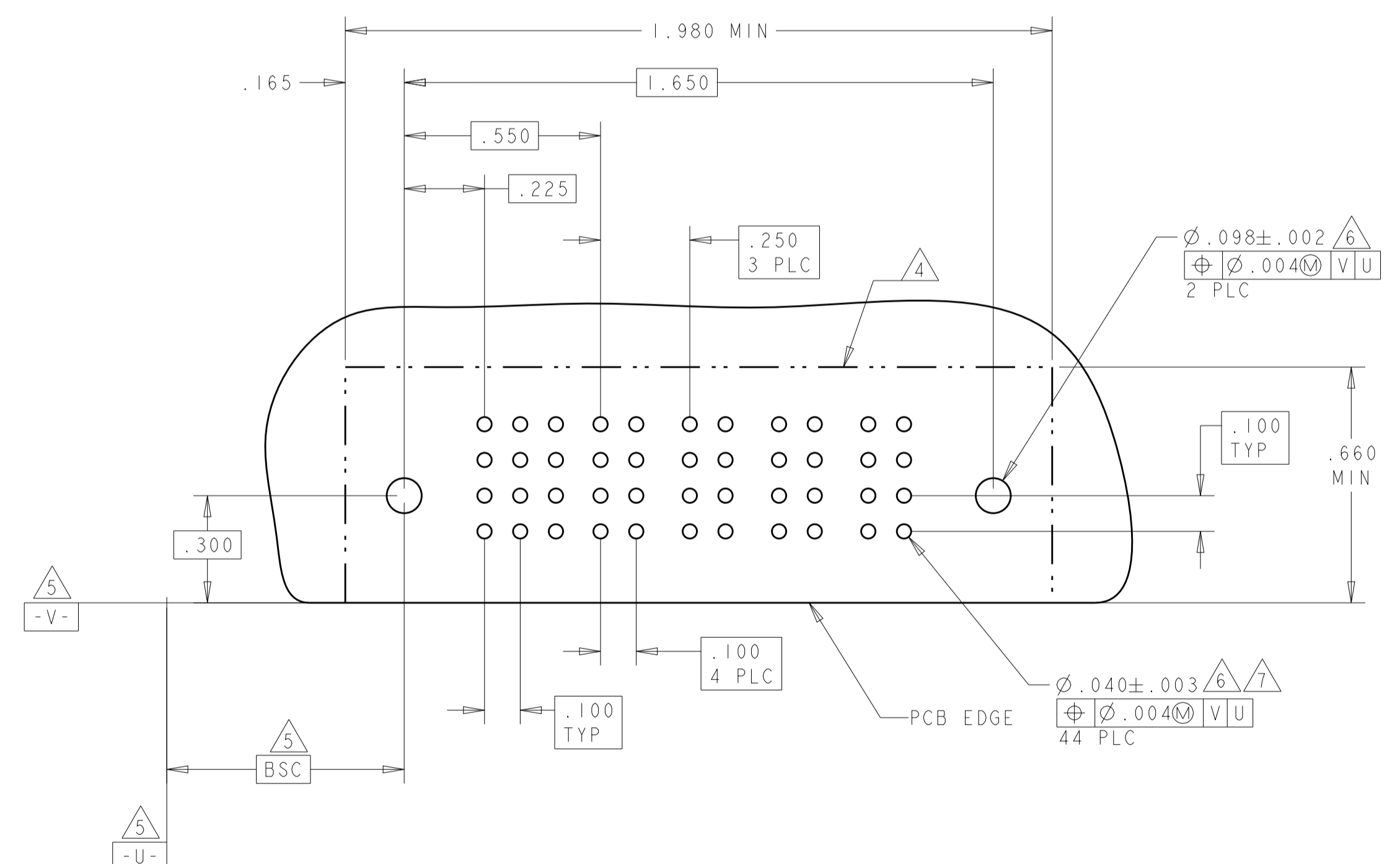
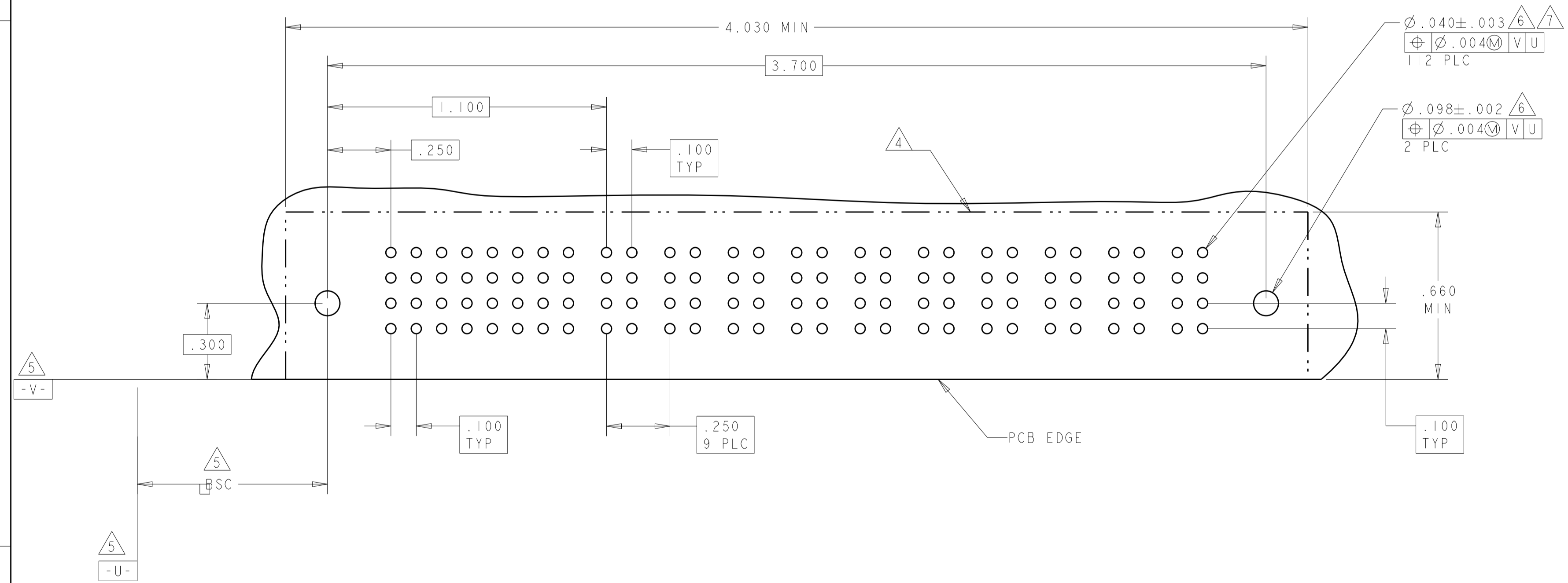

THIS DRAWING IS A CONTROLLED DOCUMENT.

DIMENSIONS:	TOLERANCES UNLESS OTHERWISE SPECIFIED:	OWN: R. GRZYBOWSKI	15FEB05
INCHES	0 PLC ± .01	CHK: M. PERCHERKE	15FEB05
	1 PLC ± .01	APVD: M. PERCHERKE	
	2 PLC ± .01	NAME: R. GRZYBOWSKI	
	3 PLC ± .005	PRODUCT SPEC: 108-1973	
	4 PLC ± .002	APPLICATION SPEC: 114-13038	
	ANGLES ± .020	SIZE: 114-13038	
MATERIAL:	FINISH:	WEIGHT:	
		CUSTOMER DRAWING	

RESTRICTED TO

SCALE: 1:1 SHEET 7 OF 9 REV: E9

LOC	DIST	REVISIONS			
P	LTN	DESCRIPTION	DATE	DMN	APVD
-	-	SEE SHEET 1	-	-	-

PART NUMBER	ROWS	POWER		SIGNAL						POWER	
		P1	P2	1	2	3	4	5	6	P3	P4
2-6450131-1	D	HD	HD	J	J	J	J	J	J	HD	HD
	C			K	K	K	K	K	F		
	B			N	N	N	N	N	N		
	A			S	S	S	S	S	S		

24S

NO CONTACT LOADED

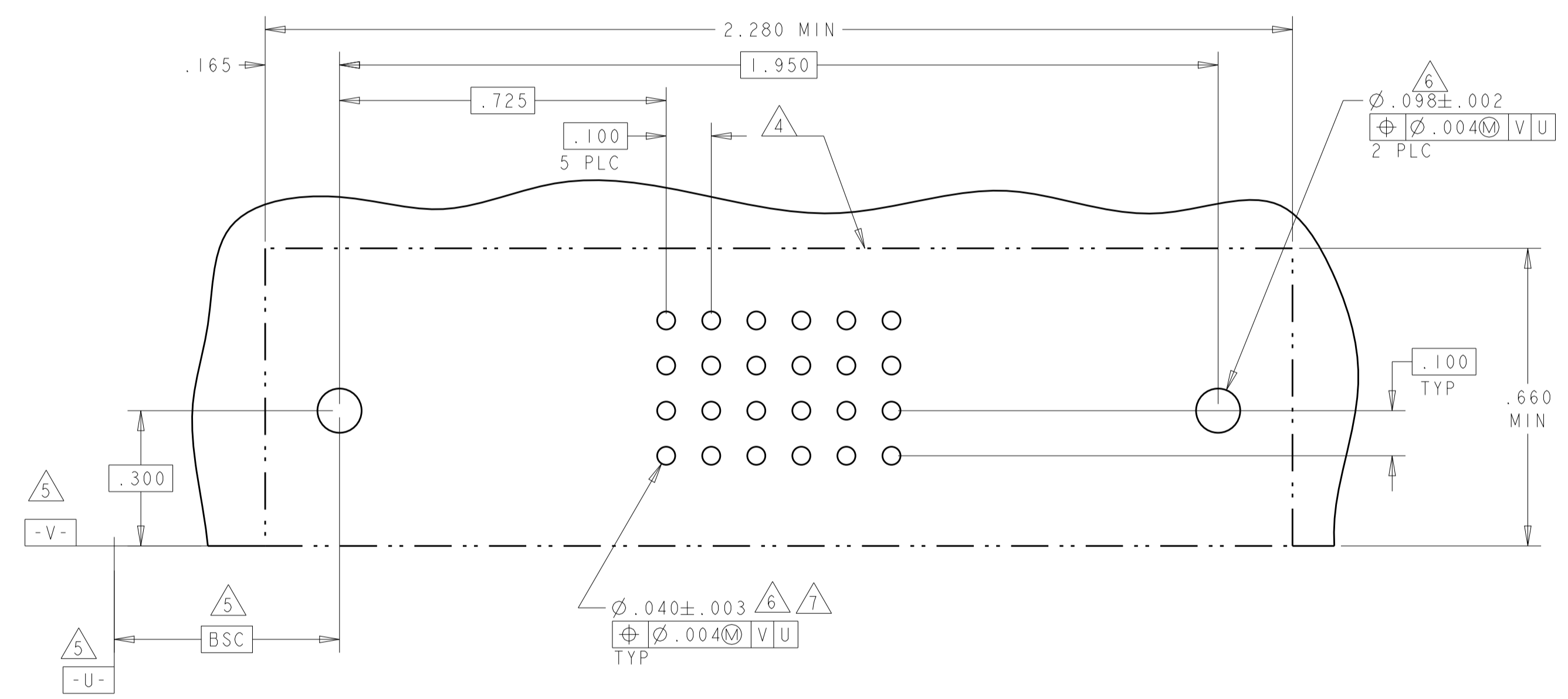

PART NUMBER	ROWS	SIGNAL				POWER			
		1	2	3	4	P1	P2	P3	P4
2-6450131-2	D	J	J	J	J	HD	HD		
	C	K	K	K	K				
	B	N	N	N	N				
	A	H	S	S	S				

16S + 4P

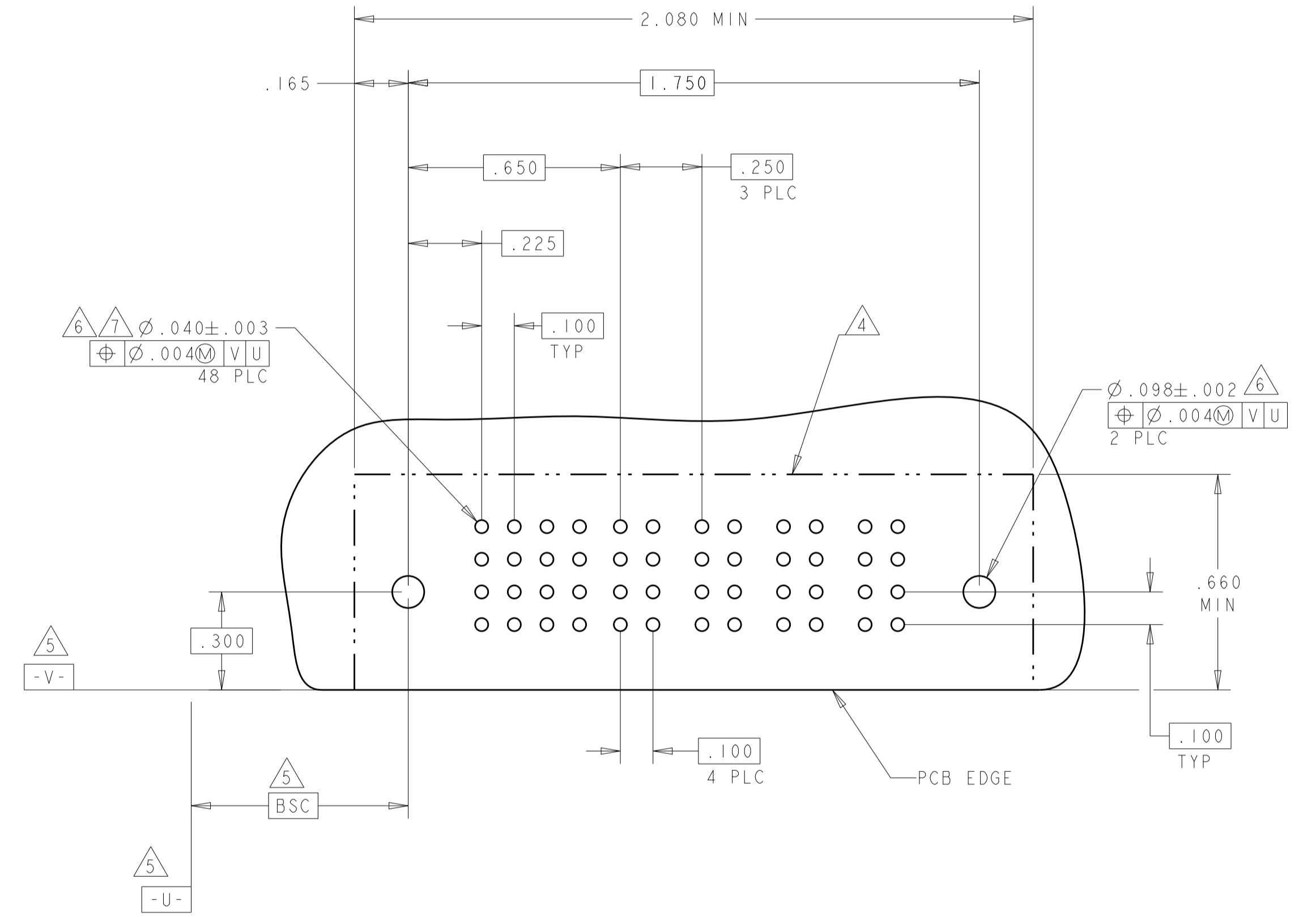

THIS DRAWING IS A CONTROLLED DOCUMENT.		DMN: R. GRZYBOWSKI 15FEB05	 TE Connectivity
DIMENSIONS: INCHES		CHK: M. PERCHERKE 15FEB05	
TOLERANCES UNLESS OTHERWISE SPECIFIED:		APVD: M. PERCHERKE	NAME: RIGHT ANGLE HEADER ASSY
0 PLC ± .01		PRODUCT SPEC: 108-1973	SOLDER CONTACTS, W/GUIDES
1 PLC ± .01		APPLICATION SPEC: 114-13038	MULTI-BEAM XL
2 PLC ± .01		SIZE: 114-13038	RESTRICTED TO:
3 PLC ± .01		WEIGHT: -	A100779C=6450131
4 PLC ± .002		CUSTOMER DRAWING	SCALE: 1:1 SHEET 8 OF 9 REV: E9
ANGLES: ± 0.2°			
FINISH: -			

LOC	DIST	REVISIONS					
ES	00	P	LTH	DESCRIPTION	DATE	DWN	APVD
		-		SEE SHEET 1			

PART NUMBER	ROWS	SIGNAL												POWER												
		1	2	3	4	5	6	7	8	9	10	11	12	13	P1	P2	P3	P4	P5	P6	P7	P8	P9	P10	P11	P12
2-6450131-3	D	J	J	J	J	J	J	J	J	J	J	J	J	J	PM	PM	PM	PM	PM	PM	PM	PM	PM	PM	PM	PM
	C	K	K	K	K	K	F	F	K	K	K	K	K													
	B	N	N	N	N	N	G	G	N	N	N	N	N													
	A	S	S	S	S	S	S	S	S	S	S	S	S													
52S + 12P		HD												HD												

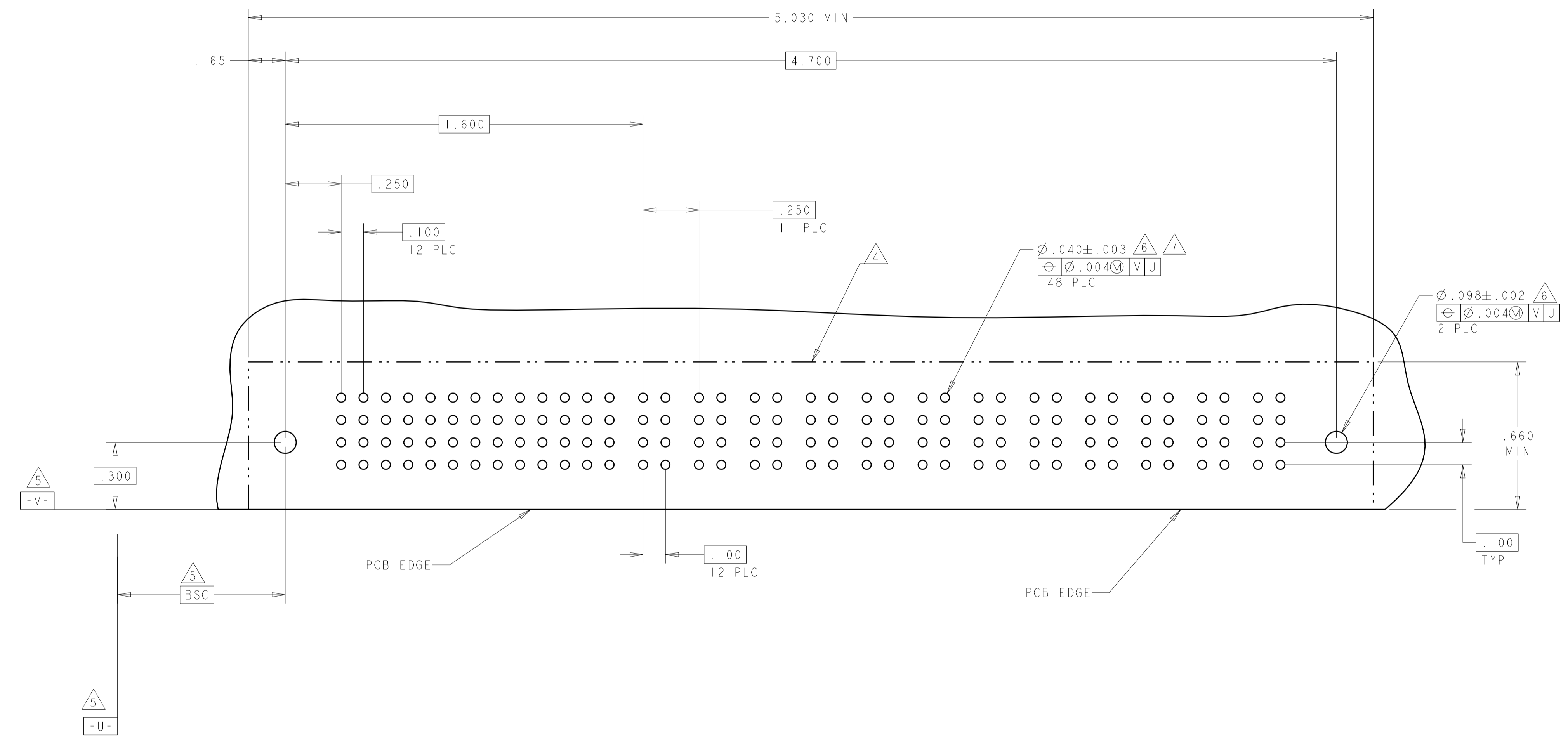

THIS DRAWING IS A CONTROLLED DOCUMENT.		DWN R. GRZYBOWSKI 15FEB05	TE Connectivity
DIMENSIONS: INCHES		CHK M. PERCHERKE 15FEB05	
TOLERANCES UNLESS OTHERWISE SPECIFIED: 0 PLC ±. 1 PLC ±.01 2 PLC ±.01 3 PLC ±.005 4 PLC ±.0020 ANGLES ±.2°		APVD M. PERCHERKE	NAME RIGHT ANGLE HEADER ASSY SOLDER CONTACTS, W/GUIDES MULTI-BEAM XL
MATERIAL		PRODUCT SPEC 108-1973	SIZE 114-13038
FINISH		APPLICATION SPEC	RESTRICTED TO
		WEIGHT	A100779C=6450131
		CUSTOMER DRAWING	SCALE 1:1 SHEET 9 OF 9 REV E 9



Компания «ЭлектроПласт» предлагает заключение долгосрочных отношений при поставках импортных электронных компонентов на взаимовыгодных условиях!

Наши преимущества:

- Оперативные поставки широкого спектра электронных компонентов отечественного и импортного производства напрямую от производителей и с крупнейших мировых складов;
- Поставка более 17-ти миллионов наименований электронных компонентов;
- Поставка сложных, дефицитных, либо снятых с производства позиций;
- Оперативные сроки поставки под заказ (от 5 рабочих дней);
- Экспресс доставка в любую точку России;
- Техническая поддержка проекта, помощь в подборе аналогов, поставка прототипов;
- Система менеджмента качества сертифицирована по Международному стандарту ISO 9001;
- Лицензия ФСБ на осуществление работ с использованием сведений, составляющих государственную тайну;
- Поставка специализированных компонентов (Xilinx, Altera, Analog Devices, Intersil, Interpoint, Microsemi, Aeroflex, Peregrine, Syfer, Eurofarad, Texas Instrument, Miteq, Cobham, E2V, MA-COM, Hittite, Mini-Circuits, General Dynamics и др.);

Помимо этого, одним из направлений компании «ЭлектроПласт» является направление «Источники питания». Мы предлагаем Вам помощь Конструкторского отдела:

- Подбор оптимального решения, техническое обоснование при выборе компонента;
- Подбор аналогов;
- Консультации по применению компонента;
- Поставка образцов и прототипов;
- Техническая поддержка проекта;
- Защита от снятия компонента с производства.



Как с нами связаться

Телефон: 8 (812) 309 58 32 (многоканальный)

Факс: 8 (812) 320-02-42

Электронная почта: org@eplast1.ru

Адрес: 198099, г. Санкт-Петербург, ул. Калинина, дом 2, корпус 4, литера А.