



PHOTOCOUPLER PS2706-1

AC INPUT RESPONSE DARLINGTON TRANSISTOR SOP MULTI PHOTOCOUPLER SERIES

–NEPOC Series–

DESCRIPTION

The PS2706-1 is an optically coupled isolator containing a GaAs light emitting diode and an NPN silicon darlington-connected phototransistor.

This is mounted in a plastic SOP (Small Out-line Package) for high density applications.

This package has shield effect to cut off ambient light.

FEATURES

- AC input response
- High current transfer ratio (CTR = 2 000% TYP.)
- High isolation voltage (BV = 3 750 Vr.m.s.)
- Small and thin (SOP) package
- High-speed switching ($t_r, t_f = 200 \mu s$ TYP.)
- Ordering number of taping product: PS2706-1F3, F4
- ★ • Safety standards
 - UL approved: File No. E72422
 - BSI approved: File No. 8219/8220
 - CSA approved: File No. CA 101391
 - DIN EN60747-5-2 (VDE0884 Part2) approved (Option)

APPLICATIONS

- Hybrid IC
- Telephone, Exchange equipment
- FA/OA equipment
- Programmable logic controllers

The information in this document is subject to change without notice. Before using this document, please confirm that this is the latest version.

PACKAGE DIMENSIONS (in millimeters)

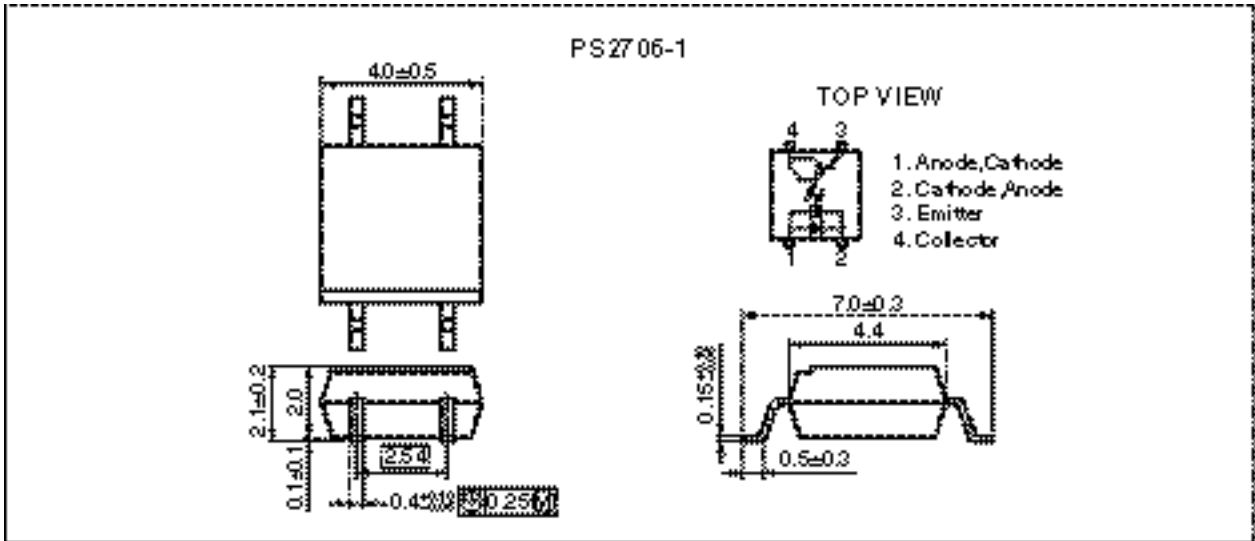

★ MARKING EXAMPLES

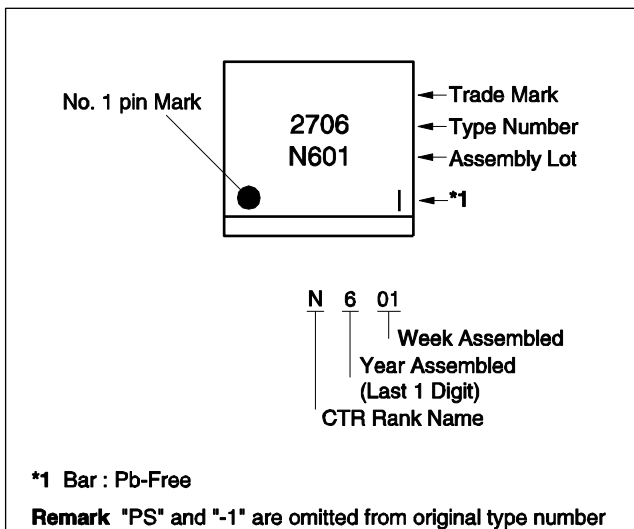

★ **ORDERING INFORMATION**

Part Number	Order Number	Solder Plating Specification	Packing Style	Safety Standard Approval	Application Part Number ^{*1}
PS2706-1	PS2706-1-A	Pb-Free	Magazine case 100 pcs	Standard products (UL, BSI, CSA approved)	PS2706-1
PS2706-1-F3	PS2706-1-F3-A		Embossed Tape 3 500 pcs/reel		
PS2706-1-F4	PS2706-1-F4-A				
PS2706-1-V	PS2706-1-V-A		Magazine case 100 pcs	DIN EN60747-5-2	
PS2706-1-V-F3	PS2706-1-V-F3-A		Embossed Tape 3 500 pcs/reel	(VDE0884 Part2)	
PS2706-1-V-F4	PS2706-1-V-F4-A			Approved (Option)	

*1 For the application of the Safety Standard, following part number should be used.

ABSOLUTE MAXIMUM RATINGS (T_A = 25°C, unless otherwise specified)

Parameter		Symbol	Ratings	Unit
Diode	Forward Current (DC)	I _F	±50	mA
	Power Dissipation Derating	ΔP _D /°C	0.8	mW/°C
	Power Dissipation	P _D	80	mW
	Peak Forward Current* ¹	I _{FP}	±1	A
Transistor	Collector to Emitter Voltage	V _{CEO}	40	V
	Emitter to Collector Voltage	V _{ECO}	6	V
	Collector Current	I _C	200	mA
	Power Dissipation Derating	ΔP _C /°C	1.5	mW/°C
	Power Dissipation	P _C	150	mW
Isolation Voltage* ²		BV	3 750	Vr.m.s.
Operating Ambient Temperature		T _A	-55 to +100	°C
Storage Temperature		T _{stg}	-55 to +150	°C

*1 PW = 100 μs, Duty Cycle = 1%

*2 AC voltage for 1 minute at T_A = 25°C, RH = 60% between input and output
Pins 1-2 shorted together, 3-4 shorted together.

ELECTRICAL CHARACTERISTICS (T_A = 25 °C)

Parameter		Symbol	Conditions	MIN.	TYP.	MAX.	Unit
Diode	Forward Voltage	V _F	I _F = ±5 mA		1.1	1.4	V
	Terminal Capacitance	C _t	V = 0 V, f = 1 MHz		60		pF
Transistor	Collector to Emitter Dark Current	I _{CEO}	I _F = 0 mA, V _{CE} = 40 V			400	nA
Coupled	Current Transfer Ratio (I _c /I _F)	CTR	I _F = ±1 mA, V _{CE} = 2 V	200	2 000		%
	CTR Ratio *1	CTR1/ CTR2	I _F = ±1 mA, V _{CE} = 2 V	0.3	1.0	3.0	
	Collector Saturation Voltage	V _{CE (sat)}	I _F = ±1 mA, I _c = 2 mA			1.0	V
	Isolation Resistance	R _{I-O}	V _{I-O} = 1 kV _{DC}	10 ¹¹			Ω
	Isolation Capacitance	C _{I-O}	V = 0 V, f = 1 MHz		0.4		pF
	Rise Time *2	t _r	V _{CC} = 5 V, I _c = 2 mA, R _L = 100 Ω		200		μs
	Fall Time *2	t _f			200		

*1 CTR1 = I_{c1}/I_{F1}, CTR2 = I_{c2}/I_{F2}

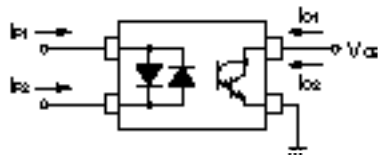

*2 Test circuit for switching time

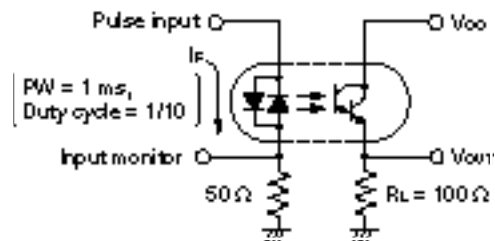

TYPICAL CHARACTERISTICS ($T_A = 25^\circ\text{C}$, unless otherwise specified)

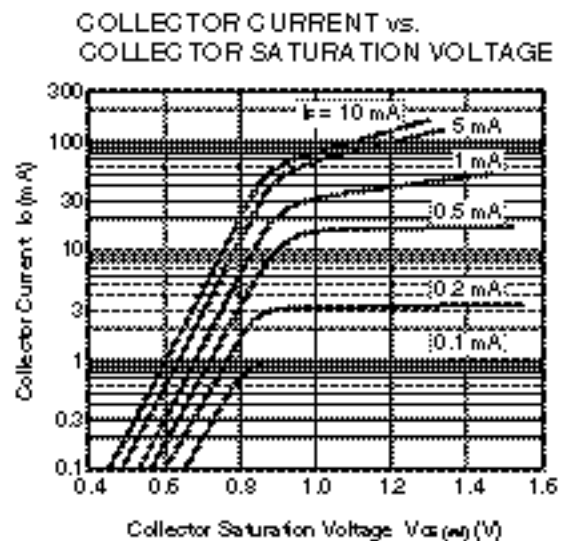
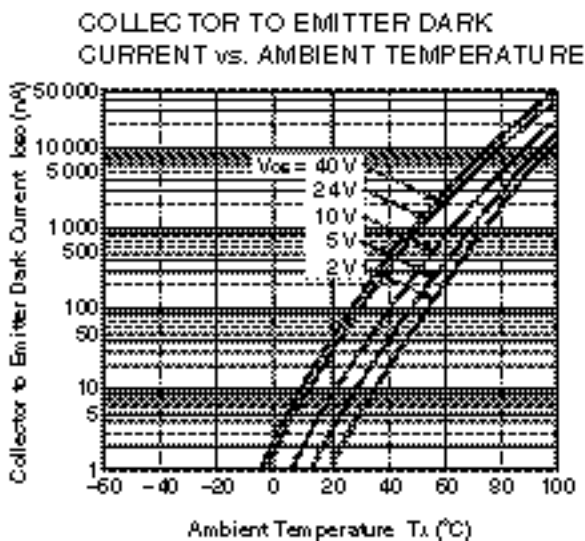
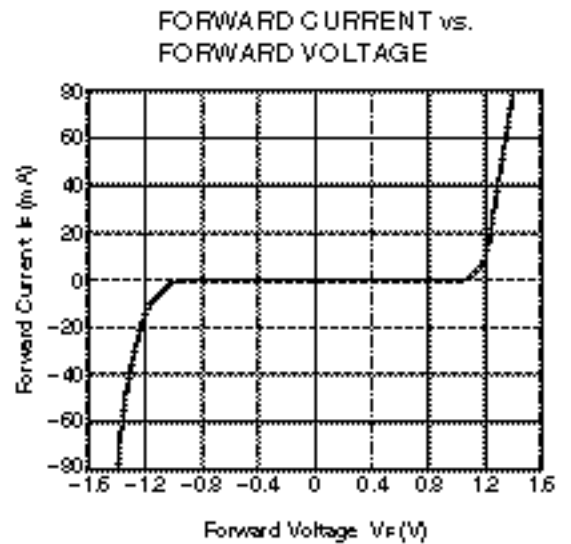
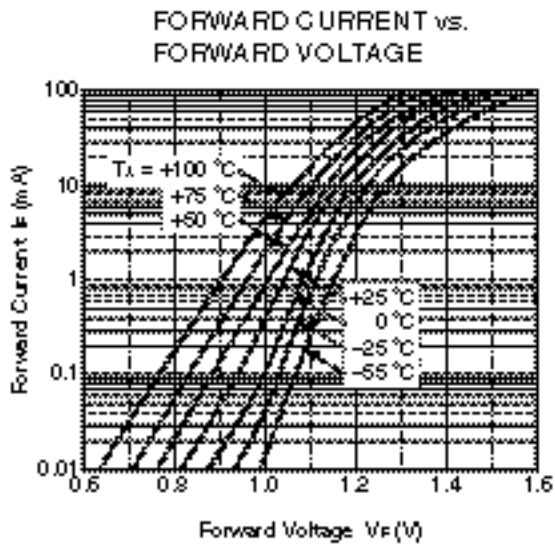
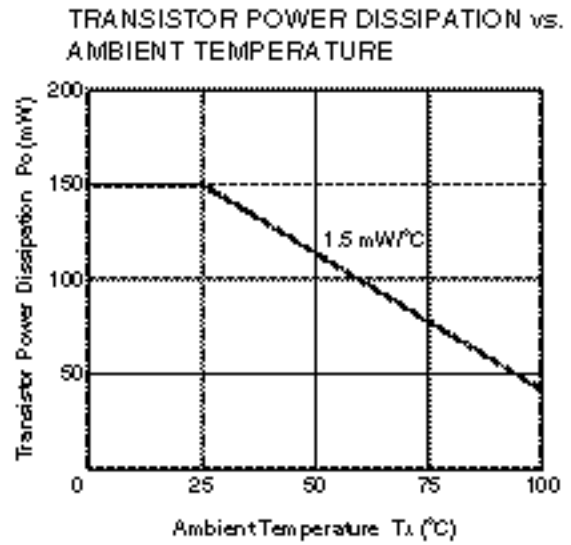
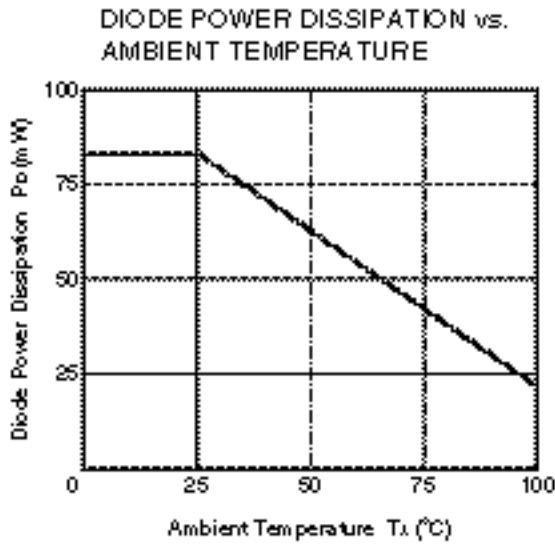

Remark The graphs indicate nominal characteristics.

COLLECTOR CURRENT vs. COLLECTOR TO EMITTER VOLTAGE

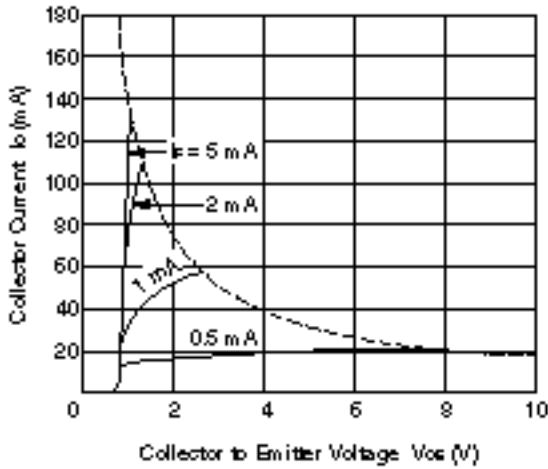

NORMALIZED CURRENT TRANSFER RATIO vs. AMBIENT TEMPERATURE

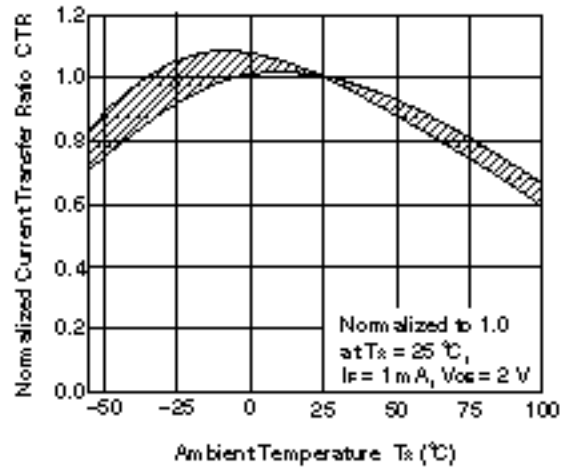

CURRENT TRANSFER RATIO vs. FORWARD CURRENT

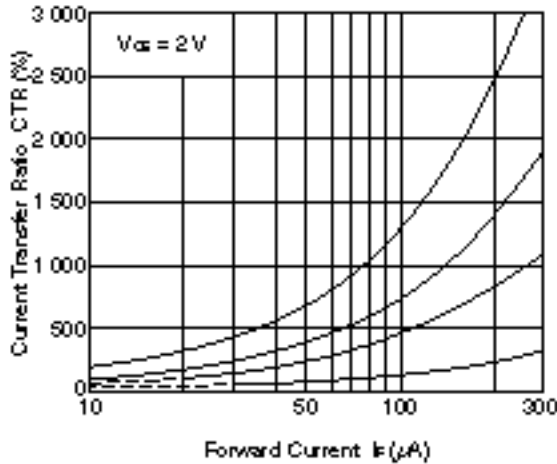

SWITCHING TIME vs. LOAD RESISTANCE

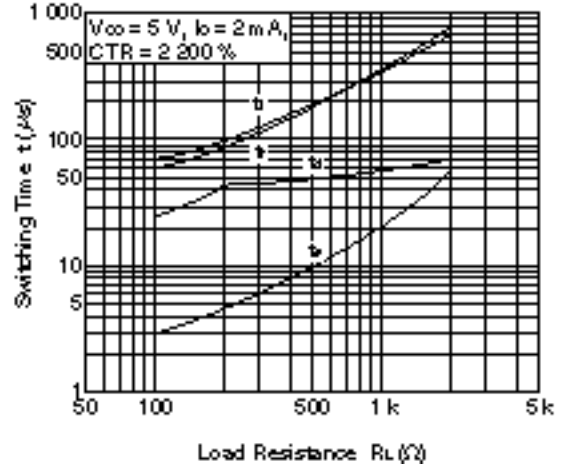

CURRENT TRANSFER RATIO vs. FORWARD CURRENT

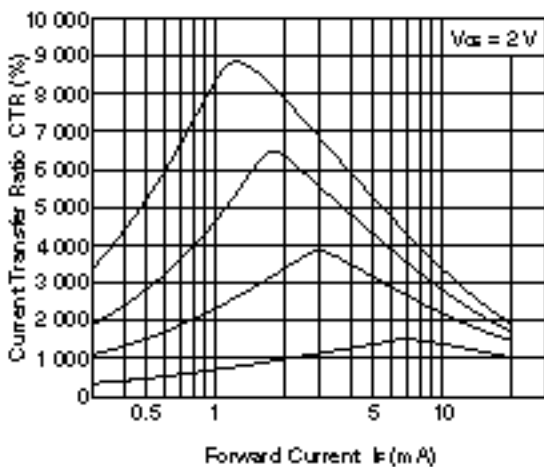

SWITCHING TIME vs. LOAD RESISTANCE

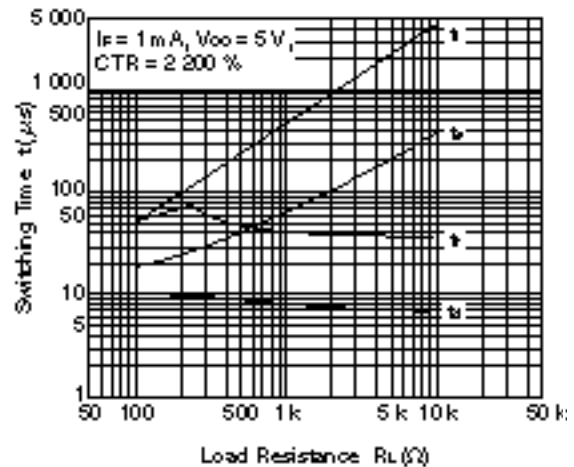

Remark The graphs indicate nominal characteristics.

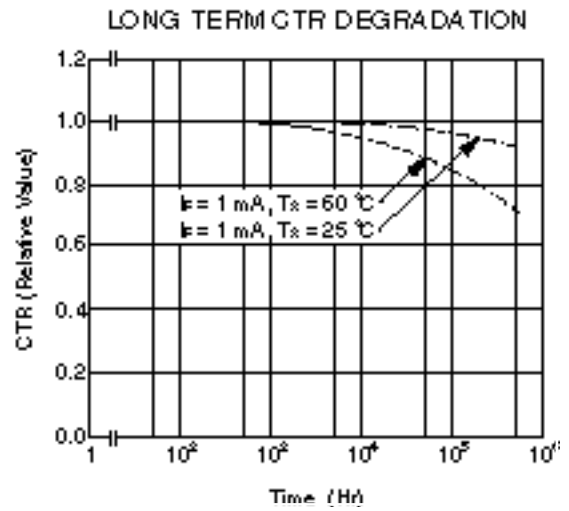
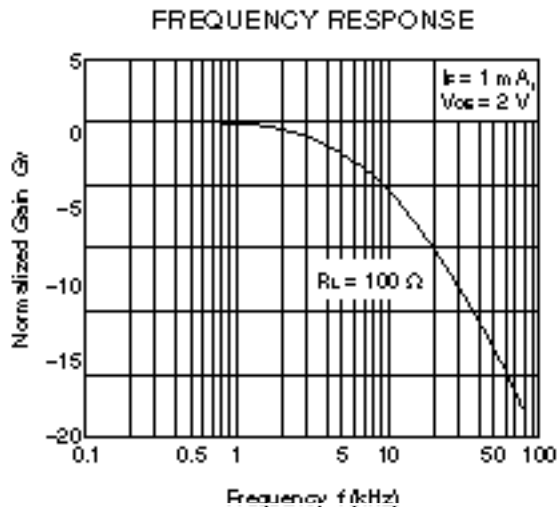

Remark The graphs indicate nominal characteristics.

TAPING SPECIFICATIONS (in millimeters)

Outline and Dimensions (Tape)

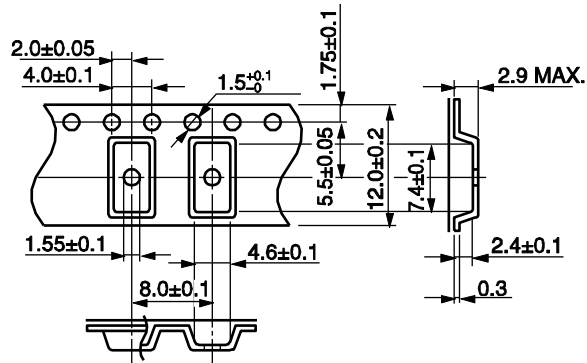

Tape Direction

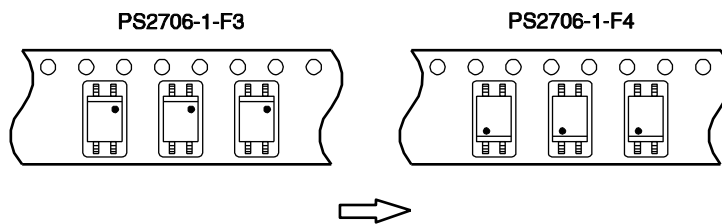

Outline and Dimensions (Reel)

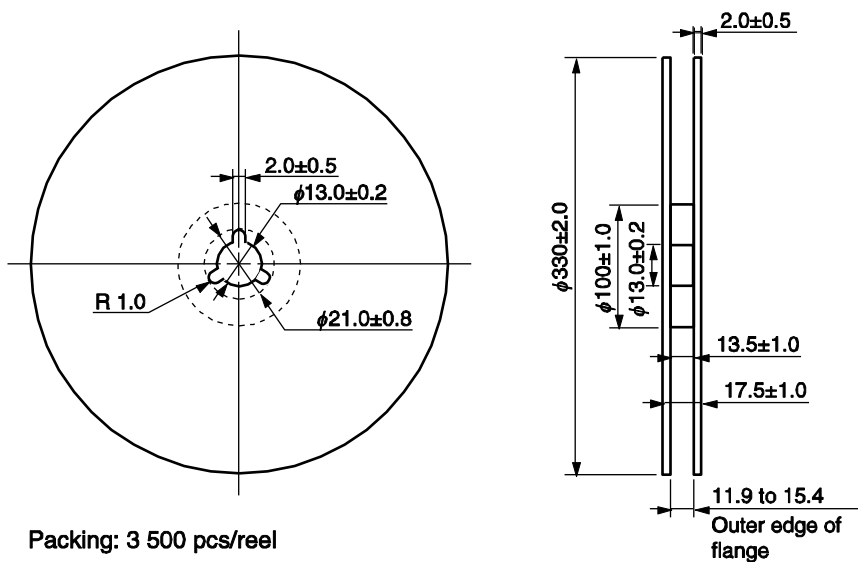

NOTES ON HANDLING

1. Recommended soldering conditions

(1) Infrared reflow soldering

- Peak reflow temperature 260°C or below (package surface temperature)
- Time of peak reflow temperature 10 seconds or less
- Time of temperature higher than 220°C 60 seconds or less
- Time to preheat temperature from 120 to 180°C 120±30 s
- Number of reflows Three
- Flux Rosin flux containing small amount of chlorine (The flux with a maximum chlorine content of 0.2 Wt% is recommended.)

Recommended Temperature Profile of Infrared Reflow

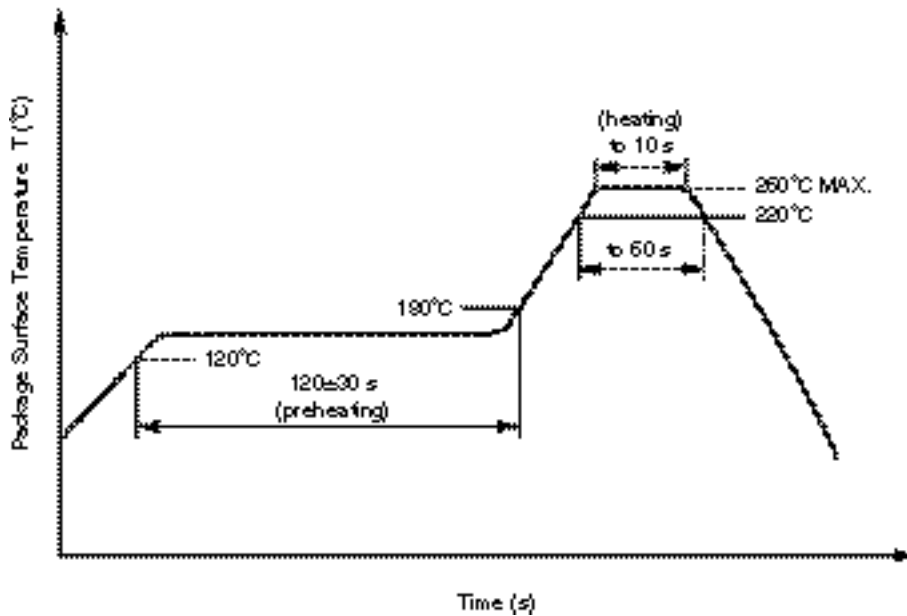

(2) Wave soldering

- Temperature 260°C or below (molten solder temperature)
- Time 10 seconds or less
- Preheating conditions 120°C or below (package surface temperature)
- Number of times One (Allowed to be dipped in solder including plastic mold portion.)
- Flux Rosin flux containing small amount of chlorine (The flux with a maximum chlorine content of 0.2 Wt% is recommended.)

★ (3) Soldering by soldering iron

- Peak temperature (lead part temperature) 350°C or below
- Time (each pins) 3 seconds or less
- Flux Rosin flux containing small amount of chlorine (The flux with a maximum chlorine content of 0.2 Wt% is recommended.)

(a) Soldering of leads should be made at the point 1.5 to 2.0 mm from the root of the lead.

(b) Please be sure that the temperature of the package would not be heated over 100°C.

(4) Cautions

• Fluxes

Avoid removing the residual flux with freon-based and chlorine-based cleaning solvent.

2. Cautions regarding noise

Be aware that when voltage is applied suddenly between the photocoupler's input and output or between collector-emitters at startup, the output transistor may enter the on state, even if the voltage is within the absolute maximum ratings.

★ 3. Measurement conditions of current transfer ratios (CTR), which differ according to photocoupler

Check the setting values before use, since the forward current conditions at CTR measurement differ according to product.

When using products other than at the specified forward current, the characteristics curves may differ from the standard curves due to CTR value variations or the like. Therefore, check the characteristics under the actual operating conditions and thoroughly take variations or the like into consideration before use.

USAGE CAUTIONS

1. Protect against static electricity when handling.
2. Avoid storage at a high temperature and high humidity.

SPECIFICATION OF VDE MARKS LICENSE DOCUMENT (VDE0884)

Parameter	Symbol	Speck	Unit
Application classification (DIN VDE 0109) for rated line voltages ≤ 300 Vr.m.s. for rated line voltages ≤ 600 Vr.m.s.		IV III	
Climatic test class (DIN IEC 68 Teil 1/09.80)		55/100/21	
Dielectric strength maximum operating isolation voltage Test voltage (partial discharge test, procedure a for type test and random test) $U_{pr} = 1.2 \times U_{IORM}, P_d < 5$ pC	U_{IORM} U_{pr}	710 850	V_{peak} V_{peak}
Test voltage (partial discharge test, procedure b for all devices test) $U_{pr} = 1.6 \times U_{IORM}, P_d < 5$ pC	U_{pr}	1 140	V_{peak}
Highest permissible overvoltage	U_{TR}	6 000	V_{peak}
Degree of pollution (DIN VDE 0109)		2	
Clearance distance		> 5	mm
Creepage distance		> 5	mm
Comparative tracking index (DIN IEC 112/VDE 0303 part 1)	CTI	175	
Material group (DIN VDE 0109)		III a	
Storage temperature range	T_{stg}	-55 to +150	°C
Operating temperature range	T_A	-55 to +100	°C
Isolation resistance, minimum value $V_{IO} = 500$ V dc at $T_A = 25$ °C $V_{IO} = 500$ V dc at T_A MAX. at least 100 °C	Ris MIN. Ris MIN.	10^{12} 10^{11}	Ω Ω
Safety maximum ratings (maximum permissible in case of fault, see thermal derating curve) Package temperature Current (input current $I_F, P_{si} = 0$) Power (output or total power dissipation) Isolation resistance $V_{IO} = 500$ V dc at $T_A = 175$ °C (T_{si})	T_{si} I_{si} P_{si} Ris MIN.	150 200 300 10^9	°C mA mW Ω

When the product(s) listed in this document is subject to any applicable import or export control laws and regulation of the authority having competent jurisdiction, such product(s) shall not be imported or exported without obtaining the import or export license.

- **The information in this document is current as of March, 2006. The information is subject to change without notice. For actual design-in, refer to the latest publications of NEC's data sheets or data books, etc., for the most up-to-date specifications of NEC semiconductor products. Not all products and/or types are available in every country. Please check with an NEC sales representative for availability and additional information.**
- No part of this document may be copied or reproduced in any form or by any means without prior written consent of NEC. NEC assumes no responsibility for any errors that may appear in this document.
- NEC does not assume any liability for infringement of patents, copyrights or other intellectual property rights of third parties by or arising from the use of NEC semiconductor products listed in this document or any other liability arising from the use of such products. No license, express, implied or otherwise, is granted under any patents, copyrights or other intellectual property rights of NEC or others.
- Descriptions of circuits, software and other related information in this document are provided for illustrative purposes in semiconductor product operation and application examples. The incorporation of these circuits, software and information in the design of customer's equipment shall be done under the full responsibility of customer. NEC assumes no responsibility for any losses incurred by customers or third parties arising from the use of these circuits, software and information.
- While NEC endeavours to enhance the quality, reliability and safety of NEC semiconductor products, customers agree and acknowledge that the possibility of defects thereof cannot be eliminated entirely. To minimize risks of damage to property or injury (including death) to persons arising from defects in NEC semiconductor products, customers must incorporate sufficient safety measures in their design, such as redundancy, fire-containment, and anti-failure features.
- NEC semiconductor products are classified into the following three quality grades:
 "Standard", "Special" and "Specific". The "Specific" quality grade applies only to semiconductor products developed based on a customer-designated "quality assurance program" for a specific application. The recommended applications of a semiconductor product depend on its quality grade, as indicated below. Customers must check the quality grade of each semiconductor product before using it in a particular application.
 "Standard":•Computers, office equipment, communications equipment, test and measurement equipment, audio
 •• and visual equipment, home electronic appliances, machine tools, personal electronic equipment
 •• and industrial robots
 "Special":• Transportation equipment (automobiles, trains, ships, etc.), traffic control systems, anti-disaster
 •• systems, anti-crime systems, safety equipment and medical equipment (not specifically designed
 •• for life support)
 "Specific":• Aircraft, aerospace equipment, submersible repeaters, nuclear reactor control systems, life
 •• support systems and medical equipment for life support, etc.
 The quality grade of NEC semiconductor products is "Standard" unless otherwise expressly specified in NEC's data sheets or data books, etc. If customers wish to use NEC semiconductor products in applications not intended by NEC, they must contact an NEC sales representative in advance to determine NEC's willingness to support a given application.
 (Note)
 (1)•"NEC" as used in this statement means NEC Corporation, NEC Compound Semiconductor Devices, Ltd.
 •• and also includes its majority-owned subsidiaries.
 (2)•"NEC semiconductor products" means any semiconductor product developed or manufactured by or for
 •• NEC (as defined above).

M8E 00.4-0110

<p>Caution</p>	<p>GaAs Products</p>	<p>This product uses gallium arsenide (GaAs). GaAs vapor and powder are hazardous to human health if inhaled or ingested, so please observe the following points.</p> <ul style="list-style-type: none"> • Follow related laws and ordinances when disposing of the product. If there are no applicable laws and/or ordinances, dispose of the product as recommended below. <ol style="list-style-type: none"> 1. Commission a disposal company able to (with a license to) collect, transport and dispose of materials that contain arsenic and other such industrial waste materials. 2. Exclude the product from general industrial waste and household garbage, and ensure that the product is controlled (as industrial waste subject to special control) up until final disposal. • Do not burn, destroy, cut, crush, or chemically dissolve the product. • Do not lick the product or in any way allow it to enter the mouth.
-----------------------	----------------------	---

► **For further information, please contact**

NEC Compound Semiconductor Devices, Ltd. <http://www.ncsd.necel.com/>

E-mail: salesinfo@ml.ncsd.necel.com (sales and general)

techinfo@ml.ncsd.necel.com (technical)

Sales Division TEL: +81-44-435-1573 FAX: +81-44-435-1579

NEC Compound Semiconductor Devices Hong Kong Limited

E-mail: ncsd-hk@elhk.nec.com.hk (sales, technical and general)

Hong Kong Head Office TEL: +852-3107-7303 FAX: +852-3107-7309

Taipei Branch Office TEL: +886-2-8712-0478 FAX: +886-2-2545-3859

Korea Branch Office TEL: +82-2-558-2120 FAX: +82-2-558-5209

NEC Electronics (Europe) GmbH <http://www.ee.nec.de/>

TEL: +49-211-6503-0 FAX: +49-211-6503-1327

California Eastern Laboratories, Inc. <http://www.cel.com/>

TEL: +1-408-988-3500 FAX: +1-408-988-0279



Компания «ЭлектроПласт» предлагает заключение долгосрочных отношений при поставках импортных электронных компонентов на взаимовыгодных условиях!

Наши преимущества:

- Оперативные поставки широкого спектра электронных компонентов отечественного и импортного производства напрямую от производителей и с крупнейших мировых складов;
- Поставка более 17-ти миллионов наименований электронных компонентов;
- Поставка сложных, дефицитных, либо снятых с производства позиций;
- Оперативные сроки поставки под заказ (от 5 рабочих дней);
- Экспресс доставка в любую точку России;
- Техническая поддержка проекта, помощь в подборе аналогов, поставка прототипов;
- Система менеджмента качества сертифицирована по Международному стандарту ISO 9001;
- Лицензия ФСБ на осуществление работ с использованием сведений, составляющих государственную тайну;
- Поставка специализированных компонентов (Xilinx, Altera, Analog Devices, Intersil, Interpoint, Microsemi, Aeroflex, Peregrine, Syfer, Eurofarad, Texas Instrument, Miteq, Cobham, E2V, MA-COM, Hittite, Mini-Circuits, General Dynamics и др.);

Помимо этого, одним из направлений компании «ЭлектроПласт» является направление «Источники питания». Мы предлагаем Вам помощь Конструкторского отдела:

- Подбор оптимального решения, техническое обоснование при выборе компонента;
- Подбор аналогов;
- Консультации по применению компонента;
- Поставка образцов и прототипов;
- Техническая поддержка проекта;
- Защита от снятия компонента с производства.



Как с нами связаться

Телефон: 8 (812) 309 58 32 (многоканальный)

Факс: 8 (812) 320-02-42

Электронная почта: org@eplast1.ru

Адрес: 198099, г. Санкт-Петербург, ул. Калинина, дом 2, корпус 4, литера А.