

AN-REF-10W ADAPTER

10W 5V Adapter Reference Board
with ICE2QS03G & IPU60R950C6

AN-PS0080

Application Note AN-REF-10W ADAPTER
V1.1, 2014-02-20

Edition 2014-02-20

**Published by Infineon Technologies AG,
81726 Munich, Germany.**

© 2014 Infineon Technologies AG

All Rights Reserved.

LEGAL DISCLAIMER

THE INFORMATION GIVEN IN THIS APPLICATION NOTE IS GIVEN AS A HINT FOR THE IMPLEMENTATION OF THE INFINEON TECHNOLOGIES COMPONENT ONLY AND SHALL NOT BE REGARDED AS ANY DESCRIPTION OR WARRANTY OF A CERTAIN FUNCTIONALITY, CONDITION OR QUALITY OF THE INFINEON TECHNOLOGIES COMPONENT. THE RECIPIENT OF THIS APPLICATION NOTE MUST VERIFY ANY FUNCTION DESCRIBED HEREIN IN THE REAL APPLICATION. INFINEON TECHNOLOGIES HEREBY DISCLAIMS ANY AND ALL WARRANTIES AND LIABILITIES OF ANY KIND (INCLUDING WITHOUT LIMITATION WARRANTIES OF NON-INFRINGEMENT OF INTELLECTUAL PROPERTY RIGHTS OF ANY THIRD PARTY) WITH RESPECT TO ANY AND ALL INFORMATION GIVEN IN THIS APPLICATION NOTE.

Information

For further information on technology, delivery terms and conditions and prices, please contact the nearest Infineon Technologies Office (www.infineon.com).

Warnings

Due to technical requirements, components may contain dangerous substances. For information on the types in question, please contact the nearest Infineon Technologies Office.

Infineon Technologies components may be used in life-support devices or systems only with the express written approval of Infineon Technologies, if a failure of such components can reasonably be expected to cause the failure of that life-support device or system or to affect the safety or effectiveness of that device or system. Life support devices or systems are intended to be implanted in the human body or to support and/or maintain and sustain and/or protect human life. If they fail, it is reasonable to assume that the health of the user or other persons may be endangered.

Trademarks of Infineon Technologies AG

AURIX™, C6 6™, CanPAK™, CIPOST™, CIPURSE™, EconoPACK™, CoolMOS™, CoolSET™, CORECONTROL™, CROSSAVE™, DAVE™, DI-POL™, EasyPIM™, EconoBRIDGE™, EconoDUAL™, EconoPIM™, EconoPACK™, EiceDRIVER™, eupec™, FCOS™, HITFET™, HybridPACK™, I²RF™, ISOFACE™, IsoPACK™, MIPAQ™, ModSTACK™, my-d™, NovalithIC™, OptiMOS™, ORIGA™, POWERCODE™, PRIMARION™, PrimePACK™, PrimeSTACK™, PRO-SIL™, PROFET™, RASIC™, ReverSave™, SatRIC™, SIEGET™, SINDRION™, SIPMOS™, SmartLEWIS™, SOLID FLASH™, TEMPFET™, thinQ!™, TRENCHSTOP™, TriCore™.

Other Trademarks

Advance Design System™ (ADS) of Agilent Technologies, AMBA™, ARM™, MULTI-ICE™, KEIL™, PRIMECELL™, REALVIEW™, THUMB™, μVision™ of ARM Limited, UK. AUTOSAR™ is licensed by AUTOSAR development partnership. Bluetooth™ of Bluetooth SIG Inc. CAT-ig™ of DECT Forum. COLOSSUS™, FirstGPS™ of Trimble Navigation Ltd. EMV™ of EMVCo, LLC (Visa Holdings Inc.). EPCOS™ of Epcos AG. FLEXGO™ of Microsoft Corporation. FlexRay™ is licensed by FlexRay Consortium. HYPERTERMINAL™ of Hilgraeve Incorporated. IEC™ of Commission Electrotechnique Internationale. IrDA™ of Infrared Data Association Corporation. ISO™ of INTERNATIONAL ORGANIZATION FOR STANDARDIZATION. MATLAB™ of MathWorks, Inc. MAXIM™ of Maxim Integrated Products, Inc. MICROTEC™, NUCLEUS™ of Mentor Graphics Corporation. MIPI™ of MIPI Alliance, Inc. MIPS™ of MIPS Technologies, Inc., USA. muRata™ of MURATA MANUFACTURING CO., MICROWAVE OFFICE™ (MWO) of Applied Wave Research Inc., OmniVision™ of OmniVision Technologies, Inc. Openwave™ Openwave Systems Inc. RED HAT™ Red Hat, Inc. RFMD™ RF Micro Devices, Inc. SIRIUS™ of Sirius Satellite Radio Inc. SOLARIS™ of Sun Microsystems, Inc. SPANSION™ of Spansion LLC Ltd. Symbian™ of Symbian Software Limited. TAIYO YUDEN™ of Taiyo Yuden Co. TEAKLITE™ of CEVA, Inc. TEKTRONIX™ of Tektronix Inc. TOKO™ of TOKO KABUSHIKI KAISHA TA. UNIX™ of X/Open Company Limited. VERILOG™, PALLADIUM™ of Cadence Design Systems, Inc. VLYNQ™ of Texas Instruments Incorporated. VXWORKS™, WIND RIVER™ of WIND RIVER SYSTEMS, INC. ZETEX™ of Diodes Zetex Limited.

Last Trademarks Update 2011-11-11

Revision History

Major changes since previous revision

Date	Version	Changed By	Change Description
20 Feb 2014	1.1	Kyaw Zin Min	Update to new format

We Listen to Your Comments

Is there any information in this document that you feel is wrong, unclear or missing? Your feedback will help us to continuously improve the quality of our documentation. Please send your proposal (including a reference to this document title/number) to:

ctdd@infineon.com



Table of Contents

Revision History	4
Table of Contents	5
1 Abstract.....	7
2 Evaluation Board Photos	7
3 List of Features of ICE2QS03G	8
4 Technical Specifications for Reference Board	8
5 Circuit Description	9
5.1 Mains Input Rectification and Filtering	9
5.2 PWM Control and switching MOSFET	9
5.3 Snubber Network	9
5.4 Output Stage	9
5.5 Feedback Loop	9
6 Circuit Operation.....	10
6.1 Startup Operation.....	10
6.2 Normal Mode Operation.....	10
6.3 Primary side peak current control	10
6.4 Digital Frequency Reduction	10
6.5 Burst Mode Operation	10
7 Protection Features	11
7.1 VCC over voltage and under voltage protection	11
7.2 Foldback point protection.....	11
7.3 Over load/Open loop protection	11
7.4 Adjustable output overvoltage protection.....	11
7.5 Short winding protection.....	11
7.6 Auto restart for over temperature protection	11
8 Circuit diagram.....	12
8.1 1 st PCB artwork (top).....	13
8.2 2 nd PCB artwork (bottom).....	13
9 Component List.....	14
10 Transformer Construction.....	15
11 Test Results	16
11.1 Efficiency	16
11.2 Input standby power	16
11.3 Line regulation.....	17
11.4 Load regulation	17
11.5 Maximum input power between low and high line	17
11.6 EMI test results	18
12 Waveforms and Scope Plots.....	19
12.1 Startup at Full Load.....	19
12.2 Drain and V_{CS} voltage at maximum load.....	19
12.3 Zero Crossing Point during Normal Operation.....	20
12.4 Load Transient Response	20



12.5	Burst Mode Operation	21
12.6	Protection Mode	21
13	References	22

1 Abstract

This application note is an engineering report of a very small form factor reference design for universal input 10.5W 5V USB adapter. The adapter is using IFX **ICE2QS03G**, a second generation current mode control quasi-resonant flyback topology controller and IFX **IPU60R950C6**, a sixth generation of high voltage power CoolMOS™. The distinguishing features of this reference design are very small form factor, best in class low standby power, high efficiency, good EMI performance without using input common mode choke, very tight maximum input power control between low and high line and various modes of protection for high reliable system.

2 Evaluation Board Photos

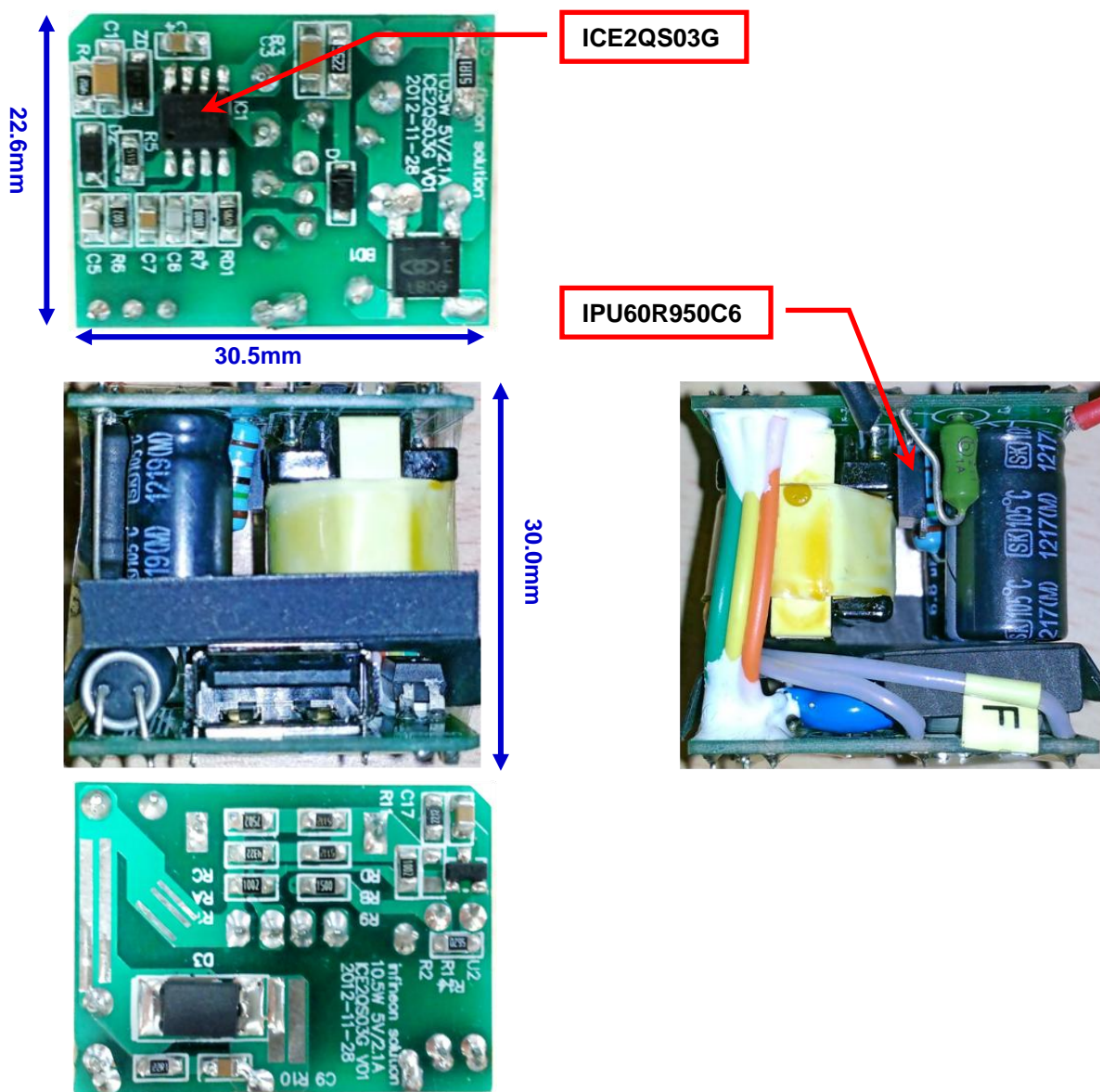

Figure 1 – REF-ICE2QS03G & IPU60R950C6 10W ADAPTER (Dimensions LxWxH: 30.5x22.6x30 mm³)

This document contains the list of features, the power supply specification, schematic, bill of material and the transformer construction documentation. Typical operating characteristics such as performance curve and scope waveforms are showed at the rear of the report.

3 List of Features of ICE2QS03G

Quasi resonant operation till very low load
Active burst mode operation at light/no load for low standby input power (< 50mW)
Digital frequency reduction with decreasing load
HV startup cell with constant charging current
Built-in digital soft-start
Foldback correction and cycle-by-cycle peak current limitation
Auto restart mode for VCC Overvoltage protection
Auto restart mode for VCC Undervoltage protection
Auto restart mode for openloop/overload protection
Auto restart mode for Over temperature protection
Latch-off mode for adjustable output overvoltage protection

4 Technical Specifications for Reference Board

Input voltage	90Vac~264Vac
Input frequency	50/60Hz
Input Standby Power	< 50mW @ no load
Maximum input power(Peak Power) for full input range	< $\pm 5\%$ of input power
Output voltage	5V
Output current	2.1A
Output power	10.5W
Active mode average efficiency(25%,50%,75% & 100%load)	>78% at full load
Minimum switching frequency at full load and minimum input voltage	40kHz

5 Circuit Description

5.1 Mains Input Rectification and Filtering

The AC line input side comprises the input fuse F1 as overcurrent protection. A rectified DC voltage (127V ~ 373V) is obtained through a bridge rectifier BR1 and a pi filter C1, L1, R13 and C2. The pi filter also attenuates the differential mode conducted EMI.

5.2 PWM Control and switching MOSFET

The PWM pulse is generated by the Quasi Resonant PWM current-mode Controller **ICE2QS03G** and this PWM pulse drives the high power CoolMOS™, **IPU60R950C6 (C6)** which designed according to the revolutionary Superjunction (SJ) principle. The CoolMOS™ C6 provides all benefits of a fast switching SJ MOSFET while not sacrificing ease of use. It achieves extremely low conduction and switching losses and can make switching applications more efficient, more compact, lighter and cooler. The PWM switch-on is determined by the zero-crossing input signal and the value of the up/down counter. The PWM switch-off is determined by the feedback signal VFB and the current sensing signal VCS. **ICE2QS03G** also performs all necessary protection functions in flyback converters. Details about the information mentioned above are illustrated in the product datasheet.

5.3 Snubber Network

A snubber network R3, C3 and D1 dissipate the energy of the leakage inductance and suppress ringing on the SMPS transformer. Due to the resonant capacitor (MOSFET's drain source capacitance), the overshoot is relatively smaller than fixed frequency flyback converter. Thus the snubber resistor can be used with a larger one which will reduce the snubber loss.

5.4 Output Stage

On the secondary side, 5V output, the power is coupled out via a schottky diode D3. The capacitors C8 and C10 provide energy buffering to reduce the output ripple and prevent interference between SMPS switching frequency and line frequency considerably. Storage capacitors C8 and C10 are designed to have an internal resistance (ESR) as small as possible. This is to minimize the output voltage ripple caused by the triangular current.

5.5 Feedback Loop

For feedback, the output is sensed by the voltage divider of R1, R2 and R12 and compared to TL431 internal reference voltage. C17 and R11 comprise the compensation network. The output voltage of TL431 is converted to the current signal via optocoupler U1 and two resistors R9 and R14 for regulation control.

6 Circuit Operation

6.1 Startup Operation

Since there is a built-in startup cell in the **ICE2QS03G**, there is no need for external start up resistor, which can improve standby performance significantly.

When VCC reaches the turn on voltage threshold 18V, the IC begins with a soft start. The soft-start implemented in **ICE2QS03G** is a digital time-based function. The preset soft-start time is 12ms with 4 steps. If not limited by other functions, the peak voltage on CS pin will increase step by step from 0.32V to 1V finally. After IC turns on, the Vcc voltage is supplied by auxiliary windings of the transformer.

6.2 Normal Mode Operation

The secondary output voltage is built up after startup. The secondary regulation control is adopted with TL431 and optocoupler. The compensation network C17 and R11 constitutes the external circuitry of the error amplifier of TL431. This circuitry allows the feedback to be precisely controlled with respect to dynamically varying load conditions, therefore providing stable control.

6.3 Primary side peak current control

The MOSFET drain source current is sensed via external resistor R8 and buffer network R7, C6. Since ICE2QS03G is a current mode controller, it would have a cycle-by-cycle primary current and feedback voltage control which can make sure the maximum power of the converter is controlled in every switching cycle.

6.4 Digital Frequency Reduction

During normal operation, the switching frequency for **ICE2QS03G** is digitally reduced with decreasing load. At light load, the CoolMOS™ **IPU60R950C6** will be turned on not at the first minimum drain-source voltage time, but on the nth. The counter is in range of 1 to 7, which depends on feedback voltage in a time-base. The feedback voltage decreases when the output power requirement decreases, and vice versa. Therefore, the counter is set by monitoring voltage V_{FB} . The counter will be increased with low V_{FB} and decreased with high V_{FB} . The thresholds are preset inside the IC.

6.5 Burst Mode Operation

At light load condition, the SMPS enters into Active Burst Mode. At this stage, the controller is always active but the Vcc must be kept above the switch off threshold. During active burst mode, the efficiency increase significantly and at the same time it supports low ripple on V_{out} and fast response on load jump.

For determination of entering Active Burst Mode operation, three conditions apply:

1. The feedback voltage is lower than the threshold of $V_{FBEB}(1.25V)$. Accordingly, the peak current sense voltage across the shunt resistor is 0.1667;
2. The up/down counter is 7;
3. And a certain blanking time ($t_{BEB}=24ms$).

Once all of these conditions are fulfilled, the Active Burst Mode flip-flop is set and the controller enters Active Burst Mode operation. This multi-condition determination for entering Active Burst Mode operation prevents mis-triggering of entering Active Burst Mode operation, so that the controller enters Active Burst Mode operation only when the output power is really low during the preset blanking time.

During active burst mode, the maximum current sense voltage is reduced from 1V to 0.34V so as to reduce the conduction loss and the audible noise. At the burst mode, the FB voltage is changing like a sawtooth between 3.0 and 3.6V.

The feedback voltage immediately increases if there is a high load jump. This is observed by one comparator. As the current limit is 34% during Active Burst Mode a certain load is needed so that feedback voltage can exceed VLB (4.5V). After leaving active burst mode, maximum current can now be provided to stabilize V_O . In addition, the up/down counter will be set to 1 immediately after leaving Active Burst Mode. This is helpful to decrease the output voltage undershoot

7 Protection Features

7.1 VCC over voltage and under voltage protection

During normal operation, the Vcc voltage is continuously monitored. When the Vcc voltage increases up to V_{VCCOVp} or Vcc voltage falls below the under voltage lock out level V_{VCCoff} , the IC will enter into autorestart mode.

7.2 Foldback point protection

For a quasi-resonant flyback converter, the maximum possible output power is increased when a constant current limit value is used for all the mains input voltage range. This is usually not desired as this will increase additional cost on transformer and output diode in case of output over power conditions.

The internal foldback protection is implemented to adjust the VCS voltage limit according to the bus voltage. Here, the input line voltage is sensed using the current flowing out of **ZC** pin, during the MOSFET on-time. As the result, the maximum current limit will be lower at high input voltage and the maximum output power can be well limited versus the input voltage.

7.3 Over load/Open loop protection

In case of open control loop, feedback voltage is pulled up with internally block. After a fixed blanking time, the IC enters into auto restart mode. In case of secondary short-circuit or overload, regulation voltage V_{FB} will also be pulled up, same protection is applied and IC will auto restart.

7.4 Adjustable output overvoltage protection

During off-time of the power switch, the voltage at the zero-crossing pin ZC is monitored for output overvoltage detection. If the voltage is higher than the preset threshold 3.7V for a preset period 100 μ s, the IC is latched off.

7.5 Short winding protection

The source current of the MOSFET is sensed via external resistor R8. If the voltage at the current sensing pin is higher than the preset threshold V_{CSSW} of 1.68V during the on-time of the power switch, the IC is latched off. This constitutes a short winding protection. To avoid an accidental latch off, a spike blanking time of 190ns is integrated in the output of internal comparator.

7.6 Auto restart for over temperature protection

The IC has a built-in over temperature protection function. When the controller's temperature reaches 140 °C, the IC will shut down switch and enters into autorestart. This can protect power MOSFET from overheated.

8.1 1st PCB artwork (top)

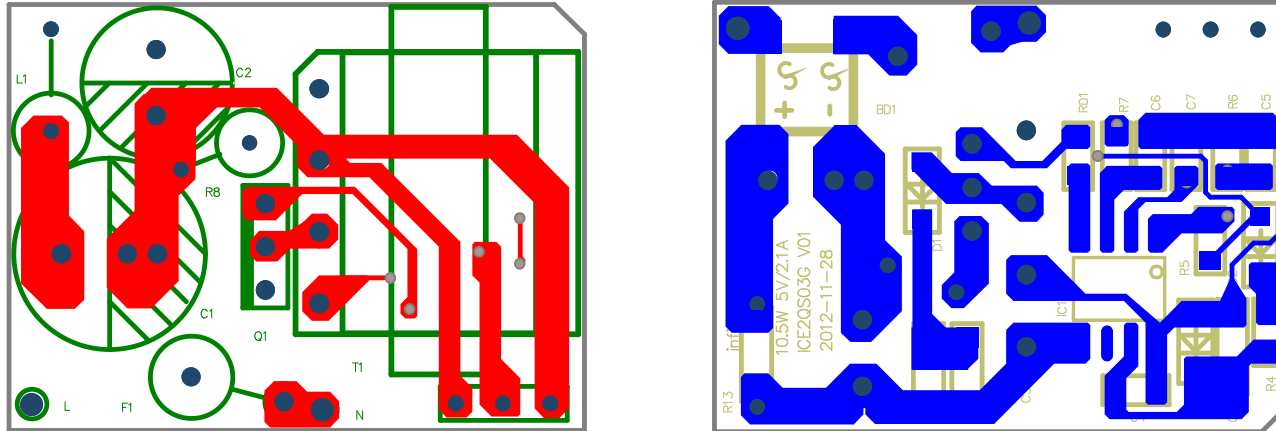

Figure 3 – View from component side (left) and solder side (right)

8.2 2nd PCB artwork (bottom)

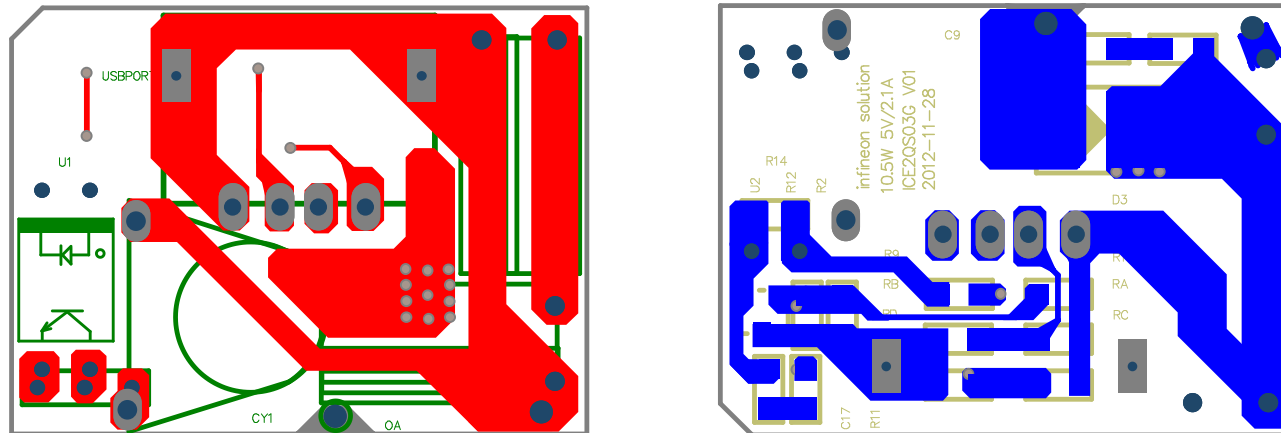

Figure 4 – View from component side (left) and solder side (right)

9 Component List

Items	Designator	Part Value	Q'ty	Manufacturer
1	BD1	B10S/0.5A, 1000V (bridge rectifier)	1	
2	C1	15uF/400V/105°C	1	
3	C10	820uF/6.3V	1	
4	C11	10uF/25V/X7R	1	Murata
5	C17	100nF/X7R	1	
6	C2	6.8uF/400V/105°C	1	
7	C3	4.7nF/630V/X7R	1	
8	C4	2.2uF/25V/X7R	1	Murata
9	C5	68pF/50V/NP0	1	Murata
10	C6	100pF/50V/NP0	1	Murata
11	C7	1nF/50V/X7R	1	Murata
12	C8	820uF/6.3V	1	
13	C9	1nF/50V/X7R	1	
14	CY1	2.2nF/250Vac	1	
15	D1	F1J-600V/1A/1.25V	1	
16	D2	BAV21W	1	
17	D3	SBR10U45SP5-45V/10.0A/0.42V	1	
18	F1	T1A/250V	1	
19	IC1	ICE2QS03G	1	Infineon
20	L1	0.9mH/0.1A/φ0.12	1	
21	Q1	N MOS-IPU60R950C6	1	Infineon
22	R1	10K/0805,±1%	1	
23	R10	22.1R/0805,±5%	1	
24	R11	22.1K/0805,±5%	1	
25	R12	N.A	1	
26	R13	51.1R/1206, ±1%	1	
27	R14	562R/0805, ±1%	1	
28	R2	10K/0805,±1%	1	
29	R3	56.2K/1206, ±1%	1	
30	R4	4R02/0805, ±5%	1	
31	R5	51.1K/0805, ±1%	1	
32	R6	10K/0805,±1%	1	
33	R7	100R/0805, ±1%	1	
34	R8	1.5R/0.5W, ±1%	1	
35	R9	150R/0805,±5%	1	
36	RA	43.2K/0805, ±1%	1	
37	RB	51.1K/0805, ±1%	1	
38	RC	75K/0805, ±1%	1	
39	RD	51.1K/0805, ±1%	1	
40	RD1	47.5R/0805, ±1%	1	
41	T1	750341723 (EE19)	1	Würth Electronics Midcom
42	U1	SFH617A-3	1	
43	U2	TL431	1	
44	USBPORT	6Pin-USB,90°C	1	
45	ZD1	MMSZ22T1G	1	
46	L	37MM-UL1007 22#-red	1	
47	N	37MM-UL1007 22#-black	1	

10 Transformer Construction

Core and material: EE19, 3C90 (other equivalent ferrite)
Bobbin: EE19 Vertical Version
Primary Inductance: $L_p=1.6\text{mH}$ ($\pm 10\%$), measured between pin 6 and pin 4
Manufacturer and part number: Würth Electronics Midcom (750341723)

Transformer structure:

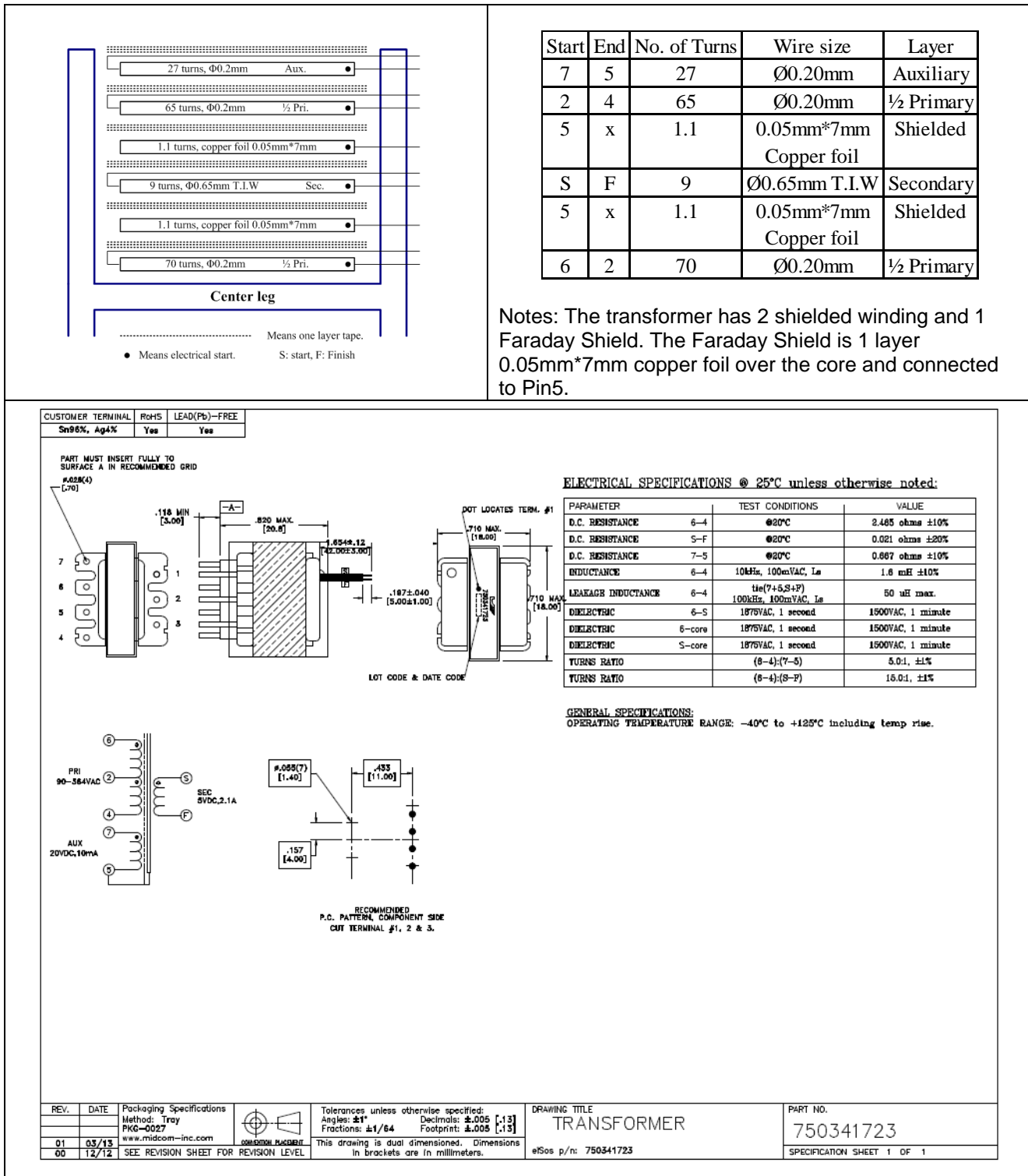

Figure 5 – Transformer structure

11 Test Results

11.1 Efficiency

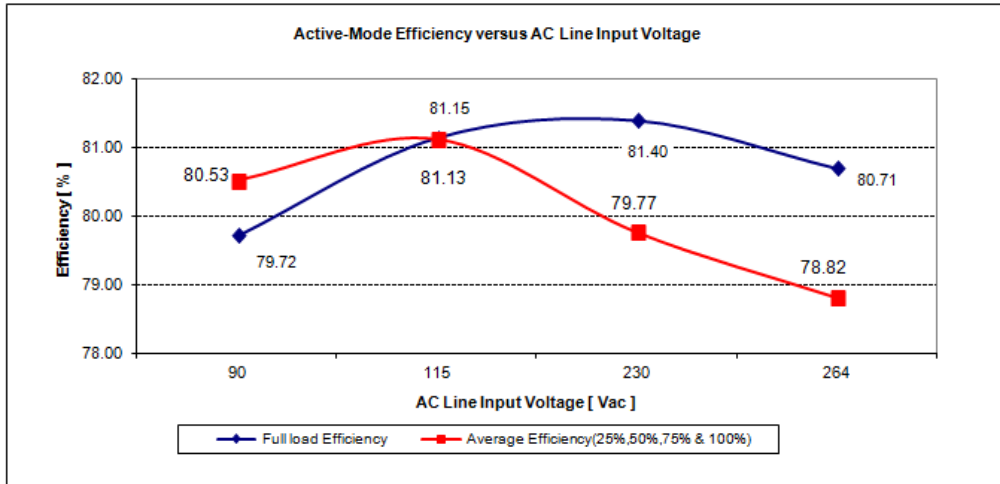

Figure 6 – Efficiency vs. AC line voltage

11.2 Input standby power

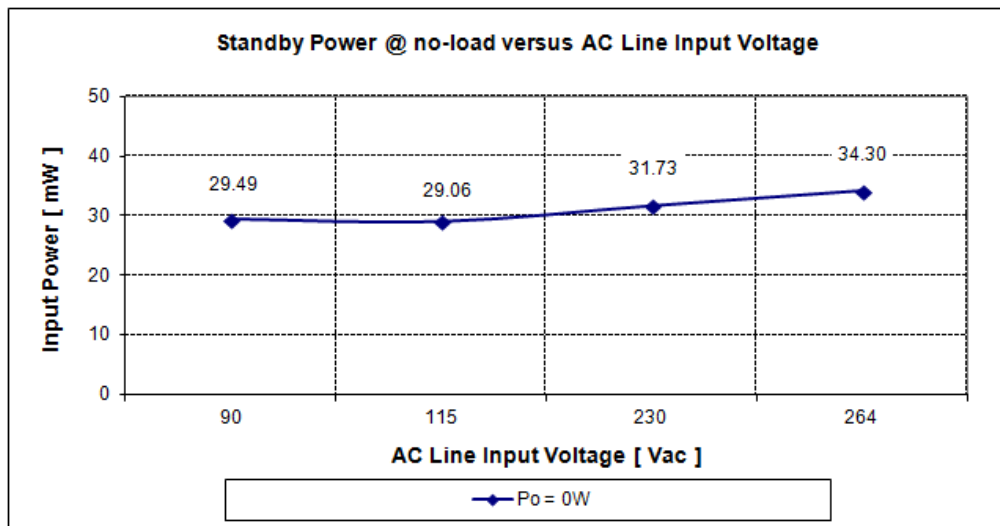

Figure 7 – Input standby power @ no load Vs. AC line input voltage (measured by Yokogawa WT210 power meter - integration mode)

11.3 Line regulation

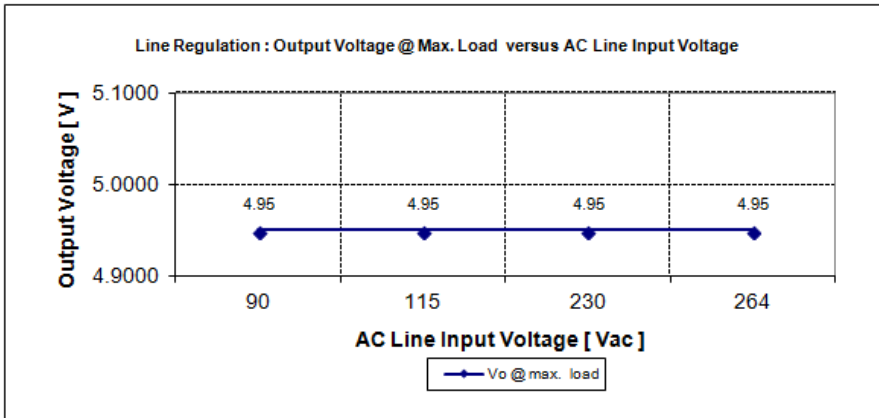

Figure 8 – Line regulation Vout @ full load vs. AC line input voltage

11.4 Load regulation

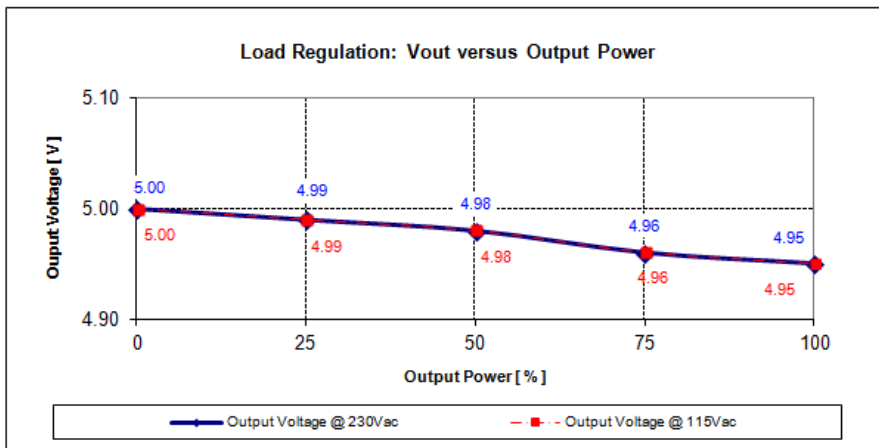

Figure 9 – Load regulation Vout vs. output power

11.5 Maximum input power between low and high line

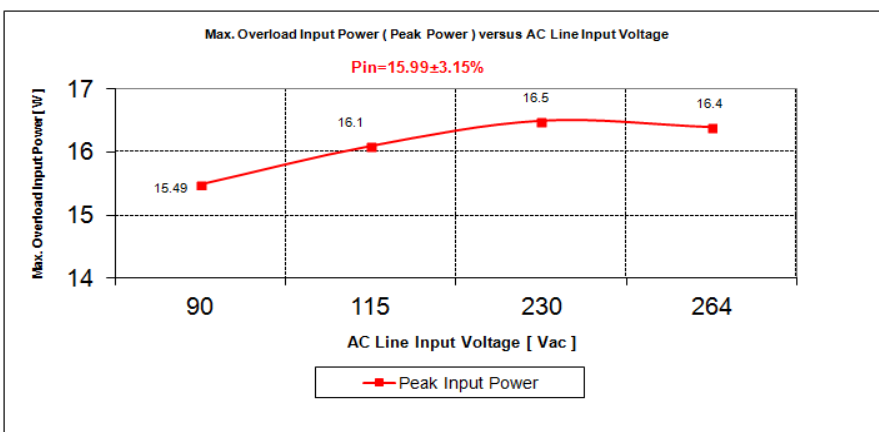

Figure 10 – Maximum input power (before overload protection) vs. AC line input voltage

11.6 EMI test results

The conducted EMI was measured by Schaffner (SMR4503) under test standard EN55022 or CISPR22 Class B. The demo board was set up at 10.5W with the input voltage at 115Vac and 230Vac. The Red curve(upper one) is the Quasi Peak data and the Green curve(lower one) is the Average data. Both of them can meet the regulations, pass conducted emissions EN55022 (CISPR 22) class B with > 6dB margin.

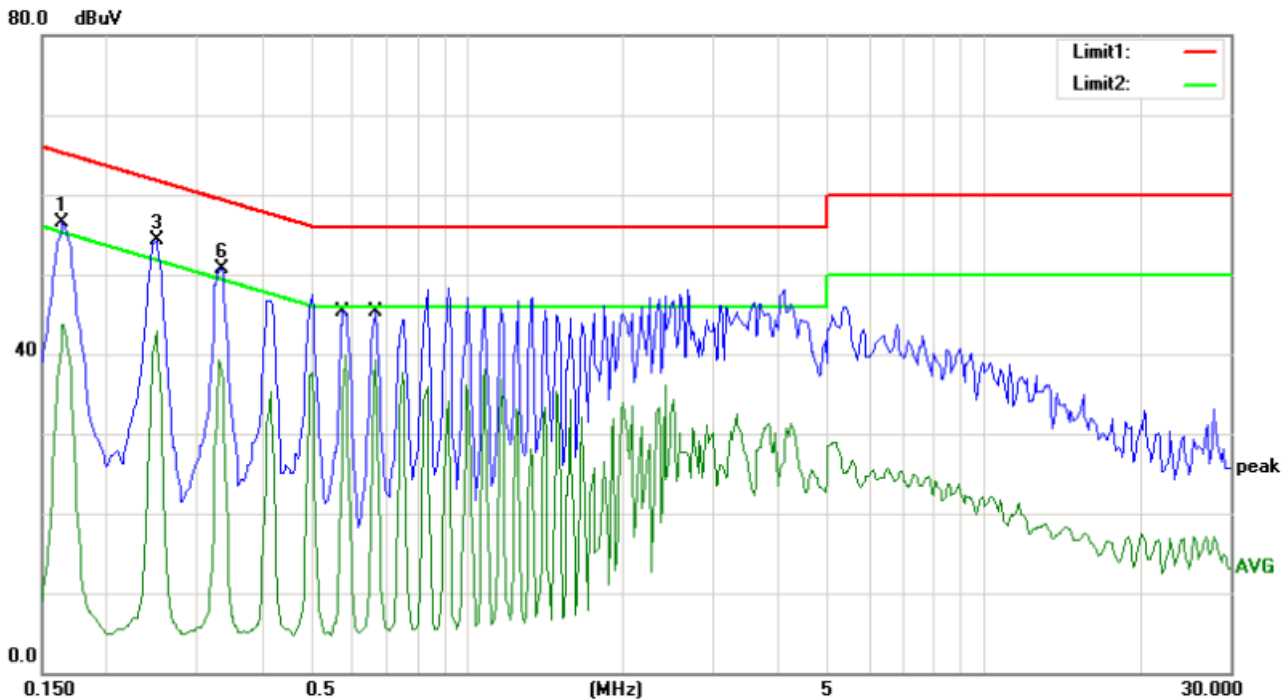

Figure 11 – 230V Line results

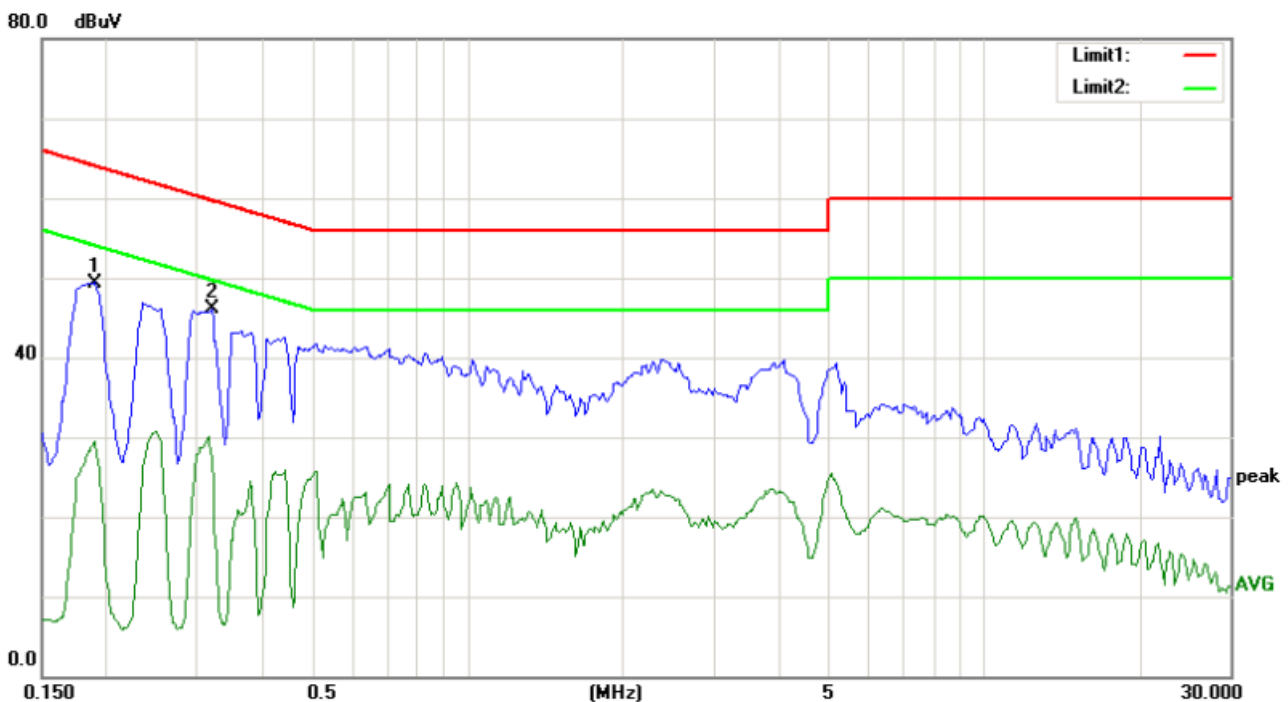

Figure 12 – 115V Line results

12 Waveforms and Scope Plots

12.1 Startup at Full Load

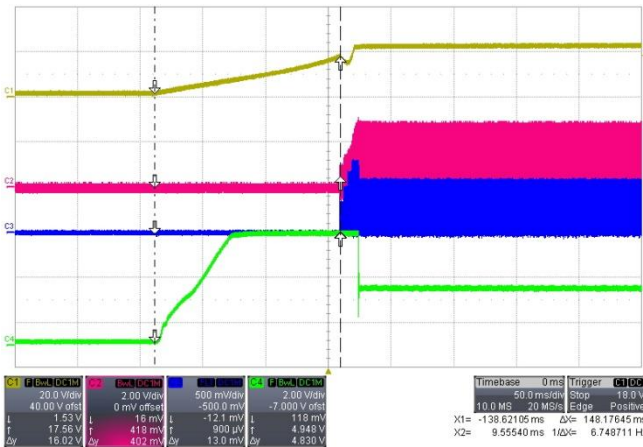

Figure 13 – Constant Charging V_{CC} at Startup
CH1(Yellow) Supply Voltage, V_{CC}
CH2(Red) Zero Crossing Voltage, V_{ZC}
CH3(Blue) Current Sense Voltage, V_{CS}
CH4(Green) Feedback Voltage, V_{FB}

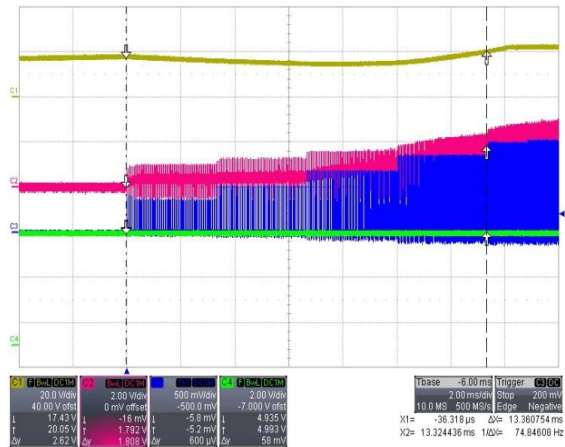

Figure 14 – Step Softstart
CH1(Yellow) Supply Voltage, V_{CC}
CH2(Red) Zero Crossing Voltage, V_{ZC}
CH3(Blue) Current Sense Voltage, V_{CS}
CH4(Green) Feedback Voltage, V_{FB}

12.2 Drain and V_{CS} voltage at maximum load

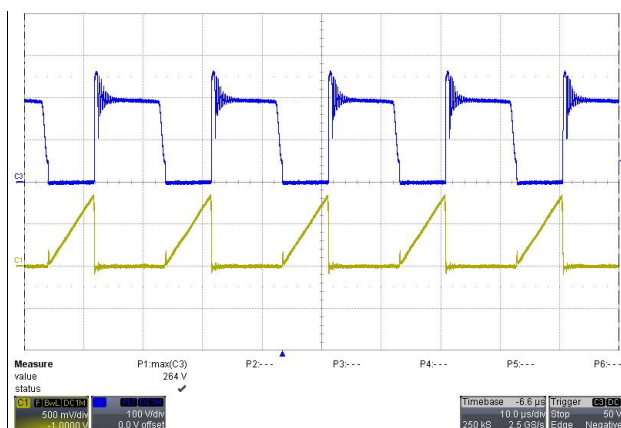

Figure 15 - Operation @ 90Vac and max. load
Ch1= V_{cs} (Yellow), Ch3= V_{ds} (Blue)
 V_{in} =90Vac, I_{out} =2.1A(full load)
 V_{ds_max} =264V

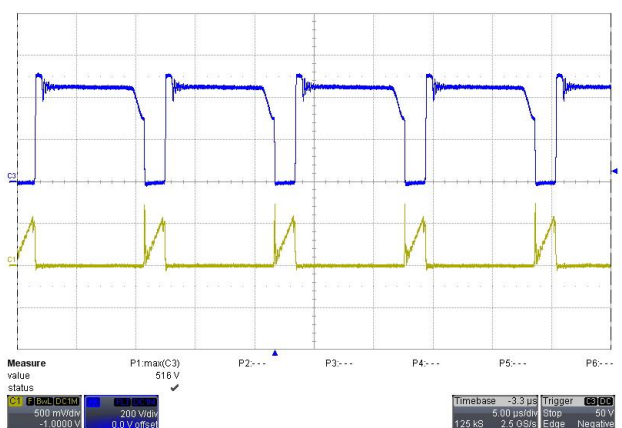

Figure 16 - Operation @ 264Vac and max. load
Ch1= V_{cs} (Yellow), Ch3= V_{ds} (Blue)
 V_{in} =264Vac, I_{out} =2.1A(full load)
 V_{ds_max} =516V

12.3 Zero Crossing Point during Normal Operation

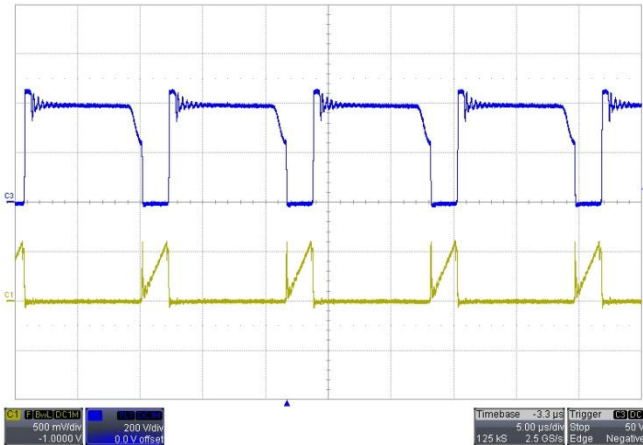

Figure 17 – Working at 1st ZC
CH1(Yellow) Current Sense Voltage, V_{CS}
CH3(Blue) MOSFET Dain-Source Voltage, V_{DS}

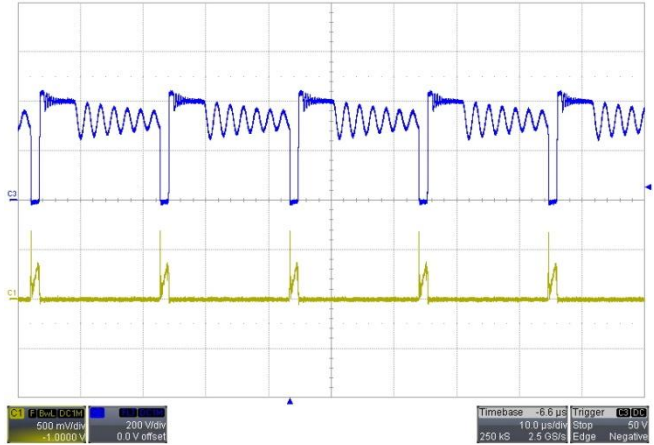

Figure 18 – Working at 7th ZC
CH1(Yellow) Current Sense Voltage, V_{CS}
CH2 MOSFET Dain-Source Voltage, V_{DS}

12.4 Load Transient Response

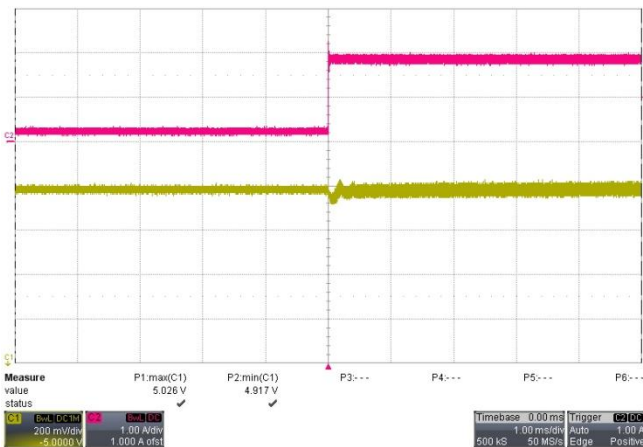

Figure 19 – AC Output Ripple Undershoot
10% → 100% load, 0.4A/us
 $V_{O_max}=5.026V$
 $V_{O_min}=4.917V$
 $V_{ripple_pk_pk}=109mV$
CH1 Output Voltage, V_o
CH2 Output Current, I_o

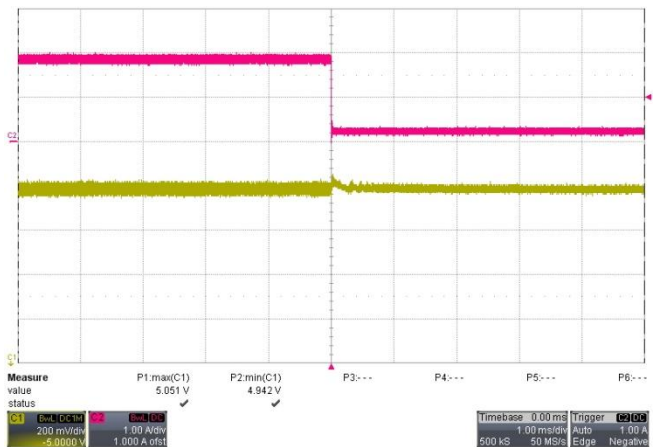

Figure 20 – AC Output Ripple Overshoot
100% → 10% load, 0.4A/us
 $V_{O_max}=5.051V$
 $V_{O_min}=4.942V$
 $V_{ripple_pk_pk}=109mV$
CH1 Output Voltage, V_o
CH2 Output Current, I_o

12.5 Burst Mode Operation

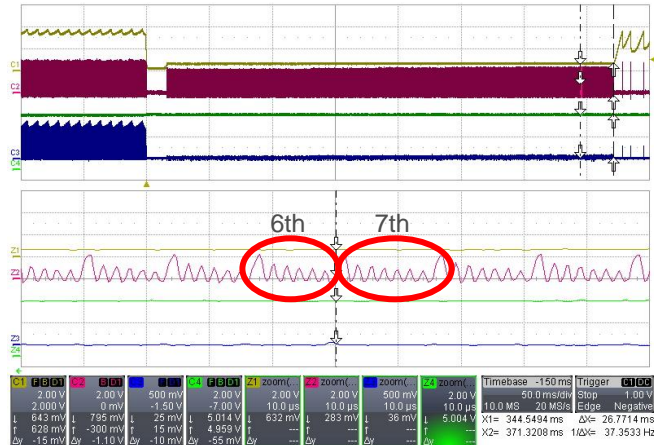

Figure 21 – Entering Burst Mode
 CH1(Yellow) Feedback Voltage, V_{FB}
 CH2(Red) Zero Crossing Voltage, V_{ZC}
 CH3(Blue) Current Sense Voltage, V_{CS}
 CH4(Green) Output Voltage, V_O
 Condition: $ZC=7$, $FB<1.25V$, Blanking time = 26ms

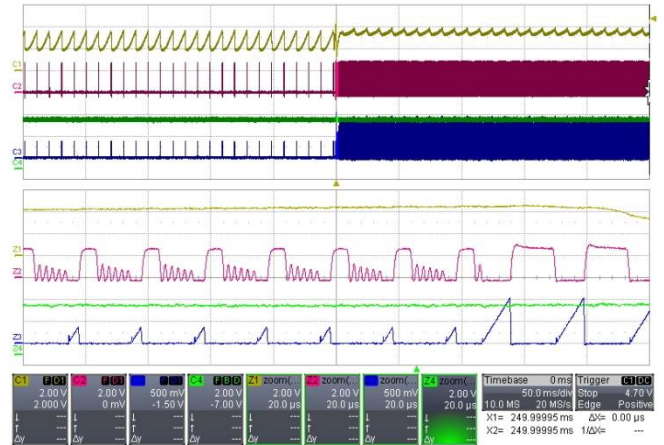

Figure 22 – Leaving Burst Mode
 CH1(Yellow) Feedback Voltage, V_{FB}
 CH2(Red) Zero Crossing Voltage, V_{ZC}
 CH3(Blue) Current Sense Voltage, V_{CS}
 CH4(Green) Output Voltage, V_O
 Condition: $V_{FB}>4.5V$

12.6 Protection Mode

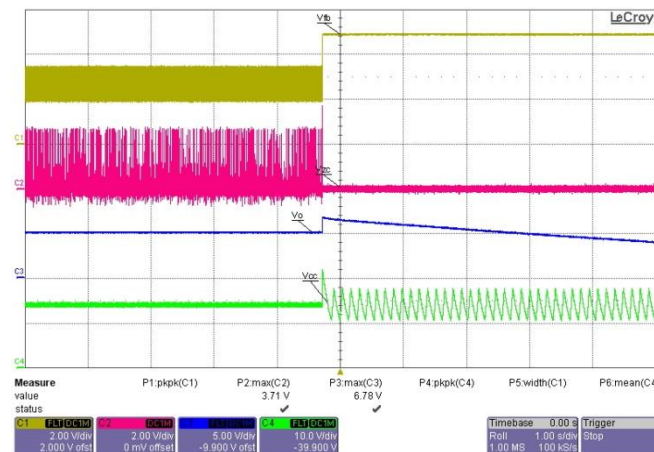

Figure 23 – Vout Over Voltage Protection
 CH1(Yellow) Feedback Voltage, V_{FB}
 CH2(Red) Zero Crossing Voltage, V_{ZC}
 CH3(Blue) Output Voltage, V_O
 CH4(Green) Supply Voltage, V_{CC}
 Condition: $V_O > 6.7V$ ($V_{ZC} > 3.7V$)

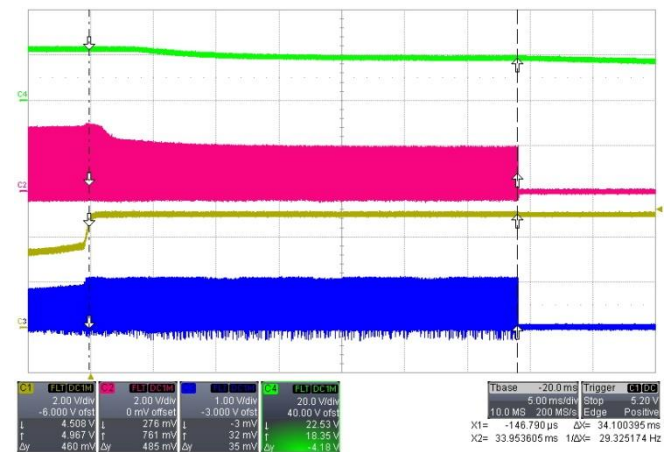

Figure 24 – Over Load/Open Loop Protection
 CH1(Yellow) Feedback Voltage, V_{FB}
 CH2(Red) Zero Crossing Voltage, V_{ZC}
 CH3(Blue) Current Sense Voltage, V_{CS}
 CH4(Green) Supply Voltage, V_{CC}
 Condition: $V_{FB}>4.5V$ for 30ms

13 References

- [1] ICE2QS03G datasheet, Infineon Technologies AG
- [2] IPU60R950C6 datasheet, 600V CoolMOS™ C6 Power Transistor
- [3] Converter Design Using the Quasi-Resonant PWM Controller ICE2QS01, Infineon Technologies AG, 2006. [ANPS0003]
- [4] Design tips for flyback converters using the Quasi-Resonant PWM controller ICE2QS01, Infineon Technologies, 2006. [ANPS0005]
- [5] Determine the switching frequency of Quasi-Resonant flyback converters designed with ICE2QS01, Infineon Technologies, 2006. [ANPS0004]
- [6] ICE2QS03G design guide. [ANPS0027]
- [7] 36W Evaluation Board with Quasi-Resonant PWM Controller ICE2QS03G, 2011. [AN-PS0040]

www.infineon.com

Published by Infineon Technologies AG



Компания «ЭлектроПласт» предлагает заключение долгосрочных отношений при поставках импортных электронных компонентов на взаимовыгодных условиях!

Наши преимущества:

- Оперативные поставки широкого спектра электронных компонентов отечественного и импортного производства напрямую от производителей и с крупнейших мировых складов;
- Поставка более 17-ти миллионов наименований электронных компонентов;
- Поставка сложных, дефицитных, либо снятых с производства позиций;
- Оперативные сроки поставки под заказ (от 5 рабочих дней);
- Экспресс доставка в любую точку России;
- Техническая поддержка проекта, помощь в подборе аналогов, поставка прототипов;
- Система менеджмента качества сертифицирована по Международному стандарту ISO 9001;
- Лицензия ФСБ на осуществление работ с использованием сведений, составляющих государственную тайну;
- Поставка специализированных компонентов (Xilinx, Altera, Analog Devices, Intersil, Interpoint, Microsemi, Aeroflex, Peregrine, Syfer, Eurofarad, Texas Instrument, Miteq, Cobham, E2V, MA-COM, Hittite, Mini-Circuits, General Dynamics и др.);

Помимо этого, одним из направлений компании «ЭлектроПласт» является направление «Источники питания». Мы предлагаем Вам помощь Конструкторского отдела:

- Подбор оптимального решения, техническое обоснование при выборе компонента;
- Подбор аналогов;
- Консультации по применению компонента;
- Поставка образцов и прототипов;
- Техническая поддержка проекта;
- Защита от снятия компонента с производства.



Как с нами связаться

Телефон: 8 (812) 309 58 32 (многоканальный)

Факс: 8 (812) 320-02-42

Электронная почта: org@eplast1.ru

Адрес: 198099, г. Санкт-Петербург, ул. Калинина, дом 2, корпус 4, литера А.