

### LSP05 Module Series

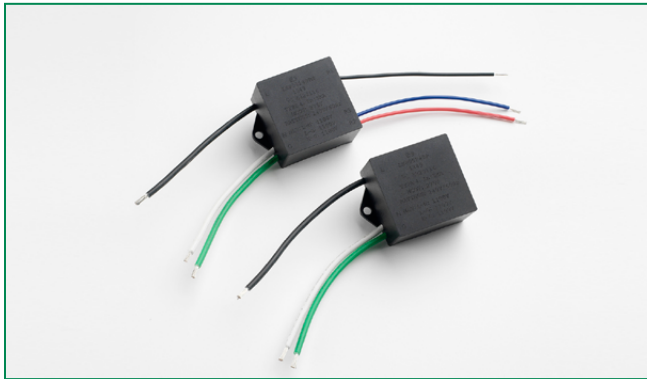

#### Description

The Littelfuse LSP05 thermally protected Surge Protective Device is a self-protected device which is specially designed to be used in outdoor and commercial LED lighting fixtures for transient overvoltage protection. It is constructed with Littelfuse thermally protected varistor technology. Its built-in thermal disconnect function provides additional protection to prevent catastrophic failure and fire hazard even under the extreme circumstances of varistor end-of-life or sustaining over voltage conditions. The LSP05 SPD facilitates customer's product compliance to IEEE C62.41.2 Location Category C Low and US Dept of Energy MSSLC Model Spec.

#### Agency Approvals

Agency	Standard	Agency File Number
	UL1449 3rd Edition	E320116

#### Applications

- Outdoor and Commercial LED Lighting
- Roadway lighting
- Traffic lighting
- Digital signage
- Wash wall lighting
- Parking garage/lot lighting
- Flood lighting
- Tunnel lighting
- Street lighting

#### Features

- Maximum Discharge Current, 10kA, 8/20us
- Meets ANSI C136.2/ IEEE C62.41.2 Location Category C Low Exposure
- Parallel connected SPD device
- Thermally protected Varistor technology
- IP66 Water-proof and Dust-proof
- Indication wire lead options for Parallel connected modules
- CE Compliance IEC61643-11 Class II/ EN61643-11 Type 2
- Compact form factor (48x48x30mm) with mounting tabs
- 240Vac and 277Vac voltage ratings are CE compliant and available for Class I and Class II installation based on IEC protection classes

#### Additional Information



Datasheet



Resources



Samples

#### Absolute Maximum Ratings

• For ratings of individual members of a series, see Device Ratings and Specifications chart

	LSP05 Series	Units
<b>Continuous:</b>		
<b>Steady State Applied Voltage:</b>		
Max AC Voltage Range ( $V_{M(ACRMS)}$ )	150 to 510	V
<b>Transient:</b>		
Maximum Discharge Current 8/20 $\mu$ s Waveform ( $I_{max}$ )	10,000	A
Nominal Discharge Current 8/20 $\mu$ s Waveform ( $I_n$ )	5,000	A
Operating Ambient Temperature Range ( $T_A$ )	-45 to +85	°C
Storage Temperature Range ( $T_{STG}$ )	-45 to +125	°C
Isolation Voltage Capability (When the thermal disconnect opens)	600	V
Insulation Resistance	>1,000	M $\Omega$

**CAUTION:** Stresses above those listed in "Absolute Maximum Ratings" may cause permanent damage to the device. This is a stress only rating and operation of the device at these or any other conditions above those indicated in the operational sections of this specification is not implied.

#### Notes:

- These parts are in compliance with IEC61643-11 Class II (Low Voltage System) and EN61643-11 Type 2 (Low Voltage System).
- Tested for temporary overvoltage from low-voltage system faults per IEC 61643-11

## LSP05 Series Device Ratings & Specifications

Part Number	Operating Voltage (VAC)	MCOV/Uc (VAC)	Maximum Discharge Current (Imax)(A) <sup>2</sup>	Nominal Discharge Current (In)(A) <sup>1</sup>	MLV (V) <sup>3</sup>	Up (V) <sup>4</sup>
LSP05120P	120	150	10,000	5,000	L-N:680 L-G:680 N-G:630	800
LSP05240P	240	275	10,000	5,000	L-N:1100 L-G:1100 N-G:1100	1200
LSP05277P	277	320	10,000	5,000	L-N:1270 L-G:1270 N-G:1220	1400
LSP05347P	347	420	10,000	5,000	L-N:1600 L-G:1600 N-G:1580	1700
LSP05480P	480	510	10,000	5,000	L-N:1780 L-G:1780 N-G:1730	1900
LSP05240LLP	L-L:240	L-L:275	10,000	5,000	L-L:1100	L-L:1200
	L-N/G:120	L-N/G:150			L-N/G:680	L-N/G:800
LSP05480LLP	L-L:480	L-L:510	10,000	5,000	L-L:1780	L-L:1900
	L-N/G:277	L-N/G:320			L-N/G:1270	L-N/G:1400

Notes:

- Nominal Discharge Current (In)(A): The nominal discharge current is a measure of the SPDs endurance capability; 15 impulses of discharge current uses the 8/20us current waveform.
- Maximum Discharge Current (Imax)(A): The maximum discharge current is a measure of the SPDs maximum capability; single impulse of discharge current uses the 8/20us current waveform.
- MLV – UL1449 Measured limiting voltage; the highest value of residual voltage measurements during the application of impulses of 8/20us nominal discharge current (In); an average voltage value of 15 impulses
- Up – IEC 61643-11 Voltage protection level; the highest value of residual voltage measurements during the application of impulses of 8/20us nominal discharge current (In); a rounding voltage value of maximum measurement.

## Dimensions

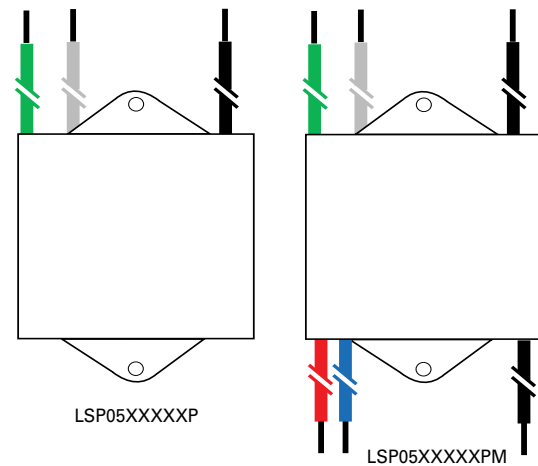
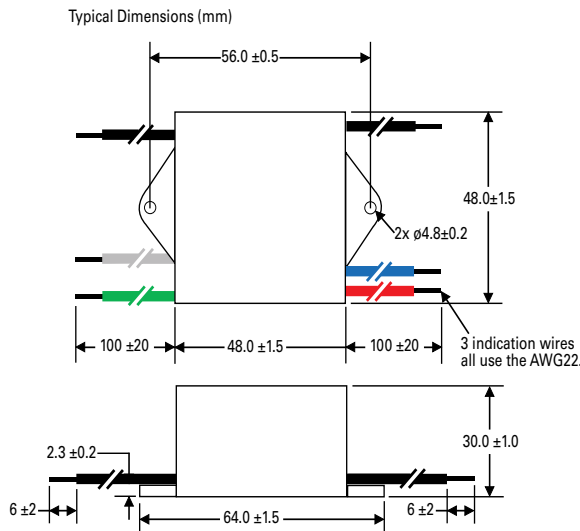

Notes:

- Black: Line; White: Neutral; Green: Ground  
(P/N with suffix X3333/X3316: Brown: Line; Blue: Neutral; Green-Yellow stripe: Ground)
- Black: R1; Red: R2; Blue: R3
- Wire Gauge: AWG14 wire Line in, AWG22 Wire for indication; Wire Length: 100mm or customized

**Application/Installation Schematic**

**Part Numbering System**

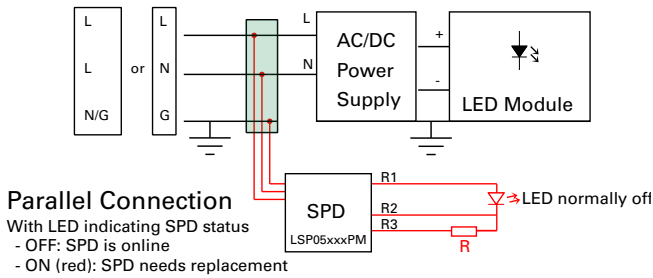
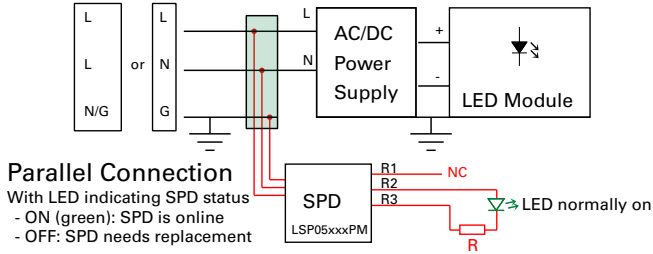

Notes:  
1. LED indicator and associated circuitry are not included in the module.

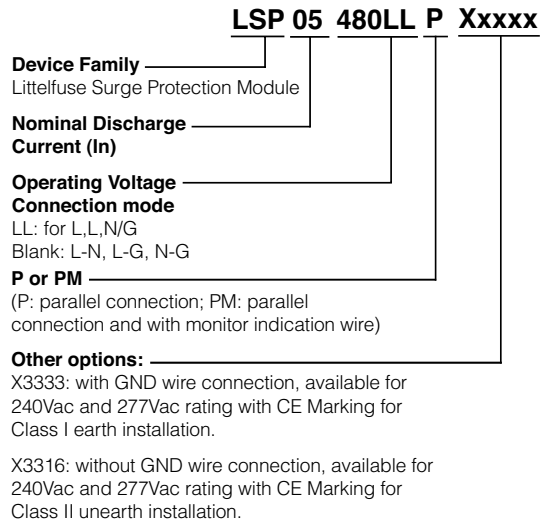
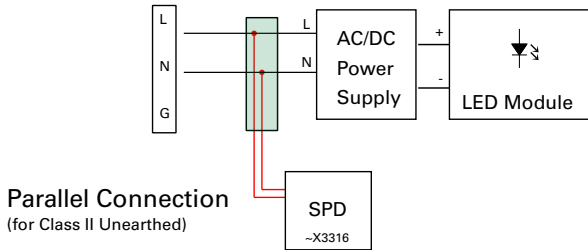
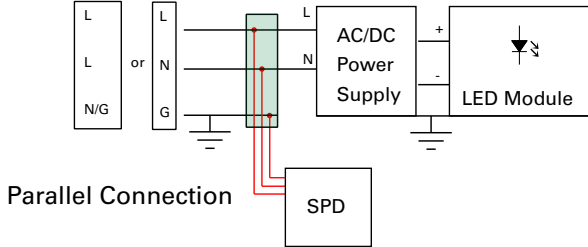



Компания «ЭлектроПласт» предлагает заключение долгосрочных отношений при поставках импортных электронных компонентов на взаимовыгодных условиях!

Наши преимущества:

- Оперативные поставки широкого спектра электронных компонентов отечественного и импортного производства напрямую от производителей и с крупнейших мировых складов;
- Поставка более 17-ти миллионов наименований электронных компонентов;
- Поставка сложных, дефицитных, либо снятых с производства позиций;
- Оперативные сроки поставки под заказ (от 5 рабочих дней);
- Экспресс доставка в любую точку России;
- Техническая поддержка проекта, помощь в подборе аналогов, поставка прототипов;
- Система менеджмента качества сертифицирована по Международному стандарту ISO 9001;
- Лицензия ФСБ на осуществление работ с использованием сведений, составляющих государственную тайну;
- Поставка специализированных компонентов (Xilinx, Altera, Analog Devices, Intersil, Interpoint, Microsemi, Aeroflex, Peregrine, Syfer, Eurofarad, Texas Instrument, Miteq, Cobham, E2V, MA-COM, Hittite, Mini-Circuits, General Dynamics и др.);

Помимо этого, одним из направлений компании «ЭлектроПласт» является направление «Источники питания». Мы предлагаем Вам помощь Конструкторского отдела:

- Подбор оптимального решения, техническое обоснование при выборе компонента;
- Подбор аналогов;
- Консультации по применению компонента;
- Поставка образцов и прототипов;
- Техническая поддержка проекта;
- Защита от снятия компонента с производства.



#### Как с нами связаться

**Телефон:** 8 (812) 309 58 32 (многоканальный)

**Факс:** 8 (812) 320-02-42

**Электронная почта:** [org@eplast1.ru](mailto:org@eplast1.ru)

**Адрес:** 198099, г. Санкт-Петербург, ул. Калинина, дом 2, корпус 4, литера А.