

20-, 40-, and 60-Bit I/O Expander with EEPROM

Features

- I²C interface logic electrically compatible with SMBus
- Up to 20 (CY8C9520A), 40 (CY8C9540A), or 60 (CY8C9560A) I/O data pins independently configurable as inputs, outputs, Bi-directional input/outputs, or PWM outputs
- 4/8/16 PWM sources with 8-bit resolution
- Extendable soft addressing algorithm allowing flexible I²C address configuration
- Internal 3-/11-/27-Kbyte EEPROM
- User default storage, I/O port settings in internal EEPROM
- Optional EEPROM write disable (WD) input
- Interrupt output indicates input pin level changes and pulse width modulator (PWM) state changes
- Internal power on reset (POR)
- Internal configurable watchdog timer

Top Level Block Diagram



Overview

The CY8C95xxA is a multi-port I/O expander with on board user available EEPROM and several PWM outputs. All devices in this family operate identically but differ in I/O pins, number of PWMs, and internal EEPROM size.

The CY8C95xxA operates as two I²C slave devices. The first device is a multi port I/O expander (single I²C address to access all ports through registers). The second device is a serial EEPROM. Dedicated configuration registers can be used to disable the EEPROM. The EEPROM uses 2-byte addressing to support the 28 Kbyte EEPROM address space. The selected device is defined by the most significant bits of the I²C address or by specific register addressing.

The I/O expander's data pins can be independently assigned as inputs, outputs, quasi-bidirectional input/outputs or PWM outputs. The individual data pins can be configured as open drain or collector, strong drive (10 mA source, 25 mA sink), resistively pulled up or down, or high impedance. The factory default configuration is pulled up internally.

The system master writes to the I/O configuration registers through the I²C bus. Configuration and output register settings are storable as user defaults in a dedicated section of the EEPROM. If user defaults were stored in EEPROM, they are restored to the ports at power up. While this device can share the bus with SMBus devices, it can only communicate with I²C masters. The I²C slave in this device requires that the I²C master supports clock stretching.

There is one dedicated pin that is configured as an interrupt output (INT) and can be connected to the interrupt logic of the system master. This signal can inform the system master that there is incoming data on its ports or that the PWM output state was changed.

The EEPROM is byte readable and supports byte-by-byte writing. A pin can be configured as an EEPROM Write Disable (WD) input that blocks write operations when set high. The configuration registers can also disable EEPROM operations.

The CY8C95xxA has one fixed address pin (A0) and up to six additional pins (A1-A6), which allow up to 128 devices to share a common two wire I²C data bus. The Extendable Soft Addressing algorithm provides the option to choose the number of pins needed to assign the desired address. Pins not used for address bits are available as GPIO pins.

There are 4 (CY8C9520A), 8 (CY8C9540A), or 16 (CY8C9560A) independently configurable 8-bit PWMs. These PWMs are listed as PWM0-PWM15. Each PWM can be clocked by one of six available clock sources.

Errata: For information on silicon errata, see [Errata on page 30](#). Details include trigger conditions, devices affected, and proposed workaround.

Contents

Architecture	3	Commands Description	14
Applications	3	Store Config to E2 POR Defaults Cmd (01h)	14
Device Access Addressing	4	Restore Factory Defaults Cmd (02h)	14
Serial EEPROM Device	4	Write E2 POR Defaults Cmd (03h)	14
Multi Port I/O Device	4	Read E2 POR Defaults Cmd (04h)	15
Pinouts	5	Write Device Config Cmd (05h)	15
28-Pin Part Pinout	5	Read Device Config Cmd (06h)	15
48-Pin Part Pinout	6	Reconfigure Device Cmd (07h)	15
100-Pin Part Pinout	7	Electrical Specifications	16
Pin Descriptions	9	Absolute Maximum Ratings	16
Extendable Soft Addressing	9	Operating Temperature	16
Interrupt Pin (INT)	9	DC Electrical Characteristics	17
Write Disable Pin (WD)	9	AC Electrical Characteristics	19
External Reset Pin (XRES)	9	Packaging Dimensions	21
Working with PWMs	9	Thermal Impedances	23
Register Mapping Table	11	Solder Reflow Specifications	23
Register Descriptions	11	Features and Ordering Information	24
Input Port Registers (00h–07h)	11	Ordering Code Definitions	24
Output Port Registers (08h–0Fh)	11	Acronyms	25
Int. Status Port Registers (10h–17h)	12	Reference Documents	25
Port Select Register (18h)	12	Document Conventions	25
Interrupt Mask Port Register (19h)	12	Units of Measure	25
Select PWM Register (1Ah)	12	Numeric Conventions	25
Inversion Register (1Bh)	12	Numeric Naming	25
Port Direction Register (1Ch)	12	Glossary	26
Drive Mode Registers (1Dh–23h)	12	Errata	30
PWM Select Register (28h)	12	Part Numbers Affected	30
Config (29h)	13	Qualification Status	30
Period Register (2Ah)	13	Errata Summary	30
Pulse Width Register (2Bh)	13	Document History Page	31
Divider Register (2Ch)	13	Sales, Solutions, and Legal Information	32
Enable Register (2Dh)	13	Worldwide Sales and Design Support	32
Device ID/Status Register (2Eh)	13	Products	32
Watchdog Register (2Fh)	14	PSoC® Solutions	32
Command Register (30h)	14	Cypress Developer Community	32
		Technical Support	32

Architecture

The [Top Level Block Diagram on page 1](#) illustrates the device block diagram. The main blocks include the control unit, PWMs, EEPROM, and I/O ports. The control unit executes commands received from the I²C bus and transfers data between other bus devices and the master device.

The on chip EEPROM can be separated conventionally into two regions. The first region is designed to store data and is available for byte wide read/writes through the I²C bus. It is possible to prevent write operations by setting the WD pin to high. All EEPROM operations can be blocked by configuration register settings. The second region allows the user to store the port and PWM default settings using special commands. These defaults are automatically reloaded and processed after device power on.

The number of I/O lines and PWM sources are listed in the following table.

Table 1. GPIO Availability

Port	CY8C9520A	CY8C9540A	CY8C9560A
GPort 0	8 bit	8 bit	8 bit
GPort 1	5-8 bit ^[1]	5-8bit ^[1]	5-8 bit ^[1]
GPort 2	0-4 bit ^[1]	0-4it ^[1]	0-4 bit ^[1]
GPort 3	–	8 bit	8 bit
GPort 4	–	8 bit	8 bit
GPort 5	–	4 bit	8 bit
GPort 6	–	–	8 bit
GPort 7	–	–	8 bit
PWMs	4	8	16

There are four pins on GPort 2 and three on GPort 1 that can be used as general purpose I/O or EEPROM Write Disable (WD) and I²C-address input (A1-A6), depending on configuration settings.

[Figure 1](#) shows the single port logical structure. The Port Drive Mode register gives the option to select one of seven available modes for each pin separately: pulled up/down, open drain high/low, strong drive fast/slow, or high impedance. By default these configuration registers store values setting I/O pins to be pulled up. The Invert register enables inversion of the logic of the Input registers separately for each pin. The Select PWM register assigns pins as PWM outputs. All of these configuration registers are read/writable using corresponding commands in the multi-port device.

Figure 1. Logical Structure of the I/O Port

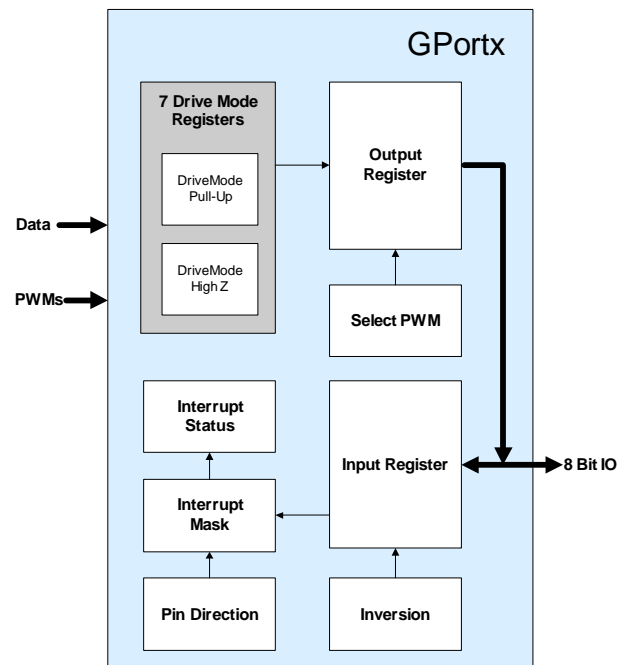

The Port Input and Output registers are separated. When the Output register is written, the data is sent to the external pins. When the Input register is read, the external pin logic levels are captured and transferred. As a result, the read data can be different from written Output register data. This enables implementation of a quasi-bidirectional input-output mode, when the corresponding binary digit is configured as pulled up/down output.

Each port has an Interrupt Mask register and an Interrupt Status register. Each high bit in the Interrupt Status register signals that there has been a change in the corresponding input line since the last read of that Interrupt Status register. The Interrupt Status register is cleared after each read. The Interrupt Mask register enables/disables activation of the INT line when input levels are changed. Each high in the Interrupt Mask register masks (disables) an interrupt generated from the corresponding input line.

Applications

Each GPIO pin can be used to monitor and control various board level devices, including LEDs and system intrusion detection devices.

The on board EEPROM can be used to store information such as error codes or board manufacturing data for read-back by application software for diagnostic purposes.

Note

1. This port contains configuration-dependant GPIO lines or A1-A6 and WD lines.

Device Access Addressing

Following a start condition, the I²C master device sends a byte to address an I²C slave. This address accesses the device in the CY8C95xx. By default there are two possible address formats in binary representation: 010000A0X and 101000A0X. The first is used to access the multi port device and the second to access the EEPROM. If additional address lines (A1-A6) are used then the Device Addressing. [Table 2](#) defines the device addresses. This addressing method uses a technique called Extendable Soft Addressing, described in the section [Extendable Soft Addressing on page 9](#).

Table 2. Device Addressing

Multi-Port Device							EEPROM Device									
01		0	0	0	0	A ₀	R/W	1	0	1	0	0	0	A ₀	R/W	
0	1	0	0	0	0	A ₁	A ₀	R/W	1	0	1	0	0	A ₁	A ₀	R/W
0	1	0	0	0	A ₂	A ₁	A ₀	R/W	1	0	1	0	A ₂	A ₁	A ₀	R/W
0	1	0	A ₃	A ₂	A ₁	A ₀	R/W	1	0	1	A ₃	A ₂	A ₁	A ₀	R/W	
0	1	A ₄	A ₃	A ₂	A ₁	A ₀	R/W	1	0	A ₄	A ₃	A ₂	A ₁	A ₀	R/W	
0	A ₅	A ₄	A ₃	A ₂	A ₁	A ₀	R/W	1	A ₅	A ₄	A ₃	A ₂	A ₁	A ₀	R/W	
A ₆	A ₅	A ₄	A ₃	A ₂	A ₁	A ₀	R/W	A ₆	A ₅	A ₄	A ₃	A ₂	A ₁	A ₀	R/W	

When all address lines A1-A6 are used, the device being accessed is defined by the first byte following the address in the write transaction. If the most significant bit (MSb) of this byte is '0', this byte is treated as a command (register address) byte of the multi-port device. If the MSb is '1', this byte is the first of a 2-byte EEPROM address. In this case, the device masks the MSb to determine the EEPROM address.

Serial EEPROM Device

EEPROM reading and writing operations require 2 bytes, AHI and ALO, which indicate the memory address to use.

To read one or more bytes, the master device addresses the unit with a write cycle (= 0) to send AHI followed by ALO, readdresses the unit with a read cycle (= 1), and reads one or more data bytes. Each data byte read increments the internal address counter by one up to the end of the EEPROM address space. A read or write beyond the end of the EEPROM address space must result in a NAK response by the Port Expander.

To write data to the EEPROM, the master device performs one write cycle, with the first two bytes being AHI followed by ALO. This is followed by one or more data bytes. In the case of block writing it is advisable to set the starting address on the beginning of the 64-byte boundary, for example 01C0h or 0080h, but this is not mandatory. When a 64-byte boundary is crossed in the EEPROM, the I²C clock is stretched while the device performs an EEPROM write sequence. If the end of available EEPROM space is reached, then further writes are responded to with a NAK.

Refer to [Figure 6 on page 10](#), which illustrates memory reading and writing procedures for the EEPROM device.

Multi Port I/O Device

This device allows the user to set configurations and I/O operations through internal registers.

Each data transfer is preceded by the command byte. This byte is used as a pointer to a register that receives or transmits data. Available registers are listed in [Table 6 on page 11](#).

Pinouts

The CY8C95xxA device is available in a variety of packages, which are listed and illustrated in the following tables.

28-Pin Part Pinout

Table 3. 28-Pin Part Pinout (SSOP)

Pin No.	Pin Name	Description
1	GPort0_Bit0_PWM3	Port 0, Bit 0, PWM 3.
2	GPort0_Bit1_PWM1	Port 0, Bit 1, PWM 1.
3	GPort0_Bit2_PWM3	Port 0, Bit 2, PWM 3.
4	GPort0_Bit3_PWM1	Port 0, Bit 3, PWM 1.
5	GPort0_Bit4_PWM3	Port 0, Bit 4, PWM 3.
6	GPort0_Bit5_PWM1	Port 0, Bit 5, PWM 1.
7	GPort0_Bit6_PWM3	Port 0, Bit 6, PWM 3.
8	GPort0_Bit7_PWM1	Port 0, Bit 7, PWM 1.
9	V _{SS}	Ground connection.
10	I ² C Serial Clock (SCL)	I ² C Clock.
11	I ² C Serial Data (SDA)	I ² C Data.
12	GPort2_Bit3_PWM3/A1	Port 2, Bit 3, PWM 3, Address 1.
13	A0	Address 0.
14	V _{SS}	Ground connection.
15	GPort2_Bit2_PWM0/WD	Port 2, Bit 2, PWM 0, E ² Write Disable.
16	INT	
17	GPort2_Bit1_PWM0/A2	Port 2, Bit 1, PWM 0, Address 2.
18	GPort2_Bit0_PWM2/A3	Port 2, Bit 0, PWM 2, Address 3.
19	XRES	Active high external reset with internal pull down.
20	GPort1_Bit7_PWM0/A4	Port 1, Bit 7, PWM 0, Address 4.
21	GPort1_Bit6_PWM2/A5	Port 1, Bit 6, PWM 2, Address 5.
22	GPort1_Bit5_PWM0/A6	Port 1, Bit 5, PWM 0, Address 6.
23	GPort1_Bit4_PWM2	Port 1, Bit 4, PWM 2.
24	GPort1_Bit3_PWM0	Port 1, Bit 3, PWM 0.
25	GPort1_Bit2_PWM2	Port 1, Bit 2, PWM 2.
26	GPort1_Bit1_PWM0	Port 1, Bit 1, PWM 0.
27	GPort1_Bit0_PWM2	Port 1, Bit 0, PWM 2.
28	V _{DD}	Supply voltage.

Figure 2. CY8C9520A 28-Pin Device



48-Pin Part Pinout

Table 4. 48-Pin Part Pinout (SSOP)

Pin No.	Pin Name	Description
1	GPort0_Bit0_PWM7	Port 0, Bit 0, PWM 7.
2	GPort0_Bit1_PWM5	Port 0, Bit 1, PWM 5.
3	GPort0_Bit2_PWM3	Port 0, Bit 2, PWM 3.
4	GPort0_Bit3_PWM1	Port 0, Bit 3, PWM 1.
5	GPort0_Bit4_PWM7	Port 0, Bit 4, PWM 7.
6	GPort0_Bit5_PWM5	Port 0, Bit 5, PWM 5.
7	GPort0_Bit6_PWM3	Port 0, Bit 6, PWM 3.
8	GPort0_Bit7_PWM1	Port 0, Bit 7, PWM 1.
9	GPort3_Bit0_PWM7	Port 3, Bit 0, PWM 7.
10	GPort3_Bit1_PWM5	Port 3, Bit 1, PWM 5.
11	GPort3_Bit2_PWM3	Port 3, Bit 2, PWM 3.
12	GPort3_Bit3_PWM1	Port 3, Bit 3, PWM 1.
13	V _{SS}	Ground connection.
14	GPort3_Bit4_PWM7	Port 3, Bit 4, PWM 7.
15	GPort3_Bit5_PWM5	Port 3, Bit 5, PWM 5.
16	GPort3_Bit6_PWM3	Port 3, Bit 6, PWM 3.
17	GPort3_Bit7_PWM1	Port 3, Bit 7, PWM 1.
18	GPort5_Bit2_PWM3	Port 5, Bit 2, PWM 3.
19	GPort5_Bit3_PWM1	Port 5, Bit 3, PWM 1.
20	I ² C Serial Clock (SCL)	I ² C Clock.
21	I ² C Serial Data (SDA)	I ² C Data.
22	GPort2_Bit3_PWM3/A1	Port 2, Bit 3, PWM 3, Address 1.
23	A0	Address 0.
24	V _{SS}	Ground connection.
25	GPort2_Bit2_PWM0/WD	Port 2, Bit 2, PWM 0, E ² Write Disable.
26	INT	
27	GPort2_Bit1_PWM4/A2	Port 2, Bit 1, PWM 4, Address 2.
28	GPort2_Bit0_PWM6/A3	Port 2, Bit 0, PWM 6, Address 3.
29	GPort5_Bit1_PWM0	Port 5, Bit 1, PWM 0.
30	GPort5_Bit0_PWM2	Port 5, Bit 0, PWM 2.
31	GPort4_Bit7_PWM0	Port 4, Bit 7, PWM 0.
32	GPort4_Bit6_PWM2	Port 4, Bit 6, PWM 2.
33	GPort4_Bit5_PWM4	Port 4, Bit 5, PWM 4.
34	GPort4_Bit4_PWM6	Port 4, Bit 4, PWM 6.
35	XRES	Active high external reset with internal pull down.
36	GPort4_Bit3_PWM0	Port 4, Bit 3, PWM 0.
37	GPort4_Bit2_PWM2	Port 4, Bit 2, PWM 2.
38	GPort4_Bit1_PWM4	Port 4, Bit 1, PWM 4.
39	GPort4_Bit0_PWM6	Port 4, Bit 0, PWM 6.
40	GPort1_Bit7_PWM0/A4	Port 1, Bit 7, PWM 0, Address 4.
41	GPort1_Bit6_PWM2/A5	Port 1, Bit 6, PWM 2, Address 5.
42	GPort1_Bit5_PWM4/A6	Port 1, Bit 5, PWM 4, Address 6.
43	GPort1_Bit4_PWM6	Port 1, Bit 4, PWM 6.
44	GPort1_Bit3_PWM0	Port 1, Bit 3, PWM 0.
45	GPort1_Bit2_PWM2	Port 1, Bit 2, PWM 2.
46	GPort1_Bit1_PWM4	Port 1, Bit 1, PWM 4.
47	GPort1_Bit0_PWM6	Port 1, Bit 0, PWM 6.
48	V _{DD}	Supply voltage.

Figure 3. CY8C9540A 48-Pin Device



100-Pin Part Pinout

Table 5. 100-Pin Part Pinout (TQFP)

Pin No.	Name	Description	Pin No.	Name	Description
1	DNU	DNU = Do Not Use; leave floating.	51	DNU	DNU = Do Not Use; leave floating.
2	DNU	DNU = Do Not Use; leave floating.	52	GPort5_Bit1_PWM8	Port 5, Bit 1, PWM 8.
3	GPort0_Bit3_PWM1	Port 0, Bit 3, PWM 1.	53	GPort5_Bit0_PWM10	Port 5, Bit 0, PWM 10.
4	GPort0_Bit4_PWM7	Port 0, Bit 4, PWM 7.	54	GPort5_Bit4_PWM12	Port 5, Bit 4, PWM 12.
5	GPort0_Bit5_PWM5	Port 0, Bit 5, PWM 5.	55	GPort5_Bit5_PWM14	Port 5, Bit 5, PWM 14.
6	GPort0_Bit6_PWM3	Port 0, Bit 6, PWM 3.	56	GPort4_Bit7_PWM8	Port 4, Bit 7, PWM 8.
7	GPort0_Bit7_PWM1	Port 0, Bit 7, PWM 1.	57	GPort4_Bit6_PWM10	Port 4, Bit 6, PWM 10.
8	GPort3_Bit0_PWM7	Port 3, Bit 0, PWM 7.	58	GPort4_Bit5_PWM12	Port 4, Bit 5, PWM 12.
9	GPort3_Bit1_PWM5	Port 3, Bit 1, PWM 5.	59	GPort4_Bit4_PWM14	Port 4, Bit 4, PWM 14.
10	GPort3_Bit2_PWM3	Port 3, Bit 2, PWM 3.	60	DNU	DNU = Do Not Use; leave floating.
11	GPort3_Bit3_PWM1	Port 3, Bit 3, PWM 1.	61	DNU	DNU = Do Not Use; leave floating.
12	DNU	DNU = Do Not Use; leave floating.	62	XRES	Active high external reset with internal pull down.
13	DNU	DNU = Do Not Use; leave floating.	63	GPort4_Bit3_PWM0	Port 4, Bit 3, PWM 0.
14	DNU	DNU = Do Not Use; leave floating.	64	GPort4_Bit2_PWM2	Port 4, Bit 2, PWM 2.
15	V _{SS}	Ground connection.	65	V _{SS}	Ground connection.
16	GPort3_Bit4_PWM15	Port 3, Bit 4, PWM 15.	66	GPort4_Bit1_PWM4	Port 4, Bit 1, PWM 4.
17	GPort3_Bit5_PWM13	Port 3, Bit 5, PWM 13.	67	GPort4_Bit0_PWM6	Port 4, Bit 0, PWM 6.
18	GPort3_Bit6_PWM11	Port 3, Bit 6, PWM 11.	68	GPort1_Bit7_PWM0/A4	Port 1, Bit 7, PWM 0, Address 4.
19	GPort3_Bit7_PWM9	Port 3, Bit 7, PWM 9.	69	GPort1_Bit6_PWM2/A5	Port 1, Bit 6, PWM 2, Address 5.
20	GPort5_Bit7_PWM15	Port 5, Bit 7, PWM 15.	70	GPort1_Bit5_PWM4/A6	Port 1, Bit 5, PWM 4, Address 6.
21	GPort5_Bit6_PWM13	Port 5, Bit 6, PWM 13.	71	DNU	DNU = Do Not Use; leave floating.
22	GPort5_Bit2_PWM11	Port 5, Bit 2, PWM 11.	72	GPort1_Bit4_PWM6	Port 1, Bit 4, PWM 6.
23	GPort5_Bit3_PWM9	Port 5, Bit 3, PWM 9.	73	DNU	DNU = Do Not Use; leave floating.
24	I ² C Serial Clock (SCL)	I ² C Clock.	74	GPort1_Bit3_PWM0	Port 1, Bit 3, PWM 0.
25	DNU	DNU = Do Not Use; leave floating.	75	DNU	DNU = Do Not Use; leave floating.
26	DNU	DNU = Do Not Use; leave floating.	76	DNU	DNU = Do Not Use; leave floating.
27	DNU	DNU = Do Not Use; leave floating.	77	GPort1_Bit2_PWM2	Port 1, Bit 2, PWM 2.
28	I ² C Serial Data (SDA)	I ² C Data.	78	DNU	DNU = Do Not Use; leave floating.
29	GPort2_Bit3_PWM11/A1	Port 2, Bit 3, PWM 11, Address 1.	79	GPort1_Bit1_PWM4	Port 1, Bit 1, PWM 4.
30	A0	Address 0.	80	DNU	DNU = Do Not Use; leave floating.
31	DNU	DNU = Do Not Use; leave floating.	81	GPort1_Bit0_PWM6	Port 1, Bit 0, PWM 6.
32	V _{dd}	Supply voltage.	82	V _{dd}	Supply voltage.
33	DNU	DNU = Do Not Use; leave floating.	83	V _{dd}	Supply voltage.
34	V _{SS}	Ground connection.	84	V _{SS}	Ground connection.
35	DNU	DNU = Do Not Use; leave floating.	85	V _{SS}	Ground connection.
36	GPort7_Bit7_PWM15	Port 7, Bit 7, PWM 15.	86	GPort6_Bit0_PWM0	Port 6, Bit 0, PWM 0.
37	GPort7_Bit6_PWM14	Port 7, Bit 6, PWM 14.	87	GPort6_Bit1_PWM1	Port 6, Bit 1, PWM 1.
38	GPort7_Bit5_PWM13	Port 7, Bit 5, PWM 13.	88	GPort6_Bit2_PWM2	Port 6, Bit 2, PWM 2.
39	GPort7_Bit4_PWM12	Port 7, Bit 4, PWM 12.	89	GPort6_Bit3_PWM3	Port 6, Bit 3, PWM 3.
40	GPort7_Bit3_PWM11	Port 7, Bit 3, PWM 11.	90	GPort6_Bit4_PWM4	Port 6, Bit 4, PWM 4.
41	GPort7_Bit2_PWM10	Port 7, Bit 2, PWM 10.	91	GPort6_Bit5_PWM5	Port 6, Bit 5, PWM 5.
42	GPort7_Bit1_PWM9	Port 7, Bit 1, PWM 9.	92	GPort6_Bit6_PWM6	Port 6, Bit 6, PWM 6.
43	GPort7_Bit0_PWM8	Port 7, Bit 0, PWM 8.	93	GPort6_Bit7_PWM7	Port 6, Bit 7, PWM 7.
44	GPort2_Bit2_PWM8/WD	Port 2, Bit 2, PWM 8, E ² Write Disable.	94	DNU	DNU = Do Not Use; leave floating.
45	INT		95	GPort0_Bit0_PWM7	Port 0, Bit 0, PWM 7.
46	GPort2_Bit1_PWM12/A2	Port 2, Bit 7, PWM 0, Address 4.	96	DNU	DNU = Do Not Use; leave floating.
47	GPort2_Bit0_PWM14/A3	Port 2, Bit 6, PWM 2, Address 5.	97	GPort0_Bit1_PWM5	Port 0, Bit 1, PWM 5.
48	DNU	DNU = Do Not Use; leave floating.	98	DNU	DNU = Do Not Use; leave floating.
49	DNU	DNU = Do Not Use; leave floating.	99	GPort0_Bit2_PWM3	Port 0, Bit 2, PWM 3.
50	DNU	DNU = Do Not Use; leave floating.	100	DNU	DNU = Do Not Use; leave floating.

Figure 4. CY8C9560A 100-Pin Device^[2]

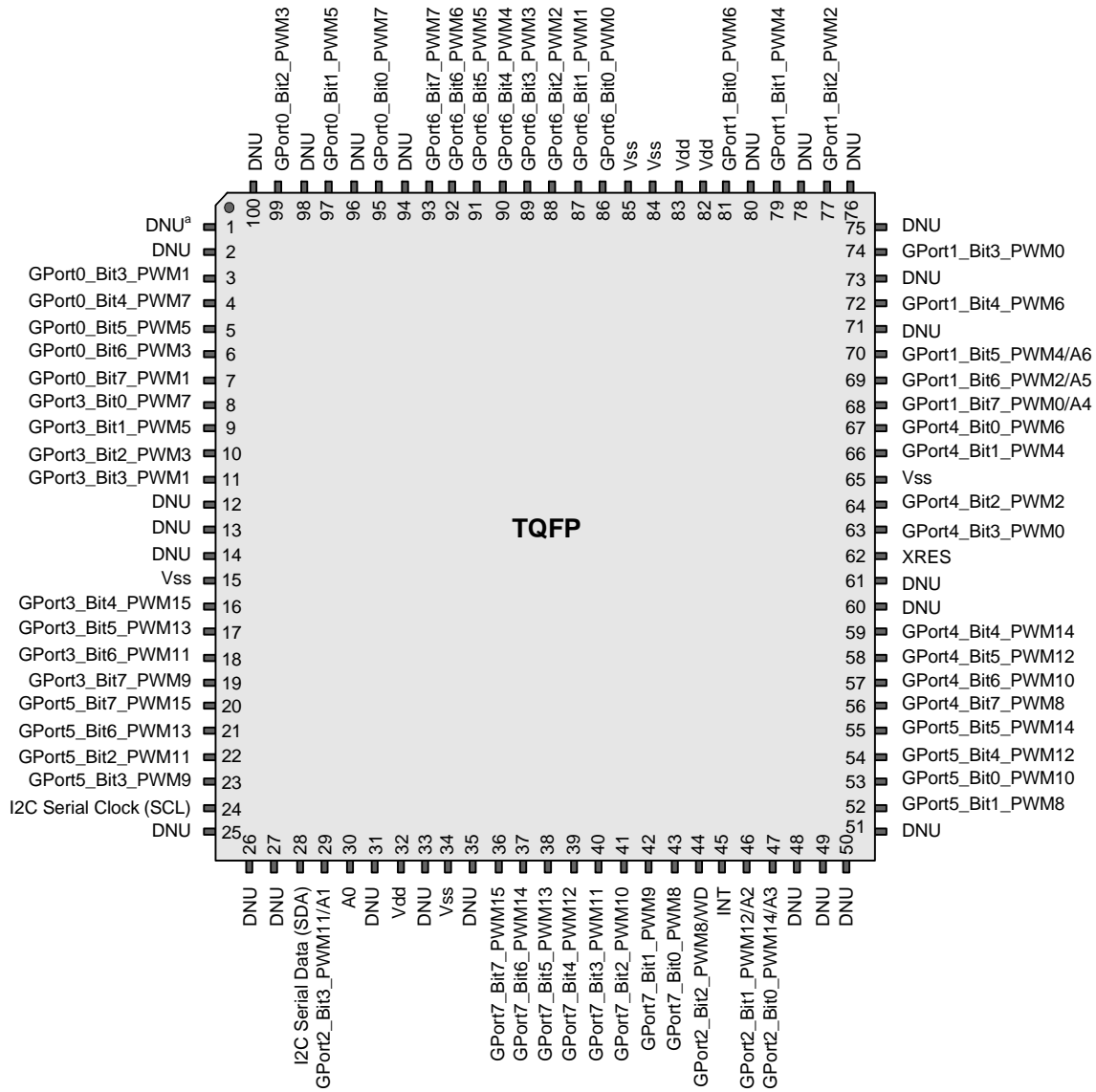

Note
 2. DNU = Do Not Use; leave floating.

Pin Descriptions

Extendable Soft Addressing

The A0 line defines the corresponding bit of the I²C address. This pin must be pulled up or down. If A0 is a strong pull up or a strong pull down (wired through 330 or less resistor to Vdd or Vss), then that is the only address line being specified and the A1-A6 lines are used as GPIO. If A0 is a weak pull up or a weak pull down (connected to Vdd or Vss through 75K- 200K ohm resistor), then A0 is not the only externally defined address bit. There is a pin assigned to be A1 if it is needed. This pin can be pulled up or pulled down strong or weak with a resistor. As with A0, the type of pull determines whether the address bit is the last externally defined address bit. Differently from A0, A1 is not dedicated as an address pin. It is only used if A0 is not the only address bit externally defined. There are also predefined pins for A2, A3, A4, A5, and A6 that is only used for addressing if needed. The last address bit in the chain is pulled strong. That way, only the number of pins needed to assign the address desired for the part are allocated as address pins, any pins not used for address bits can be used as GPIO pins. The [Table 2 on page 4](#) defines the resulting device I²C address.

Note: It is not recommended to share pull up/down resistors between multiple devices.

Interrupt Pin (INT)

The interrupt output (if enabled) is activated if one of these events occurs:

- One of the GPIO port pins changes state and the corresponding bit in the Interrupt Mask register is set low.
- When a PWM driven by the slowest clock source (367.6 Hz) and assigned to a pin changes state and the pin's corresponding bit in the Interrupt Mask register is set low.

The interrupt line is deactivated when the master device performs a read from the corresponding Interrupt Status register. The INT output is active high output and the drive mode of this pin is strong drive mode.

Write Disable Pin (WD)

If this feature is enabled, '0' allows writes to the EEPROM and '1' blocks any memory writes. This pin is checked immediately before performing any write to memory. If the EEE bit in the Enable register is not set (EEPROM disabled) or bit EERO is set (EEPROM is read-only) then WD line level is ignored.

Note that '1' on this line blocks all commands that perform operations with EEPROM (see [Table 14 on page 14](#)).

This line may be enabled/disabled by bit 1 of the Enable register (2Dh): '1' enables WD function, '0' disables.

External Reset Pin (XRES)

A full device reset is caused by pulling the XRES pin high. The XRES pin has an always-on pull down resistor, so it does not require an external pull down for operation. It can be tied directly to ground or left open. Behavior after XRES is similar to

POR. When the part is held in reset, all In and Out pins are held at their default High-Z State.

Working with PWMs

There are four independent PWMs in the CY8C9520A, eight in the CY8C9540A and sixteen in the CY8C9560A. Each I/O pin can be configured as a PWM output by writing '1' to the corresponding bit of the Select PWM register (see [Table 7 on page 12](#)).

The next step of PWM configuration is clock source selection using the Config PWM registers. There are six available clock sources: 32 kHz (default), 24 MHz, 1.5 MHz, 93.75 kHz, 367.6 Hz or previous PWM output. (see [Figure 5](#))

Figure 5. Clock Sources

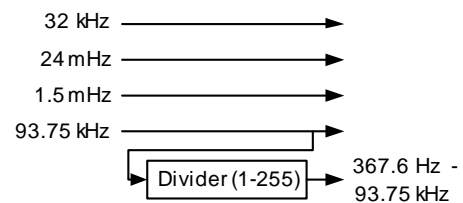

By default, 32 kHz is selected as the PWM clock.

PWM Period registers are used to set the output period:

$$t_{OUT} = Period \times t_{CLK}$$

Allowed values are between 1 and FFh.

The PWM Pulse Width register sets the duration of the PWM output pulse. Allowed values are between zero and the (Period-1) value. The duty cycle ratio is computed using this equation:

$$DutyCycle = \frac{PulseWidth}{Period}$$

Figure 6. Memory Reading and Writing

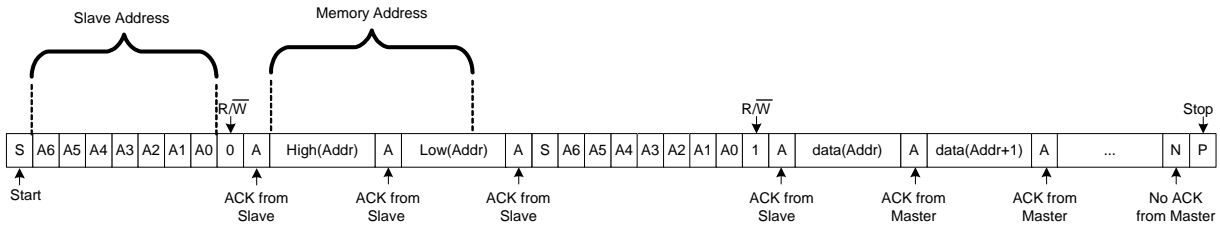

Reading from EEPROM

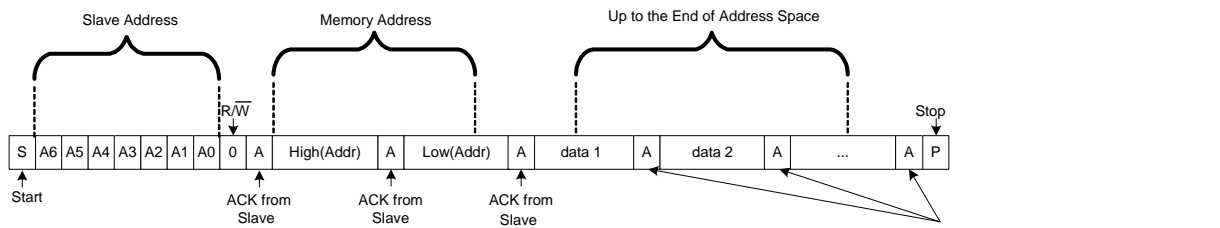

Writing to EEPROM

Figure 7. Port Reading and Writing in Multi-Port Device

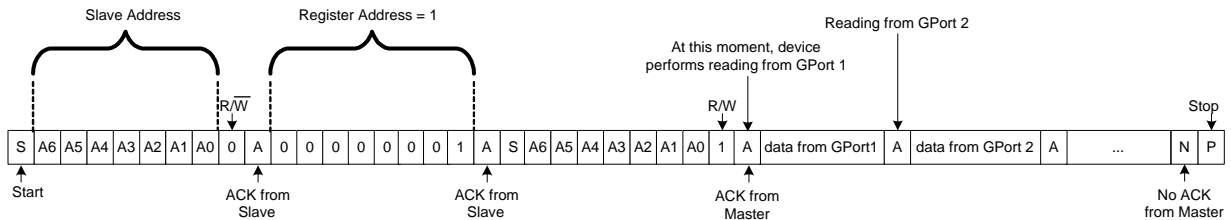

Reading from GPort 1

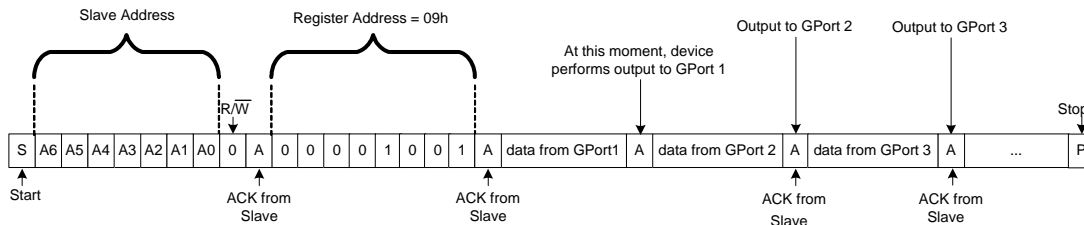

Writing from GPort 1

Register Mapping Table

The register address is auto-incrementing. If the master device writes or reads data to or from one register and then continues data transfer in the same I²C transaction, sequential bytes are written or read to or from the following registers. For example, if the first byte is sent to the Output Port 1 register, then the next bytes are written to Output Port 2, Output Port 3, Output Port 4 etc. The first byte of each write transaction is treated as the register address.

To read data from a series of registers, the master device must write the starting register address byte then perform a start and series of read transactions. If no address was sent, reads start from address 0.

To read a specific register address, the master device must write the register address byte, then perform a start and read transaction.

See [Figure 7 on page 10](#).

The device's register mapping is listed in [Table 6](#).

Table 6. The Device Register Address Map

Address	Register	Default Register Value
00h	Input Port 0	None
01h	Input Port 1	None
02h	Input Port 2	None
03h	Input Port 3	None
04h	Input Port 4	None
05h	Input Port 5	None
06h	Input Port 6	None
07h	Input Port 7	None
08h	Output Port 0	FFh
09h	Output Port 1	FFh
0Ah	Output Port 2	FFh
0Bh	Output Port 3	FFh
0Ch	Output Port 4	FFh
0Dh	Output Port 5	FFh
0Eh	Output Port 6	FFh
0Fh	Output Port 7	FFh
10h	Interrupt Status Port 0	00h
11h	Interrupt Status Port 1	00h
12h	Interrupt Status Port 2	00h
13h	Interrupt Status Port 3	00h
14h	Interrupt Status Port 4	00h
15h	Interrupt Status Port 5	00h
16h	Interrupt Status Port 6	00h
17h	Interrupt Status Port 7	00h
18h	Port Select	00h
19h	Interrupt Mask	FFh

Table 6. The Device Register Address Map (continued)

Address	Register	Default Register Value
1Ah	Select PWM for Port Output	00h
1Bh	Inversion	00h
1Ch	Pin Direction - Input/Output	00h
1Dh	Drive Mode - Pull Up	FFh
1Eh	Drive Mode - Pull Down	00h
1Fh	Drive Mode - Open Drain High	00h
20h	Drive Mode - Open Drain Low	00h
21h	Drive Mode - Strong	00h
22h	Drive Mode - Slow Strong	00h
23h	Drive Mode - High-Z	00h
24h	Reserved	None
25h	Reserved	None
26h	Reserved	None
27h	Reserved	None
28h	PWM Select	00h
29h	Config PWM	00h
2Ah	Period PWM	FFh
2Bh	Pulse Width PWM	80h
2Ch	Programmable Divider	FFh
2Dh	Enable WDE, EEE, EERO	00h
2Eh	Device ID/Status	20h/40h/60h
2Fh	Watchdog	00h
30h	Command	00h

Register Descriptions

The registers for the CY8C95xx are described in the sections that follow. Note that the PWM registers are located at addresses 28h to 2Bh.

Input Port Registers (00h–07h)

These registers represent actual logical levels on the pins and are used for I/O port reading operations. They are read only. The Inversion registers changes the state of reads to these ports.

Output Port Registers (08h–0Fh)

These registers are used for writing data to GPIO ports. By default, all ports are in the pull up mode allowing quasi-bidirectional I/O. To allow input operations without reconfiguration, these registers have to store '1's.

Output register data also affects pin states when PWMs are enabled. See [Table 7 on page 12](#) for details.

See [Figure 7 on page 10](#) illustrates port read/write procedures.

The Inversion registers have no effect on these ports.

Int. Status Port Registers (10h–17h)

Each '1' bit in these registers signals that there was a change in the corresponding input line since the last read of that Interrupt Status register. Each Interrupt (Int.) Status register is cleared only after a read of that register.

If a PWM is assigned to a pin, then all state changes of the PWM sets the corresponding bit in the Interrupt Status register. If the pin's interrupt mask is cleared and the PWM is set to the slowest possible rate allowed (driven by the programmable clock source with divide register 2Dh set to FFh), then the INT line also drives on the PWM state change.

Port Select Register (18h)

This register configures the GPort. Write a value of 0–7 to this register to select the port to program with registers 19h–23h.

Interrupt Mask Port Register (19h)

The Interrupt Mask register enables or disables activation of the INT line when GPIO input levels are changed. Each '1' in the Interrupt Mask register masks (disables) interrupts generated from the corresponding input line of the GPort selected by the Port Select register (18h).

Select PWM Register (1Ah)

This register allows each port to act as a PWM output. By default, all ports are configured as GPIO lines. Each '1' in this register connects the corresponding pin of the GPort selected by the Port Select register (18h) to the PWM output. Output register data also affects the pin state when a PWM is enabled. See [Table 7](#).

Note that a pin used as PWM output must be configured to the appropriate drive mode. See [Table 9](#) for more information.

[Table 7](#) describes the logic of the Output and Select PWM registers.

Table 7. Output and Select PWM Registers Logic

Output	Select PWM	Pin State
0	0	0
1	0	1
0	1	0
1	1	Current PWM

Inversion Register (1Bh)

This register can invert the logic of the input ports. Each '1' written to this register inverts the logic of the corresponding bit in the Input register of the GPort selected by the Port Select register (18h).

The Input registers' logic is presented in [Table 8](#). These registers have no effect on outputs or PWMs.

Table 8. Inversion Register Logic

Pin State	Invert	Input
0	0	0
1	0	1
0	1	1
1	1	0

Port Direction Register (1Ch)

Each bit in a port is configurable as either an input or an output. To perform this configuration, the Port Direction register (1Ch) is used for the GPort selected by the Port Select register (18h). If a bit in this register is set (written with '1'), the corresponding port pin is enabled as an input. If a bit in this register is cleared (written with '0'), the corresponding port pin is enabled as an output.

Drive Mode Registers (1Dh–23h)

Each port's data pins can be set separately to one of seven available modes: pull up or down, open drain high/low, strong drive fast/slow, or high-impedance input. To perform this configuration, the seven drive mode registers are used for the GPort selected by the Port Select register (18h). Each '1' written to this register changes the corresponding line drive mode. Registers 1Dh through 23h have last register priority meaning that the bit set to high in which the last register was written overrides those that came before. Reading these registers reflects the actual setting, not what was originally written.

Table 9. Drive Mode Register Settings

Reg.	Pin State	Description
1Dh	Resistive Pull Up	Resistive High, Strong Low (default)
1Eh	Resistive Pull Down	Strong High, Resistive Low
1Fh	Open Drain High	Slow Strong High, High Z Low
20h	Open Drain Low	Slow Strong Low, High Z High
21h	Strong Drive	Strong High, Strong Low, Fast Output Mode
22h	Slow Strong Drive	Strong High, Strong Low, Slow Output Mode
23h	High Impedance	High Z

PWM Select Register (28h)

This register is configured the PWM. Write a value of 00h-0Fh to this register to select the PWM to program with registers 29h-2Bh.

Config (29h)

This register selects the clock source for the PWM selected by the PWM Select register (28h) and interrupt logic.

There are six available clock sources: 32 kHz (default), 24 MHz, 1.5 MHz, 93.75 kHz, 367.6 Hz, or previous PWM output. The 367.6 Hz clock is user programmable. It divides the 93.75 kHz clock source by the divisor stored in the Divider register (2Ch). The default divide ratio is 255. (see Table 10 for details). By default, all PWMs are clocked from 32 kHz.

Table 10. PWM Clock Sources

Config PWM	PWM Clock Source
xxxx000b	32 kHz (default)
xxxx001b	24 MHz
xxxx010b	1.5 MHz
xxxx011b	93.75 kHz
xxxx100b	367.6 Hz (programmable)
xxxx101b	Previous PWM

Each PWM can generate an interrupt at the rising or falling edge of the output pulse. There is a limitation on the clock source for a PWM to generate an interrupt. Only the slowest speed source (programmed to 367.6 Hz) with the divider equal to 255 allows interrupt generation. Consequently, to create a PWM interrupt, it is necessary to choose the programmable divider output as the clock source (write xxxx100b to Config register (29h)), write 255 to the Divide register (2Ch), and select PWM for pin output (1Ah).

Interrupt status is reflected in the Interrupt Status registers (10h-17h) and can cause INT line activation if enabled by the corresponding mask bit in the Interrupt Mask register.

Period Register (2Ah)

Table 11. Period Register

Config PWM	PWM Interrupt on
xxx0xxx	Falling pulse edge (default)
xxx1xxx	Rising pulse edge

This register sets the period of the PWM counter. Allowed values are between 1 and FFh. The effective output waveform period of the PWM is:

$$t_{OUT} = Period \cdot t_{CLK}$$

Pulse Width Register (2Bh)

This register sets the pulse width of the PWM output. Allowed values are between zero and the (Period - 1) value. The duty cycle ratio can be computed using the following equation:

$$DutyCycle = \frac{PulseWidth}{Period}$$

Divider Register (2Ch)

This register sets the frequency on the output of the programmable divider:

$$Frequency = \frac{93.75 \text{ kHz}}{Divider}$$

Allowed values are between 1 and 255.

Enable Register (2Dh)

The WDE bit configures the write disable pin to operate either as a GPIO or as WD. It also enables/disables EEPROM operations (EEE bit) or makes the EEPROM read-only (EERO bit). Bit assignments are shown in Table 12 on page 13.

Table 12. Enable Register

Bit	7	6	5	4	3	2	1	0
Function	Reserved					EERO	EEE	WDE
Default	Reserved					0	0	0

Each '1' enables the corresponding feature, '0' disables.

Writes to this register differ from other registers. The write sequence to modify the Enable register is as follows:

1. Send device I²C address with bit 0.
2. Send register address 2Dh.
3. Send unlock key - the sequence of three bytes: 43h, 4Dh, 53h; ('C', 'M', 'S' in ASCII bytes).
4. Send new Enable register value.

This write sequence secures the register from accidental changes. The register can be read without the use of the unlock key.

By default, EERO and EEPROM (EEE bit) are disabled and WD line (WDE bit) is set to GPIO (WD disabled).

When performing a burst write operation that crosses this register, the data written to this register is ignored and the address increments to 2Eh.

Device ID/Status Register (2Eh)

This register stores device identifiers (2xh/4xh/6xh) and reflects which settings were loaded during startup, either factory defaults (FD) or user defaults (UD). By default during startup, the device attempts to load the user default block. If it is corrupted then factory defaults are loaded and the low nibble of this register is set high to inform which set is active. The high nibble is always equal to 2 for CY8C9520A, 4 for CY8C9540A, and 6 for CY8C9560A.

This register is read-only.

Table 13. Device ID Status Register

Bit	7	6	5	4	3	2	1	0
Function	Device Family (2, 4, or 6)				Reserved			FD/UD

Watchdog Register (2Fh)

This register controls the internal Watchdog timer. This timer can trigger a device reset if the device is not responding to I²C requests due to misconfiguration. Device operation is not affected when the Watchdog register = 0. If the I²C master writes any non zero value to the Watchdog register, the countdown mechanism is activated and each second the register is decremented. Upon transition from 1 to 0, the device is rebooted, which restores user defaults. After reboot, the Watchdog register value is reset to zero. Any I²C transaction (addressing the Expander) resets the Watchdog register to the previously stored value. Any device reboot (caused by a POR or Watchdog) sets the Watchdog register to zero (turns off the Watchdog feature). The Watchdog timer can be disabled by writing zero to the Watchdog register (2Fh) or by using the Reconfigure Device Cmd (07h).

Note The Watchdog timer is not intended to track precise time intervals. The timer's frequency can vary in range between -50% on up to +100%. This variation must be taken into account when selecting the appropriate value for the Watchdog register.

Command Register (30h)

This register sends commands to the device, including current configuration as new POR defaults, restore factory defaults, define POR defaults, read POR defaults, write device configuration, read device configuration, and reconfigure device with stored POR defaults. The command set is presented in Table 14.

Note Registers are not restored in parallel. Do not assume any particular order to the restoration process.

Table 14. Available Commands

Command	Description
01h	Store device configuration to EEPROM POR defaults
02h	Restore Factory Defaults
03h	Write EEPROM POR defaults
04h	Read EEPROM POR defaults
05h	Write device configuration
06h	Read device configuration
07h	Reconfigure device with stored POR defaults

Commands Description

Store Config to E² POR Defaults Cmd (01h)

The current ports settings (drive modes and output data) and other configuration registers are saved in the EEPROM by using the store configuration command (Cmd). These settings are automatically loaded after the next device power up or if the 07h command is issued.

Restore Factory Defaults Cmd (02h)

This command replaces the saved user configuration with the factory default configuration. Current settings are unaffected by this command. New settings are loaded after the next device power up or if the 07h command is issued.

Write E² POR Defaults Cmd (03h)

This command sends new power up defaults to the CY8C95xx without changing current settings unless the 07h command is issued afterwards. This command is followed by 147 data bytes according to Table 15. The CRC is calculated as the XOR of the 146 data bytes (00h-91h). If the CRC check fails or an incomplete block is sent, then the slave responds with a NAK and the data does not get saved to EEPROM.

To define new POR defaults the user must:

- Write command 03h
- Write 146 data bytes with new values of registers
- Write 1 CRC byte calculated as XOR of previous 146 data bytes.

Content of the data block is described in Table 15.

Table 15. POR Defaults Data Structure

Offset	Value
00h–07h	Output Port 0–7
08h–0Fh	Interrupt mask Port 0–7
10h–17h	Select PWM Port 0–7
18h–1Fh	Inversion Port 0–7
20h–27h	Pin Direction Port 0–7
28h	Resistive pull up Drive Mode Port 0
29h	Resistive pull down Drive Mode Port 0
2Ah	Open drain high Drive Mode Port 0
2Bh	Open drain low Drive Mode Port 0
2Ch	Strong drive Drive Mode Port 0
2Dh	Slow strong drive Drive Mode Port 0
2Eh	High impedance Drive Mode Port 0
2Fh–35h	Drive Modes Port 1
36h–3Ch	Drive Modes Port 2
3Dh–43h	Drive Modes Port 3
44h–4Ah	Drive Modes Port 4
4Bh–51h	Drive Modes Port 5
52h–58h	Drive Modes Port 6
59h–5Fh	Drive Modes Port 7
60h	Config setting PWM0
61h	Period setting PWM0
62h	Pulse Width setting PWM0
63h–65h	PWM1 settings
...	...
8Dh–8Fh	PWM15 settings
90h	Divider
91h	Enable
92h	CRC

Read E2 POR Defaults Cmd (04h)

This command reads the POR settings stored in the EEPROM.

To read POR defaults the user must:

- Write command 04h
- Read 146 data bytes (see [Table 15 on page 14](#))
- Read 1 CRC byte.

Write Device Config Cmd (05h)

This command sends a new device configuration to the CY8C95xx. It is followed by 146 data bytes according to [Table 15](#). The CRC is calculated as the XOR of the 146 data bytes (00h-91h). If the CRC check fails or an incomplete block is sent, then the slave responds with a NAK and the device does not use the data. This gives the user 'flat-address-space' access to all device settings.

To set the current device configuration the user must:

- Write command 05h
- Write 146 data bytes with new values of registers
- Write 1 CRC byte calculated as XOR of previous 146 data bytes.

If the CRC check passes, then the device uses the new settings immediately.

Content of the data block is described in [Table 15 on page 14](#).

Read Device Config Cmd (06h)

This command reads the current device configuration. It gives the user 'flat-address-space' access to all device settings.

To read device configuration the user must:

- Write command 06h
- Read 146 data bytes (see [Table 15 on page 14](#)).
- Read 1 CRC byte.

Reconfigure Device Cmd (07h)

This command immediately reconfigures the device with actual POR defaults from EEPROM. It has the same effect on the registers as a POR.

Electrical Specifications

This section lists the DC and AC electrical specifications of the CY8C95xxA device. For the most up to date electrical specifications, confirm that you have the most recent data sheet by going to the web at <http://www.cypress.com>.

Specifications are valid for $-40\text{ }^{\circ}\text{C} \leq T_A \leq 85\text{ }^{\circ}\text{C}$ and $T_J \leq 100\text{ }^{\circ}\text{C}$, except where noted.

Absolute Maximum Ratings

Table 16. Absolute Maximum Ratings

Symbol	Description	Min	Typ	Max	Units	Notes
T _{STG}	Storage temperature	-55	25	+100	°C	Higher storage temperatures reduces data retention time. Recommended storage temperature is +25 °C ± 25 °C. Extended duration storage temperatures above 65°C degrades reliability.
T _{BAKETEMP}	Bake Temperature	-	125	See package label	°C	
T _{BAKETIME}	Bake Time	See package label	-	72	Hours	
T _A	Ambient temperature with power applied	-40	-	+85	°C	
V _{dd}	Supply voltage on Vdd relative to Vss	-0.5	-	+6.0	V	
V _{IO}	DC input voltage	Vss - 0.5	-	Vdd + 0.5	V	
V _{IOZ}	DC voltage applied to tri-state	Vss - 0.5	-	Vdd + 0.5	V	
I _{MIO}	Maximum current into any port pin	-25	-	+50	mA	
ESD	Electro Static Discharge Voltage	2000	-	-	V	Human Body Model ESD.
LU	Latch up current	-	-	200	mA	

Operating Temperature

Table 17. Operating Temperature

Symbol	Description	Min	Typ	Max	Units	Notes
T _A	Ambient temperature	-40	-	+85	°C	
T _J	Junction temperature	-40	-	+100	°C	The temperature rise from ambient to junction is package specific. See "Thermal Impedances per Package" on page 23. The user must limit the power consumption to comply with this requirement.

DC Electrical Characteristics

DC Chip-Level Specifications

Table 18 lists guaranteed maximum and minimum specifications for the voltage and temperature ranges: 4.75 V to 5.25 V and $-40\text{ }^{\circ}\text{C} \leq T_A \leq 85\text{ }^{\circ}\text{C}$, or 3.0 V to 3.6 V and $-40\text{ }^{\circ}\text{C} \leq T_A \leq 85\text{ }^{\circ}\text{C}$, respectively. Typical parameters apply to 5 V and 3.3 V at 25 °C and are for design guidance only.

Table 18. CY8C9520A DC Chip-Level Specifications

Symbol	Description	Min	Typ	Max	Units	Notes
V _{DD}	Supply voltage	3.00	–	5.25	V	
I _{DD}	Supply current V _{DD} 5 V	–	3.8	5	mA	Conditions are 5.0 V, T _A = 25 °C, I _{OH} = 0.
I _{DD3}	Supply current V _{DD} 3.3 V	–	2.3	3	mA	Conditions are 3.3 V, T _A = 25 °C, I _{OH} = 0.

Table 19. CY8C9540A DC Chip-Level Specifications

Symbol	Description	Min	Typ	Max	Units	Notes
V _{DD}	Supply voltage	3.00	–	5.25	V	
I _{DD}	Supply current V _{DD} 5 V	–	6	9	mA	Conditions are 5.0 V, T _A = 25 °C, I _{OH} = 0.
I _{DD3}	Supply current V _{DD} 3.3 V	–	3.3	6	mA	Conditions are 3.3 V, T _A = 25 °C, I _{OH} = 0.

Table 20. CY8C9560A DC Chip-Level Specifications

Symbol	Description	Min	Typ	Max	Units	Notes
V _{DD}	Supply voltage	3.00	–	5.25	V	
I _{DD}	Supply current V _{DD} 5 V	–	15	25	mA	Conditions are 5.0 V, T _A = 25 °C, I _{OH} = 0.
I _{DD3}	Supply current V _{DD} 3.3 V	–	5	9	mA	Conditions are 3.3 V, T _A = 25 °C, I _{OH} = 0.

DC Programming Specifications

The following table lists guaranteed maximum and minimum specifications for the voltage and temperature ranges: 4.75 V to 5.25 V and $-40\text{ }^{\circ}\text{C} \leq T_A \leq 85\text{ }^{\circ}\text{C}$, or 3.0 V to 3.6 V and $-40\text{ }^{\circ}\text{C} \leq T_A \leq 85\text{ }^{\circ}\text{C}$, respectively. Typical parameters apply to 5 V and 3.3 V at 25 °C and are for design guidance only.

Table 21. DC Programming Specifications

Symbol	Description	Min	Typ	Max	Units	Notes
Flash _{ENPB}	Flash (EEPROM) endurance (by block)	10,000	–	–	–	Erase/write cycles by block.
Flash _{ENT}	Flash endurance (total) ^[3]	1,800,000	–	–	–	Erase/write cycles.
Flash _{DR}	Flash data retention	10	–	–	Years	

DC I²C Specifications

Table 22 lists guaranteed maximum and minimum specifications for the voltage and temperature ranges: 4.75 V to 5.25 V and $-40\text{ }^{\circ}\text{C} \leq T_A \leq 85\text{ }^{\circ}\text{C}$, or 3.0 V to 3.6 V and $-40\text{ }^{\circ}\text{C} \leq T_A \leq 85\text{ }^{\circ}\text{C}$, respectively. Typical parameters apply to 5 V and 3.3 V at 25 °C and are for design guidance only.

Table 22. DC I²C Specifications^[4]

Symbol	Description	Min	Typ	Max	Units	Notes
V _{IL} I ₂ C	Input low level	–	–	0.3 × V _{DD}	V	3.0 V ≤ V _{DD} ≤ 3.6 V
		–	–	0.25 × V _{DD}	V	4.75 V ≤ V _{DD} ≤ 5.25 V
V _{IH} I ₂ C	Input high level	0.7 × V _{DD}	–	–	V	3.0 V ≤ V _{DD} ≤ 5.25 V

Note

- A maximum of 180 x 10,000 block endurance cycles is allowed. This may be balanced between operations on 180x1 blocks of 10,000 maximum cycles each, 180x2 blocks of 5,000 maximum cycles each, or 180x4 blocks of 2,500 maximum cycles each (to limit the total number of cycles to 180x10,000 and that no single block ever sees more than 10,000 cycles).
- All GPIO meet the DC GPIO VIL and VIH specifications found in the DC GPIO Specifications sections. The I²C GPIO pins also meet the above specs.

DC GPIO Specifications

The following table lists guaranteed maximum and minimum specifications for the voltage and temperature ranges: 4.75 V to 5.25 V and $-40\text{ }^{\circ}\text{C} \leq T_A \leq 85\text{ }^{\circ}\text{C}$, or 3.0 V to 3.6 V and $-40\text{ }^{\circ}\text{C} \leq T_A \leq 85\text{ }^{\circ}\text{C}$, respectively. Typical parameters apply to 5 V and 3.3 V at 25 °C and are for design guidance only.

Table 23. DC GPIO Specifications

Symbol	Description	Min	Typ	Max	Units	Notes
V_{OH}	High output level	$V_{dd} - 1.0$	–	–	V	$I_{OH} = 10\text{ mA}$ for any one pin, $V_{dd} = 4.75\text{ to }5.25\text{ V}$. 40 mA maximum combined I_{OH} for GPort0; GPort2_Bit3; GPort3; GPort5_Bit2, 3, 6, 7; GPort6. 40 mA maximum combined I_{OH} for GPort1; GPort2_Bit0, 1, 2; GPort4; GPort5_Bit0, 1, 4, 5; GPort7. 80 mA maximum combined I_{OH} .
V_{OL}	Low output level	–	–	0.75	V	$I_{OL} = 25\text{ mA}$ for any one pin, $V_{dd} = 4.75\text{ to }5.25\text{ V}$. 100 mA maximum combined I_{OL} for GPort0; GPort2_Bit3; GPort3; GPort5_Bit2, 3, 6, 7; GPort6. 100 mA maximum combined I_{OL} for GPort1; GPort2_Bit0, 1, 2; GPort4; GPort5_Bit0, 1, 4, 5; GPort7. 200 mA maximum combined I_{OL} .
I_{OH}	High Level Source Current	10	–	–	mA	$V_{OH} = V_{dd} - 1.0\text{ V}$, see the limitations of the total current in the note for V_{OH}
I_{OL}	Low Level Sink Current	25	–	–	mA	$V_{OL} = 0.75\text{ V}$, see the limitations of the total current in the note for V_{OL}
V_{IL}	Input low level	–	–	0.8	V	$V_{dd} = 3.0\text{ to }5.5$.
V_{IH}	Input high level	2.1	–	–	V	$V_{dd} = 3.0\text{ to }5.5$.
I_{IL}	Input leakage (absolute value)	–	1	–	nA	Gross tested to 1 μA .
C_{IN}	Capacitive load on pins as input	–	3.5	10	pF	Package and pin dependent. Temp = 25 °C.
C_{OUT}	Capacitive load on pins as output	–	3.5	10	pF	Package and pin dependent. Temp = 25 °C.
R_{PU}	Pull-up resistor	4	5.6	8	k Ω	None
R_{PD}	Pull-down resistor	4	5.6	8	k Ω	None

AC Electrical Characteristics

AC GPIO Specifications

Table 24 lists guaranteed maximum and minimum specifications for the voltage and temperature ranges: 4.75 V to 5.25 V and $-40\text{ }^{\circ}\text{C} \leq T_A \leq 85\text{ }^{\circ}\text{C}$, or 3.0 V to 3.6 V and $-40\text{ }^{\circ}\text{C} \leq T_A \leq 85\text{ }^{\circ}\text{C}$, respectively. Typical parameters apply to 5 V and 3.3 V at 25 °C and are for design guidance only or unless otherwise specified.

Table 24. AC GPIO Specifications

Symbol	Description	Min	Typ	Max	Units	Notes
F_{GPIO}	GPIO Operating Frequency	0	–	12	MHz	Normal Strong Mode
T_{RiseF}	Rise time, normal strong mode, Load = 50 pF	3	–	18	ns	$V_{\text{dd}} = 4.75$ to 5.25 V, 10%–90%
T_{FallF}	Fall time, normal strong mode, Load = 50 pF	2	–	18	ns	$V_{\text{dd}} = 4.75$ to 5.25 V, 10%–90%
T_{RiseS}	Rise time, slow strong mode, Load = 50 pF	10	27	–	ns	$V_{\text{dd}} = 3$ to 5.25 V, 10%–90%
T_{FallS}	Fall time, slow strong mode, Load = 50 pF	10	22	–	ns	$V_{\text{dd}} = 3$ to 5.25 V, 10%–90%
T_{IOAccess}	IO access time	–	–	2.485	ms	None
$T_{\text{Pulsewidth}}$	Minimum pulse width on I/Os to assert INT line.	5.03	–	–	ms	No I ² C activity or EEPROM operation happens during input pulse duration.

Figure 8. GPIO Timing Diagram

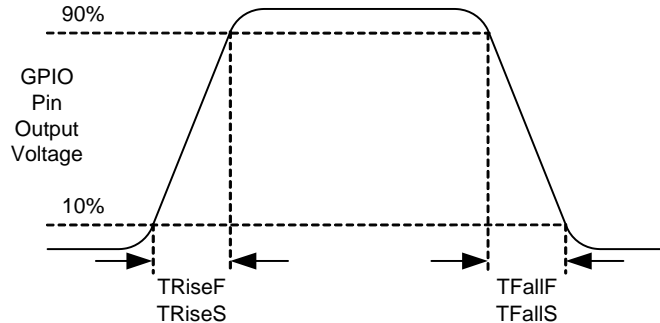

AC PWM Specifications

Table 25 lists guaranteed maximum and minimum specifications for the voltage and temperature ranges: 4.75 V to 5.25 V and $-40\text{ }^{\circ}\text{C} \leq T_A \leq 85\text{ }^{\circ}\text{C}$, or 3.0 V to 3.6 V and $-40\text{ }^{\circ}\text{C} \leq T_A \leq 85\text{ }^{\circ}\text{C}$, respectively. Typical parameters apply to 5 V and 3.3 V at 25 °C and are for design guidance only or unless otherwise specified.

Table 25. AC PWM Specifications

Symbol	Description	Min	Typ	Max	Units	Notes
Jitter24MHzPWM	24 MHz based PWM peak-to-peak period jitter	–	0.1	1.5	%	24 MHz, 1.5 MHz, 93.75 kHz and 367.6 Hz (programmable) sources.
Jitter32kHzPWM	32 kHz-based PWM peak-to-peak period jitter	–	2.5	5.0	%	32 kHz clock source.
F24MHzPWM	Input Frequency of 24 MHz based PWM	23.4	24	24.6	MHz	
F32kHzPWM	Input Frequency of 32 kHz based PWM	15	32	64	kHz	
F1.5MHzPWM	Input frequency of 1.5 MHz based PWM	1.46	1.5	1.53	MHz	

Table 25. AC PWM Specifications

F93.75kHzPWM	Input Frequency of 93.75 kHz based PWM	91.40	93.75	96.09	kHz	
--------------	--	-------	-------	-------	-----	--

AC I²C Specifications

Table 26 lists guaranteed maximum and minimum specifications for the voltage and temperature ranges: 4.75 V to 5.25 V and $-40\text{ }^{\circ}\text{C} \leq T_A \leq 85\text{ }^{\circ}\text{C}$, or 3.0 V to 3.6 V and $-40\text{ }^{\circ}\text{C} \leq T_A \leq 85\text{ }^{\circ}\text{C}$, respectively. Typical parameters apply to 5 V and 3.3 V at 25 °C and are for design guidance only or unless otherwise specified.

Table 26. AC Characteristics of the I²C SDA and SCL Pins

Symbol	Description	Standard Mode		Units	Notes
		Min	Max		
F _{SCL I2C}	SCL clock frequency	0	100	kHz	
T _{HDSTAI2C}	Hold time (repeated) START condition. After this period, the first clock pulse is generated.	4.0	–	μs	
T _{LOWI2C}	LOW period of the SCL clock	4.7	–	μs	
T _{HIGHI2C}	HIGH period of the SCL clock	4.0	–	μs	
T _{SUSTAI2C}	Setup time for a repeated START condition	4.7	–	μs	
T _{HDDATI2C}	Data hold time	0	–	μs	
T _{SUDATI2C}	Data setup time	250	–	ns	
T _{SUSTOI2C}	Setup time for STOP condition	4.0	–	μs	
T _{BUFI2C}	Bus free time between a STOP and START Condition	4.7	–	μs	
T _{SPI2C}	Pulse width of spikes are suppressed by the input filter.	–	–	ns	

Note: Fast mode I²C is not supported.

Figure 9. Definition for Timing for Standard Mode on the I²C Bus

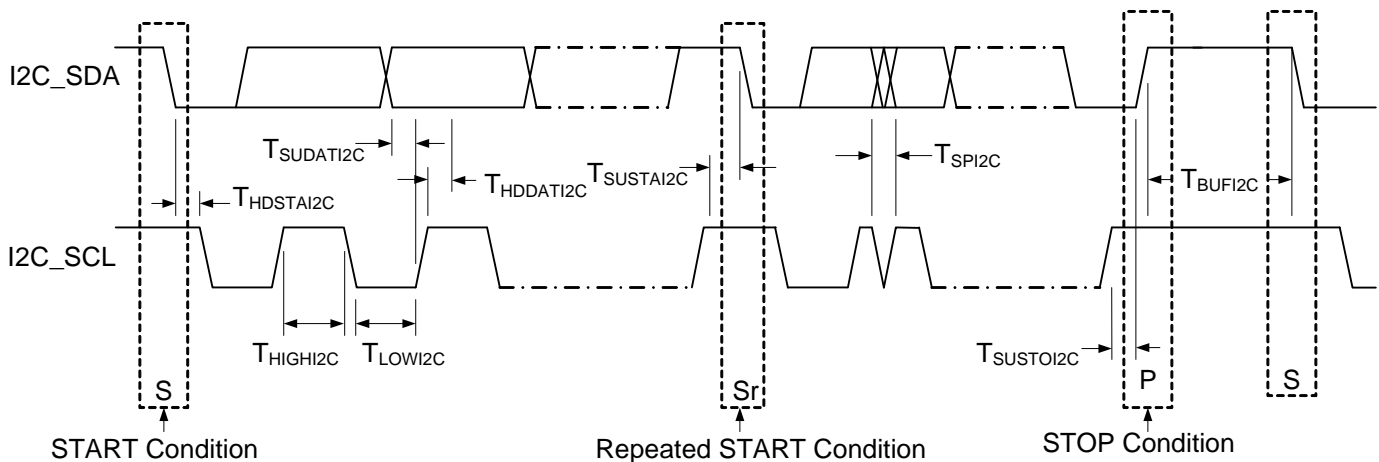

AC EEPROM Write Specifications

Table 27 lists guaranteed maximum and minimum specifications for the voltage and temperature ranges: 4.75 V to 5.25 V and $-40\text{ }^{\circ}\text{C} \leq T_A \leq 85\text{ }^{\circ}\text{C}$, or 3.0 V to 3.6 V and $-40\text{ }^{\circ}\text{C} \leq T_A \leq 85\text{ }^{\circ}\text{C}$, respectively. Typical parameters apply to 5 V and 3.3 V at 25 °C and are for design guidance only or unless otherwise specified.

Table 27. AC EEPROM Write Specifications

Symbol	Description	Min	Typ	Max	Units	Notes
T _{EEPROMWrite_Hot}	EEPROM Erase + Write time	–	–	100	ms	$0\text{ }^{\circ}\text{C} \leq T_j \leq 100\text{ }^{\circ}\text{C}$
T _{EEPROMWrite_Cold}	EEPROM Erase + Write time	–	–	200	ms	$-40\text{ }^{\circ}\text{C} \leq T_j \leq 0\text{ }^{\circ}\text{C}$

Packaging Dimensions

This section illustrates the packaging specifications for the CY8C95xxA device, along with the thermal impedances for each package and the solder reflow peak temperature.

Important Note Emulation tools may require a larger area on the target PCB than the chip's footprint. For a detailed description of the emulation tools' dimensions, refer to the emulator pod drawings at <http://www.cypress.com>.

Figure 10. 28-pin SSOP (210 Mils) Package Outline

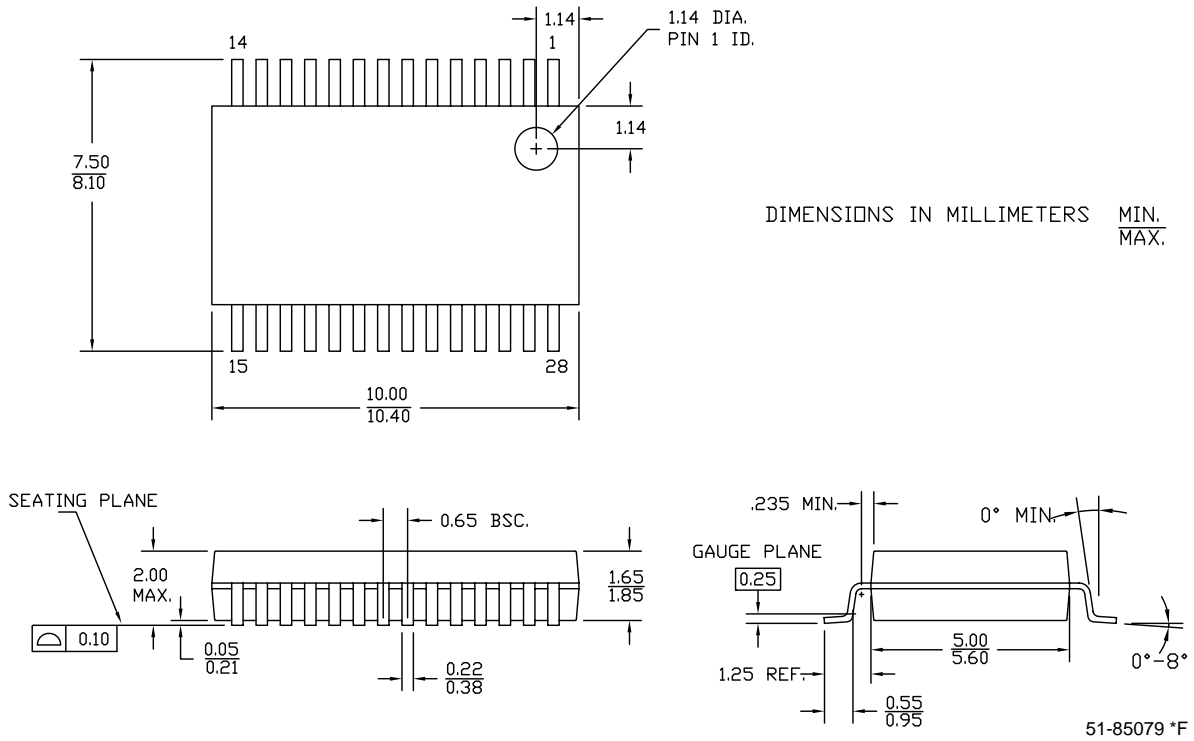

Thermal Impedances

Table 28. Thermal Impedances per Package

Package	Typical θ_{JA} [5]
28-pin SSOP	101 °C/W
48-pin SSOP	69 °C/W
100-pin TQFP	48 °C/W

Solder Reflow Specifications

Table 29 shows the solder reflow temperature limits that must not be exceeded.

Table 29. Solder Reflow Specifications

Package	Maximum Peak Temperature (T_C)	Maximum Time above $T_C - 5$ °C
28-pin SSOP	260 °C	30 seconds
48-pin SSOP	260 °C	30 seconds
100-pin TQFP	260 °C	30 seconds

Notes

5. $T_J = T_A + \text{POWER} \times \theta_{JA}$.

Features and Ordering Information

Table 30 lists the CY8C95xxA device's key package features and ordering codes. A definition of the ordering number code follows.

Table 30. CY8C95xxA Device Key Features and Ordering Information

Package	Ordering Code ^[6]	EEPROM (Bytes)	Temperature Range	PWM Sources	Configurable I/O Pins
28 Pin (210 Mil) SSOP	CY8C9520A-24PVXI	3K	-40 °C to +85°C	4	20
28 Pin (210 Mil) SSOP (Tape and Reel)	CY8C9520A-24PVXIT	3K	-40 °C to +85°C	4	20
48 Pin (300 Mil) SSOP	CY8C9540A-24PVXI	11K	-40 °C to +85°C	8	40
48 Pin (300 Mil) SSOP (Tape and Reel)	CY8C9540A-24PVXIT	11K	-40 °C to +85°C	8	40
100 Pin TQFP	CY8C9560A-24AXI	27K	-40 °C to +85°C	16	60
100 Pin TQFP (Tape and Reel)	CY8C9560A-24AXIT	27K	-40 °C to +85°C	16	60

Ordering Code Definitions

CY 8 C 9 xxx-SPxx

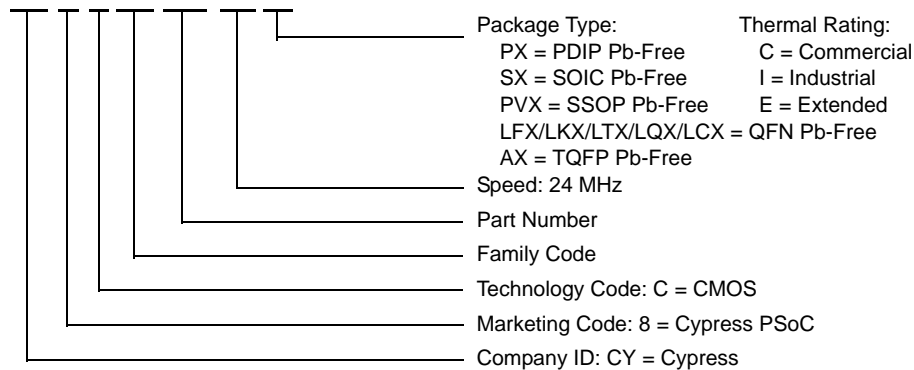

Note

6. The A after the existing port expander part number indicates new device firmware.

Acronyms

Table 31 lists the acronyms that are used in this document.

Table 31. Acronyms Used in this Datasheet

Acronym	Description	Acronym	Description
AC	alternating current	POR	power on reset
API	application programming interface	PSoC [®]	Programmable System-on-Chip
CMOS	complementary metal oxide semiconductor	PWM	pulse width modulator
CRC	cyclic redundancy check	SSOP	shrink small-outline package
DC	direct current	TQFP	thin quad flat pack
EEPROM	electrically erasable programmable read-only memory	UART	universal asynchronous receiver / transmitter
GPIO	general purpose I/O	USB	universal serial bus
I/O	input/output	WDT	watchdog timer
MSB	most-significant bit	XRES	external reset
PCB	printed circuit board		

Document Conventions

Units of Measure

Table 32 lists the units of measures.

Table 32. Units of Measure

Symbol	Unit of Measure	Symbol	Unit of Measure
°C	degree Celsius	mm	millimeter
Hz	hertz	ms	millisecond
kHz	kilohertz	nA	nanoampere
kΩ	kilohm	ns	nanosecond
MHz	megahertz	Ω	ohm
μA	microampere	%	percent
μs	microsecond	pF	picofarad
μV	microvolt	V	volt
μVrms	microvolts root-mean-square	W	watt
mA	milliampere		

Numeric Conventions

Numeric Naming

Hexadecimal numbers are represented with all letters in uppercase with an appended lowercase 'h' (for example, '14h' or '3Ah'). Hexadecimal numbers may also be represented by a '0x' prefix, the C coding convention. Binary numbers have an appended lowercase 'b' (for example, '01010100b' or '01000011b'). Numbers not indicated by an 'h' or 'b' are decimals.

Glossary

active high	<ol style="list-style-type: none"> 1. A logic signal having its asserted state as the logic 1 state. 2. A logic signal having the logic 1 state as the higher voltage of the two states.
analog blocks	The basic programmable opamp circuits. These are SC (switched capacitor) and CT (continuous time) blocks. These blocks can be interconnected to provide ADCs, DACs, multi-pole filters, gain stages, and much more.
analog-to-digital (ADC)	A device that changes an analog signal to a digital signal of corresponding magnitude. Typically, an ADC converts a voltage to a digital number. The digital-to-analog (DAC) converter performs the reverse operation.
Application programming interface (API)	A series of software routines that comprise an interface between a computer application and lower level services and functions (for example, user modules and libraries). APIs serve as building blocks for programmers that create software applications.
asynchronous	A signal whose data is acknowledged or acted upon immediately, irrespective of any clock signal.
bandgap reference	A stable voltage reference design that matches the positive temperature coefficient of V_T with the negative temperature coefficient of V_{BE} , to produce a zero temperature coefficient (ideally) reference.
bandwidth	<ol style="list-style-type: none"> 1. The frequency range of a message or information processing system measured in hertz. 2. The width of the spectral region over which an amplifier (or absorber) has substantial gain (or loss); it is sometimes represented more specifically as, for example, full width at half maximum.
bias	<ol style="list-style-type: none"> 1. A systematic deviation of a value from a reference value. 2. The amount by which the average of a set of values departs from a reference value. 3. The electrical, mechanical, magnetic, or other force (field) applied to a device to establish a reference level to operate the device.
block	<ol style="list-style-type: none"> 1. A functional unit that performs a single function, such as an oscillator. 2. A functional unit that may be configured to perform one of several functions, such as a digital PSoC block or an analog PSoC block.
buffer	<ol style="list-style-type: none"> 1. A storage area for data that is used to compensate for a speed difference, when transferring data from one device to another. Usually refers to an area reserved for IO operations, into which data is read, or from which data is written. 2. A portion of memory set aside to store data, often before it is sent to an external device or as it is received from an external device. 3. An amplifier used to lower the output impedance of a system.
bus	<ol style="list-style-type: none"> 1. A named connection of nets. Bundling nets together in a bus makes it easier to route nets with similar routing patterns. 2. A set of signals performing a common function and carrying similar data. Typically represented using vector notation; for example, address[7:0]. 3. One or more conductors that serve as a common connection for a group of related devices.
clock	The device that generates a periodic signal with a fixed frequency and duty cycle. A clock is sometimes used to synchronize different logic blocks.
comparator	An electronic circuit that produces an output voltage or current whenever two input levels simultaneously satisfy predetermined amplitude requirements.
compiler	A program that translates a high level language, such as C, into machine language.
configuration space	In PSoC devices, the register space accessed when the XIO bit, in the CPU_F register, is set to '1'.
crystal oscillator	An oscillator in which the frequency is controlled by a piezoelectric crystal. Typically a piezoelectric crystal is less sensitive to ambient temperature than other circuit components.
cyclic redundancy check (CRC)	A calculation used to detect errors in data communications, typically performed using a linear feedback shift register. Similar calculations may be used for a variety of other purposes such as data compression.
data bus	A bi-directional set of signals used by a computer to convey information from a memory location to the central processing unit and vice versa. More generally, a set of signals used to convey data between digital functions.

Glossary (continued)

debugger	A hardware and software system that allows you to analyze the operation of the system under development. A debugger usually allows the developer to step through the firmware one step at a time, set break points, and analyze memory.
dead band	A period of time when neither of two or more signals are in their active state or in transition.
digital blocks	The 8-bit logic blocks that can act as a counter, timer, serial receiver, serial transmitter, CRC generator, pseudo-random number generator, or SPI.
digital-to-analog (DAC)	A device that changes a digital signal to an analog signal of corresponding magnitude. The analog-to-digital (ADC) converter performs the reverse operation.
duty cycle	The relationship of a clock period high time to its low time, expressed as a percent.
emulator	Duplicates (provides an emulation of) the functions of one system with a different system, so that the second system appears to behave like the first system.
External Reset (XRES)	An active high signal that is driven into the PSoC device. It causes all operation of the CPU and blocks to stop and return to a pre-defined state.
Flash	An electrically programmable and erasable, non-volatile technology that provides you the programmability and data storage of EPROMs, plus in-system erasability. Non-volatile means that the data is retained when power is OFF.
Flash block	The smallest amount of Flash ROM space that may be programmed at one time and the smallest amount of Flash space that may be protected. A Flash block holds 64 bytes.
frequency	The number of cycles or events per unit of time, for a periodic function.
gain	The ratio of output current, voltage, or power to input current, voltage, or power, respectively. Gain is usually expressed in dB.
I ² C	A two-wire serial computer bus by Philips Semiconductors (now NXP Semiconductors). I2C is an Inter-Integrated Circuit. It is used to connect low-speed peripherals in an embedded system. The original system was created in the early 1980s as a battery control interface, but it was later used as a simple internal bus system for building control electronics. I2C uses only two bi-directional pins, clock and data, both running at +5 V and pulled high with resistors. The bus operates at 100 kbits/second in standard mode and 400 kbits/second in fast mode.
ICE	The in-circuit emulator that allows you to test the project in a hardware environment, while viewing the debugging device activity in a software environment (PSoC Designer).
input/output (I/O)	A device that introduces data into or extracts data from a system.
interrupt	A suspension of a process, such as the execution of a computer program, caused by an event external to that process, and performed in such a way that the process can be resumed.
interrupt service routine (ISR)	A block of code that normal code execution is diverted to when the M8C receives a hardware interrupt. Many interrupt sources may each exist with its own priority and individual ISR code block. Each ISR code block ends with the RETI instruction, returning the device to the point in the program where it left normal program execution.
jitter	<ol style="list-style-type: none"> 1. A misplacement of the timing of a transition from its ideal position. A typical form of corruption that occurs on serial data streams. 2. The abrupt and unwanted variations of one or more signal characteristics, such as the interval between successive pulses, the amplitude of successive cycles, or the frequency or phase of successive cycles.
low-voltage detect (LVD)	A circuit that senses V _{dd} and provides an interrupt to the system when V _{dd} falls below a selected threshold.
M8C	An 8-bit Harvard-architecture microprocessor. The microprocessor coordinates all activity inside a PSoC by interfacing to the Flash, SRAM, and register space.
master device	A device that controls the timing for data exchanges between two devices. Or when devices are cascaded in width, the master device is the one that controls the timing for data exchanges between the cascaded devices and an external interface. The controlled device is called the slave device .

Glossary (continued)

microcontroller	An integrated circuit chip that is designed primarily for control systems and products. In addition to a CPU, a microcontroller typically includes memory, timing circuits, and IO circuitry. The reason for this is to permit the realization of a controller with a minimal quantity of chips, thus achieving maximal possible miniaturization. This in turn, reduces the volume and the cost of the controller. The microcontroller is normally not used for general-purpose computation as is a microprocessor.
mixed-signal	The reference to a circuit containing both analog and digital techniques and components.
modulator	A device that imposes a signal on a carrier.
noise	<ol style="list-style-type: none"> 1. A disturbance that affects a signal and that may distort the information carried by the signal. 2. The random variations of one or more characteristics of any entity such as voltage, current, or data.
oscillator	A circuit that may be crystal controlled and is used to generate a clock frequency.
parity	A technique for testing transmitting data. Typically, a binary digit is added to the data to make the sum of all the digits of the binary data either always even (even parity) or always odd (odd parity).
Phase-locked loop (PLL)	An electronic circuit that controls an oscillator so that it maintains a constant phase angle relative to a reference signal.
pinouts	The pin number assignment: the relation between the logical inputs and outputs of the PSoC device and their physical counterparts in the printed circuit board (PCB) package. Pinouts involve pin numbers as a link between schematic and PCB design (both being computer generated files) and may also involve pin names.
port	A group of pins, usually eight.
Power on reset (POR)	A circuit that forces the PSoC device to reset when the voltage is below a pre-set level. This is one type of hardware reset.
PSoC [®]	Cypress Semiconductor's PSoC [®] is a registered trademark and Programmable System-on-Chip [™] is a trademark of Cypress.
PSoC Designer [™]	The software for Cypress' Programmable System-on-Chip technology.
pulse width modulator (PWM)	An output in the form of duty cycle which varies as a function of the applied measurand
RAM	An acronym for random access memory. A data-storage device from which data can be read out and new data can be written in.
register	A storage device with a specific capacity, such as a bit or byte.
reset	A means of bringing a system back to a know state. See hardware reset and software reset.
ROM	An acronym for read only memory. A data-storage device from which data can be read out, but new data cannot be written in.
serial	<ol style="list-style-type: none"> 1. Pertaining to a process in which all events occur one after the other. 2. Pertaining to the sequential or consecutive occurrence of two or more related activities in a single device or channel.
settling time	The time it takes for an output signal or value to stabilize after the input has changed from one value to another.
shift register	A memory storage device that sequentially shifts a word either left or right to output a stream of serial data.
slave device	A device that allows another device to control the timing for data exchanges between two devices. Or when devices are cascaded in width, the slave device is the one that allows another device to control the timing of data exchanges between the cascaded devices and an external interface. The controlling device is called the master device.
SRAM	An acronym for static random access memory. A memory device where you can store and retrieve data at a high rate of speed. The term static is used because, after a value is loaded into an SRAM cell, it remains unchanged until it is explicitly altered or until power is removed from the device.
SROM	An acronym for supervisory read only memory. The SROM holds code that is used to boot the device, calibrate circuitry, and perform Flash operations. The functions of the SROM may be accessed in normal user code, operating from Flash.

Glossary (continued)

stop bit	A signal following a character or block that prepares the receiving device to receive the next character or block.
synchronous	1. A signal whose data is not acknowledged or acted upon until the next active edge of a clock signal. 2. A system whose operation is synchronized by a clock signal.
tri-state	A function whose output can adopt three states: 0, 1, and Z (high-impedance). The function does not drive any value in the Z state and, in many respects, may be considered to be disconnected from the rest of the circuit, allowing another output to drive the same net.
UART	A UART or universal asynchronous receiver-transmitter translates between parallel bits of data and serial bits.
user modules	Pre-build, pre-tested hardware/firmware peripheral functions that take care of managing and configuring the lower level Analog and Digital PSoC Blocks. User Modules also provide high level API (Application Programming Interface) for the peripheral function.
user space	The bank 0 space of the register map. The registers in this bank are more likely to be modified during normal program execution and not just during initialization. Registers in bank 1 are most likely to be modified only during the initialization phase of the program.
V_{DD}	A name for a power net meaning “voltage drain.” The most positive power supply signal. Usually 5 V or 3.3 V.
V_{SS}	A name for a power net meaning “voltage source.” The most negative power supply signal.
watchdog timer	A timer that must be serviced periodically. If it is not serviced, the CPU resets after a specified period of time.

Errata

This section describes the errata for CY8C9560A device. Details include the trigger condition, scope of impact, available workaround, and silicon revision applicability. Contact your local Cypress Sales Representative if you have questions.

Part Numbers Affected

Part Number
CY8C9560A

Qualification Status

CY8C9560A Rev. A – In Production

Errata Summary

The following table defines the errata applicability to available devices.

Items	Part Number	Silicon Revision	Fix Status
1. The command 01h cannot store more than 128 bytes of configuration data from SRAM to EEPROM.	CY8C9560A	A	No silicon fix planned. Workaround is required.

1. The command 01h cannot store more than 128 bytes of configuration data from SRAM to EEPROM.

□ Problem Definition

The Store Config to E² POR Defaults Cmd (01h) can write only up to 128 bytes of configuration data from SRAM to the EEPROM. Configuration data exceeding 128 bytes are ignored.

□ Parameters Affected

NA

□ Trigger Condition

NA

□ Scope of Impact

Configuration data from SRAM to EEPROM exceeding 128 bytes are ignored.

□ Workaround

As a workaround, use the Write E² POR Defaults Cmd (03h) command to explicitly write all configuration data to EEPROM using I²C.

□ Fix Status

No fixes are planned. You must use the recommended workaround.

Document History Page

Document Title: CY8C9520A/CY8C9540A/CY8C9560A, 20-, 40-, and 60-Bit I/O Expander with EEPROM				
Document Number: 38-12036				
Revision	ECN	Orig. of Change	Submission Date	Description of Change
**	346754	HMT	See ECN	New silicon, document.
*A	392484	HMT	See ECN	Correct pin 79 on the TQFP. Add AC PWM Output Jitter spec. table. Upgrade to CY Perform logo and update zip code and trademarks.
*B	1336984	HMT / AESA	See ECN	Update typical and recommended Storage Temperature per industrial specs. Update copyright and trademarks. Add Watchdog timer details. Add "A" to existing part numbers to indicate new firmware. Fix errors. Implement CY template.
*C	2843174	YARA	01/08/2010	Added Contents . Updated Overview . Updated Pin 11 description in Figure 2 on page 5 . Modified Note 3. Added I _{OH} and I _{OL} specifications in DC GPIO Specifications . Removed "Output Jitter" from AC PWM Specifications section on page 18. Added F24MHzPWM, F32kHzPWM, and F93.5kHzPWM specifications in Table 25 . Added Table 27 .
*D	2903402	NJF	04/01/2010	Updated Cypress website links Added T _{BAKETEMP} and T _{BAKETIME} parameters Updated package diagrams
*E	3110285	NJF	12/14/10	Added text "When the part is held in reset all In and Out pins are held at their default High-Z State" to section "External Reset Pin (XRES)" on page 9. Added DC I ² C Specifications table. Updated Units of Measure, Acronyms, Glossary, and References sections. Updated solder reflow specifications. No specific changes made to I ² C Timing Diagram. It has been updated for clearer understanding.
*F	3381717	NPD	09/23/11	Updated solder reflow specifications to improve clarity. Updated package diagrams.
*G	4512488	DIMA	09/24/2014	Updated Pin Descriptions : Updated Extendable Soft Addressing : Updated description. Updated Interrupt Pin (INT) : Updated description. Updated Electrical Specifications : Updated DC Electrical Characteristics : Updated DC GPIO Specifications : Updated Table 23 : Added R _{PU} , R _{PD} parameters and their details. Updated AC Electrical Characteristics : Updated AC GPIO Specifications : Updated Table 24 : Added TIOAccess parameter and its details. Updated AC I2C Specifications : Updated Table 26 (Removed the column "Fast Mode"). Updated Figure 9 (No change in figure, removed "Fast" in caption only). Updated Packaging Dimensions : spec 51-85061 – Changed revision from *E to *F. spec 51-85048 – Changed revision from *E to *I. Updated to new template. Completing Sunset Review.
*H	4569861	ASRI	11/22/2014	Added Errata .
*I	4708108	DIMA	04/01/2015	Added minimum input pulse width in Table 24 . Removed reference to obsolete application note, AN2304.

Sales, Solutions, and Legal Information

Worldwide Sales and Design Support

Cypress maintains a worldwide network of offices, solution centers, manufacturer's representatives, and distributors. To find the office closest to you, visit us at [Cypress Locations](#).

Products

Automotive	cypress.com/go/automotive
Clocks & Buffers	cypress.com/go/clocks
Interface	cypress.com/go/interface
Lighting & Power Control	cypress.com/go/powerpsoc
Memory	cypress.com/go/memory
PSoC	cypress.com/go/psoc
Touch Sensing	cypress.com/go/touch
USB Controllers	cypress.com/go/USB
Wireless/RF	cypress.com/go/wireless

PSoC[®] Solutions

psoc.cypress.com/solutions
PSoC 1 | PSoC 3 | PSoC 4 | PSoC 5LP

Cypress Developer Community

[Community](#) | [Forums](#) | [Blogs](#) | [Video](#) | [Training](#)

Technical Support

cypress.com/go/support

© Cypress Semiconductor Corporation, 2005-2015. The information contained herein is subject to change without notice. Cypress Semiconductor Corporation assumes no responsibility for the use of any circuitry other than circuitry embodied in a Cypress product. Nor does it convey or imply any license under patent or other rights. Cypress products are not warranted nor intended to be used for medical, life support, life saving, critical control or safety applications, unless pursuant to an express written agreement with Cypress. Furthermore, Cypress does not authorize its products for use as critical components in life-support systems where a malfunction or failure may reasonably be expected to result in significant injury to the user. The inclusion of Cypress products in life-support systems application implies that the manufacturer assumes all risk of such use and in doing so indemnifies Cypress against all charges.

Any Source Code (software and/or firmware) is owned by Cypress Semiconductor Corporation (Cypress) and is protected by and subject to worldwide patent protection (United States and foreign), United States copyright laws and international treaty provisions. Cypress hereby grants to licensee a personal, non-exclusive, non-transferable license to copy, use, modify, create derivative works of, and compile the Cypress Source Code and derivative works for the sole purpose of creating custom software and/or firmware in support of licensee product to be used only in conjunction with a Cypress integrated circuit as specified in the applicable agreement. Any reproduction, modification, translation, compilation, or representation of this Source Code except as specified above is prohibited without the express written permission of Cypress.

Disclaimer: CYPRESS MAKES NO WARRANTY OF ANY KIND, EXPRESS OR IMPLIED, WITH REGARD TO THIS MATERIAL, INCLUDING, BUT NOT LIMITED TO, THE IMPLIED WARRANTIES OF MERCHANTABILITY AND FITNESS FOR A PARTICULAR PURPOSE. Cypress reserves the right to make changes without further notice to the materials described herein. Cypress does not assume any liability arising out of the application or use of any product or circuit described herein. Cypress does not authorize its products for use as critical components in life-support systems where a malfunction or failure may reasonably be expected to result in significant injury to the user. The inclusion of Cypress' product in a life-support systems application implies that the manufacturer assumes all risk of such use and in doing so indemnifies Cypress against all charges.

Use may be limited by and subject to the applicable Cypress software license agreement.



Компания «ЭлектроПласт» предлагает заключение долгосрочных отношений при поставках импортных электронных компонентов на взаимовыгодных условиях!

Наши преимущества:

- Оперативные поставки широкого спектра электронных компонентов отечественного и импортного производства напрямую от производителей и с крупнейших мировых складов;
- Поставка более 17-ти миллионов наименований электронных компонентов;
- Поставка сложных, дефицитных, либо снятых с производства позиций;
- Оперативные сроки поставки под заказ (от 5 рабочих дней);
- Экспресс доставка в любую точку России;
- Техническая поддержка проекта, помощь в подборе аналогов, поставка прототипов;
- Система менеджмента качества сертифицирована по Международному стандарту ISO 9001;
- Лицензия ФСБ на осуществление работ с использованием сведений, составляющих государственную тайну;
- Поставка специализированных компонентов (Xilinx, Altera, Analog Devices, Intersil, Interpoint, Microsemi, Aeroflex, Peregrine, Syfer, Eurofarad, Texas Instrument, Miteq, Cobham, E2V, MA-COM, Hittite, Mini-Circuits, General Dynamics и др.);

Помимо этого, одним из направлений компании «ЭлектроПласт» является направление «Источники питания». Мы предлагаем Вам помощь Конструкторского отдела:

- Подбор оптимального решения, техническое обоснование при выборе компонента;
- Подбор аналогов;
- Консультации по применению компонента;
- Поставка образцов и прототипов;
- Техническая поддержка проекта;
- Защита от снятия компонента с производства.



Как с нами связаться

Телефон: 8 (812) 309 58 32 (многоканальный)

Факс: 8 (812) 320-02-42

Электронная почта: org@eplast1.ru

Адрес: 198099, г. Санкт-Петербург, ул. Калинина, дом 2, корпус 4, литера А.