

# General Specifications

## Electrical Capacity (Resistive Load)

|  |   |
|--|---|
| <b>Power Level (silver):</b>                     | 6A @ 125V AC or 3A @ 250V AC;<br>4A @ 30V DC (On-On circuit) & 3A @ 30V DC (all other circuits) |
| <b>Logic Level (gold):</b>                       | 0.4VA maximum @ 28V AC/DC maximum<br>(Applicable Range 0.1mA ~ 0.1A @ 20mV ~ 28V)               |
| <b>Logic/Power Level:<br/>(gold over silver)</b> | Combines silver & gold ratings  |

Note: Find additional explanation of dual rating & operating range in Supplement section.

## Other Ratings

|                               |  |
|-------------------------------|--|
| <b>Contact Resistance:</b>    | 10 milliohms maximum for silver; 20 milliohms maximum for gold   |
| <b>Insulation Resistance:</b> | 1,000 megohms minimum @ 500V DC  |
| <b>Dielectric Strength:</b>   | 1,000V AC minimum between contacts for 1 minute minimum;<br>1,500V AC minimum between contacts & case for 1 minute minimum |
| <b>Mechanical Life:</b>       | 100,000 operations minimum   |
| <b>Electrical Life:</b>       | 25,000 operations minimum for silver; 50,000 operations minimum for gold   |
| <b>Contact Timing:</b>        | Nonshorting (break-before-make)  |
| <b>Angle of Throw:</b>        | 26°  |

## Materials & Finishes

|                             |  |
|-----------------------------|--|
| <b>Toggle/Lever:</b>        | Brass with nickel plating  |
| <b>Support Bracket:</b>     | Brass with tin plating   |
| <b>Bushing/Housing:</b>     | Glass fiber reinforced polyamide (UL94V-0)   |
| <b>Sealing Ring:</b>        | Nitrile butadiene rubber   |
| <b>Base:</b>                | Glass fiber reinforced polyamide (UL94V-0)   |
| <b>Movable Contacts:</b>    | Silver alloy with silver plating (code W); copper or phosphor bronze with gold plating (code G);<br>or silver alloy with gold plating (code A) |
| <b>Stationary Contacts:</b> | Silver alloy with silver plating (code W); copper or brass with gold plating (code G);<br>or silver alloy with gold plating (code A)           |
| <b>Terminals:</b>           | Copper or brass with silver or gold plating  |

## Environmental Data

|                              |   |
|------------------------------|---|
| <b>Operating Temp Range:</b> | -30°C through +85°C (-22°F through +185°F)  |
| <b>Humidity:</b>             | 90 ~ 95% humidity for 96 hours @ 40°C (104°F)   |
| <b>Vibration:</b>            | 10 ~ 55Hz with peak-to-peak amplitude of 1.5mm traversing the frequency range & returning in<br>1 minute; 3 right angled directions for 2 hours |
| <b>Shock:</b>                | 50G (490m/s <sup>2</sup> ) acceleration (tested in 6 right angled directions, with 5 shocks in each direction)                                  |

## PCB Processing

|                   |  |
|-------------------|--|
| <b>Soldering:</b> | Wave Soldering Recommended: See Profile B in Supplement section.<br>Manual Soldering: See Profile B in Supplement section. |
| <b>Cleaning:</b>  | Automated cleaning. See Cleaning specifications in Supplement section.   |

## Standards & Certifications

|                                |   |
|--------------------------------|---|
| <b>Flammability Standards:</b> | UL94V-0 rated bushing/housing & base  |
| <b>UL:</b>                     | <b>File No. E44145 - Recognized only when ordered with marking on switch.</b><br>Add "/U" or "/CUL" before first dash in part number to order UL recognized switch.<br>All models recognized at 6A @ 125V AC, 3A @ 250V AC, & 4A @ 30V DC or 0.4A @ 28V DC. |
| <b>CSA:</b>                    | <b>File No. 023535_0_000 - Certified only when ordered with marking on switch.</b><br>Add "/C" to end of part number to order CSA certified switch.<br>All models certified at 6A @ 125V AC, 3A @ 250V AC, & 4A @ 30V DC.                                   |

# Distinctive Characteristics

Antijamming actuator design protects against mechanism damage from downward force on the toggle.

Single unit construction of the bushing and top of the housing gives protection from cleaning fluids or other liquids.

O-ring surrounding actuator at top of bushing interior prevents liquids from reaching switch mechanism.

Ultrasonic welding of upper and lower housing seals out contaminants and allows automated soldering and cleaning.

Terminals are epoxy sealed to prevent entry of flux, solvents, and other contaminants.

Bracketed models have crimped legs to ensure secure PC mounting and prevent dislodging during automated soldering.

Logic level and power capabilities are available to suit varying applications.



Actual Size



### TYPICAL SWITCH ORDERING EXAMPLE

**M2T**

**1**

**2**

**S**

**A5**

**G**

**03**

| Poles |      |
|-------|------|
| 1     | SPDT |
| 2     | DPDT |

| Bushing |                                  |
|---------|----------------------------------|
| A5      | .250" (6.35mm)<br>Double Flatted |

| PC Terminals |   |
|--------------|---|
| 03           | Straight                                |
| 13           | Straight with<br>.460" (11.7mm) Bracket |
| 30           | .150" (3.81mm) Right Angle              |
| 40           | .150" (3.81mm) Vertical                 |
| 05           | .390" (9.9mm) Extended PC               |
| 06           | .728" (18.5mm) Extended PC              |
| 07           | .945" (24.0mm) Extended PC              |

| Circuits |      |      |      |
|----------|------|------|------|
| 2        | ON   | NONE | ON   |
| 3        | ON   | OFF  | ON   |
| 5        | ON   | NONE | (ON) |
| 8        | (ON) | OFF  | (ON) |
| 9        | ON   | OFF  | (ON) |

( ) = Momentary

| Contact Materials & Ratings |  |
|-----------------------------|--|
| W                           | Silver; Rated<br>6A @ 125V AC & 3A @ 250V AC                           |
| G                           | Gold; Rated<br>0.4VA max @ 28V AC/DC max                               |
| A                           | Gold over Silver; Rated<br>6A @ 125V AC &<br>0.4VA max @ 28V AC/DC max |

| Actuators |                             |
|-----------|-----------------------------|
| S         | .500" (12.7mm)<br>Bat Lever |
| S4        | .300" (7.62mm)<br>Bat Lever |

#### IMPORTANT:



Switches are supplied without UL, cULus & CSA marking unless specified. **UL, cULus & CSA recognized only when ordered with marking on the switch.** Specific models, ratings, & ordering instructions are noted on General Specifications page.

#### DESCRIPTION FOR TYPICAL ORDERING EXAMPLE

**M2T12SA5G03**

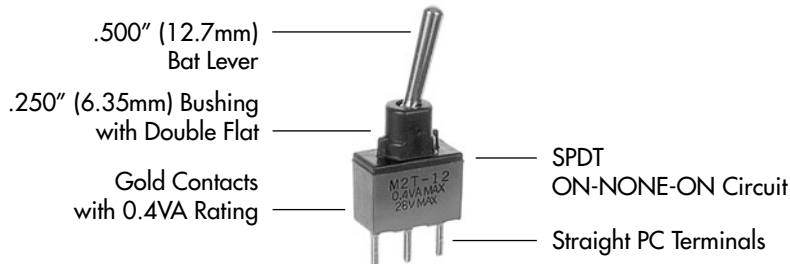

## POLES & CIRCUITS

| Pole | Model                                     | Toggle Position<br>( ) = Momentary |                                   |                                  | Connected Terminals |        |         | Throw & Schematics                                     |
|------|---|------------------------------------|-----------------------------------|----------------------------------|---------------------|--------|---------|--|
|      |   | Down                               | Center                            | Up                               | Down                | Center | Up      |  |
|      |   |                                    |                                   |                                  |                     |        |         | Note: Terminal numbers are not actually on the switch. |
| SP   | M2T12<br>M2T13<br>M2T15<br>M2T18<br>M2T19 | ON<br>ON<br>ON<br>(ON)<br>ON       | NONE<br>OFF<br>NONE<br>OFF<br>OFF | ON<br>ON<br>(ON)<br>(ON)<br>(ON) | 2-3                 | OPEN   | 2-1     | SPDT<br>   |
| DP   | M2T22<br>M2T23<br>M2T25<br>M2T28<br>M2T29 | ON<br>ON<br>ON<br>(ON)<br>ON       | NONE<br>OFF<br>NONE<br>OFF<br>OFF | ON<br>ON<br>(ON)<br>(ON)<br>(ON) | 2-3 5-6             | OPEN   | 2-1 5-4 | DPDT<br>   |

## ACTUATORS

**S** .500" (12.7mm)  
Bat Lever

Material:  
Nickel over Brass



**S4** .300" (7.62mm)  
Bat Lever

Material:  
Nickel over Brass

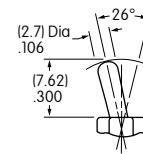

**Standard Combinations:** S Bat Lever with straight terminals (code 03) with silver or gold contacts.

**Standard Combinations:** S4 Bat Lever with bracketed terminals (codes 13, 30, 40) with silver or gold contacts.

## BUSHING

**A5** .250" (6.35mm) Double Flatted

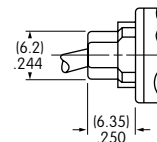

## CONTACT MATERIALS & RATINGS

**W** Silver over Silver **Power Level** 6A @ 125V AC & 3A @ 250V AC

**G** Gold over Brass or Copper **Logic Level** 0.4VA maximum @ 28V AC/DC maximum  
Complete explanation of operating range in Supplement section.

**A** Gold over Silver **Power Level or Logic Level** 6A @ 125V AC or 0.4VA maximum @ 28V AC/DC maximum

Note: This dual rated option is suitable when two or more identical switches are used in logic and in power circuits within the same application. See Supplement section for complete explanation of dual rating and operating range.

## PC TERMINALS

### 03 Straight

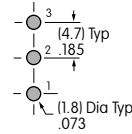

Single Pole

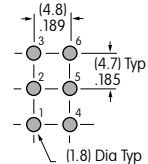

Double Pole

### 13 Straight with .460" (11.7mm) Bracket

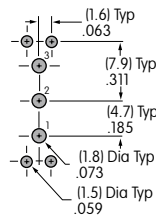
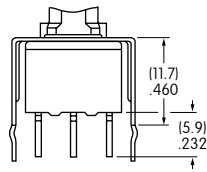

Single Pole

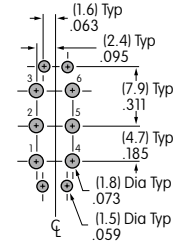

Double Pole

### 30 .150" (3.81mm) Right Angle

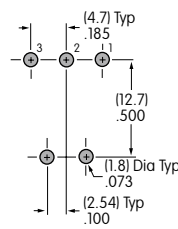
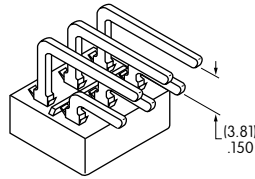

Single Pole

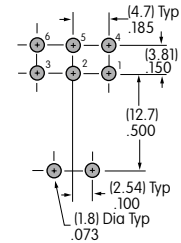

Double Pole

### 40 .150" (3.81mm) Vertical

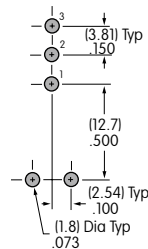
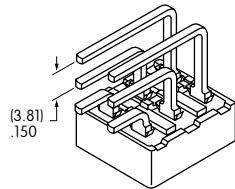

Single Pole



Double Pole

### 05 .390" (9.9mm) Extended PC

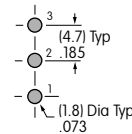
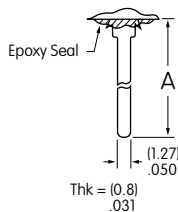

Single Pole

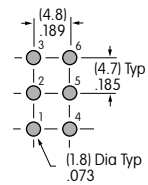

Double Pole

### 06 .728" (18.5mm) Extended PC

### 07 .945" (24.0mm) Extended PC

Dimension A = terminal lengths as shown beside the terminal codes at the left.

## TYPICAL SWITCH DIMENSIONS

### Single Pole

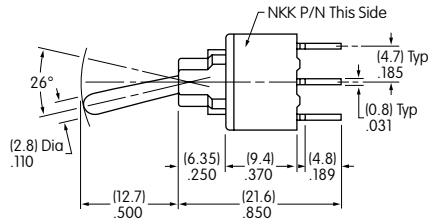
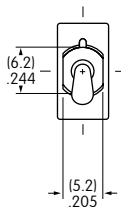

Actuator in Down Position

### Straight PC

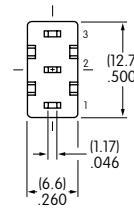

M2T12SA5G03

### Double Pole

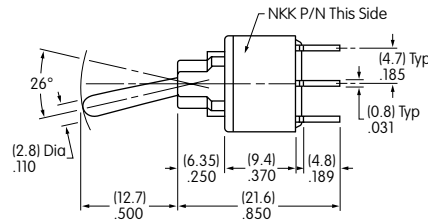
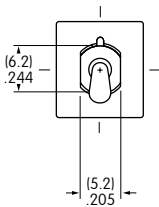

Actuator in Down Position

### Straight PC

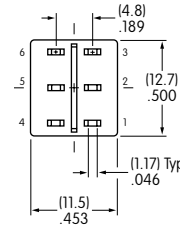

M2T22SA5G03

### Single & Double Pole

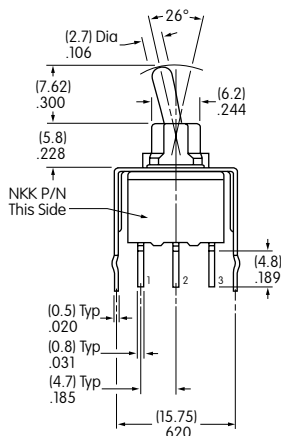

Actuator in Down Position

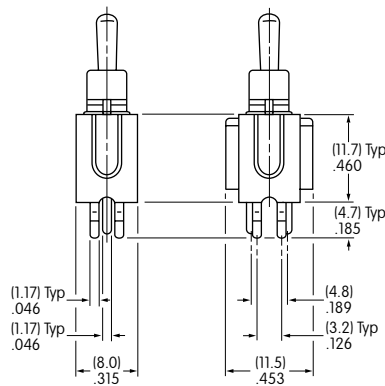

### Straight PC • Bracket



M2T12SA45G13

## TYPICAL SWITCH DIMENSIONS

### Right Angle PC



### Single Pole

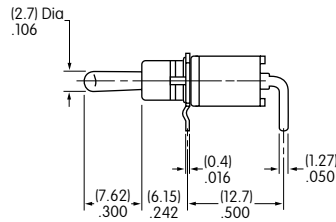

**M2T12S4A5G30**

Actuator in Down Position

### Right Angle PC



### Double Pole

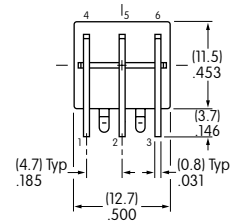

**M2T22S4A5G30**

Actuator in Down Position

### Vertical PC

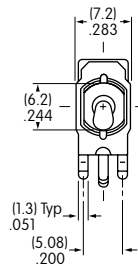

### Single Pole

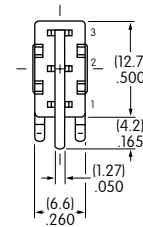
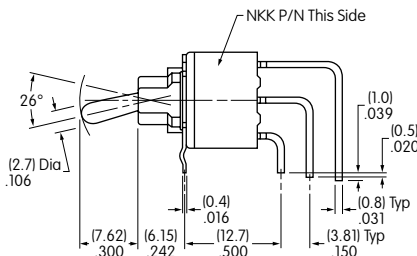

**M2T12S4A5G40**

Actuator in Down Position

### Vertical PC

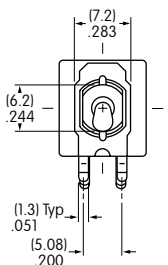

### Double Pole

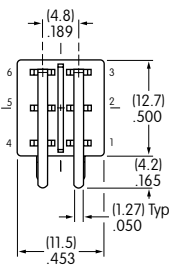
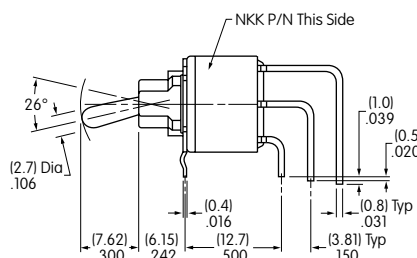

**M2T22S4A5G40**

Actuator in Down Position

## HANDLING PRECAUTION

When an application employs M2T model with silver contacts, 5 to 6A @ 125V AC, and the switch will be actuated 100 or more times per day, note these instructions:

Peel off the film seal on the switch body situated over the part number after cleaning.



Компания «ЭлектроПласт» предлагает заключение долгосрочных отношений при поставках импортных электронных компонентов на взаимовыгодных условиях!

Наши преимущества:

- Оперативные поставки широкого спектра электронных компонентов отечественного и импортного производства напрямую от производителей и с крупнейших мировых складов;
- Поставка более 17-ти миллионов наименований электронных компонентов;
- Поставка сложных, дефицитных, либо снятых с производства позиций;
- Оперативные сроки поставки под заказ (от 5 рабочих дней);
- Экспресс доставка в любую точку России;
- Техническая поддержка проекта, помощь в подборе аналогов, поставка прототипов;
- Система менеджмента качества сертифицирована по Международному стандарту ISO 9001;
- Лицензия ФСБ на осуществление работ с использованием сведений, составляющих государственную тайну;
- Поставка специализированных компонентов (Xilinx, Altera, Analog Devices, Intersil, Interpoint, Microsemi, Aeroflex, Peregrine, Syfer, Eurofarad, Texas Instrument, Miteq, Cobham, E2V, MA-COM, Hittite, Mini-Circuits, General Dynamics и др.);

Помимо этого, одним из направлений компании «ЭлектроПласт» является направление «Источники питания». Мы предлагаем Вам помощь Конструкторского отдела:

- Подбор оптимального решения, техническое обоснование при выборе компонента;
- Подбор аналогов;
- Консультации по применению компонента;
- Поставка образцов и прототипов;
- Техническая поддержка проекта;
- Защита от снятия компонента с производства.



#### Как с нами связаться

**Телефон:** 8 (812) 309 58 32 (многоканальный)

**Факс:** 8 (812) 320-02-42

**Электронная почта:** [org@eplast1.ru](mailto:org@eplast1.ru)

**Адрес:** 198099, г. Санкт-Петербург, ул. Калинина, дом 2, корпус 4, литера А.