

General Specifications

Electrical Capacity (Resistive Load)

- Power Level (silver):** 6A @ 125V AC or 3A @ 250V AC;
4A @ 30V DC (On-On circuit) & 3A @ 30V DC (all other circuits)
- Logic Level (gold):** 0.4VA maximum @ 28V AC/DC maximum
(Applicable Range 0.1mA ~ 0.1A @ 20mV ~ 28V)
- Logic/Power Level:
(gold over silver)** Combines silver & gold ratings

Note: Find additional explanation of dual rating & operating range in Supplement section.

Other Ratings

- Contact Resistance:** 10 milliohms maximum for silver; 20 milliohms maximum for gold
- Insulation Resistance:** 1,000 megohms minimum @ 500V DC
- Dielectric Strength:** 1,000V AC minimum between contacts for 1 minute minimum;
1,500V AC minimum between contacts & case for 1 minute minimum
- Mechanical Life:** 100,000 operations minimum
- Electrical Life:** 25,000 operations minimum for silver; 50,000 operations minimum for gold
- Contact Timing:** Nonshorting (break-before-make)
- Angle of Throw:** 26°

Materials & Finishes

- Toggle/Lever:** Brass with nickel plating
- Support Bracket:** Brass with tin plating
- Bushing/Housing:** Glass fiber reinforced polyamide (UL94V-0)
- Sealing Ring:** Nitrile butadiene rubber
- Base:** Glass fiber reinforced polyamide (UL94V-0)
- Movable Contacts:** Silver alloy with silver plating (code W); copper or phosphor bronze with gold plating (code G);
or silver alloy with gold plating (code A)
- Stationary Contacts:** Silver alloy with silver plating (code W); copper or brass with gold plating (code G);
or silver alloy with gold plating (code A)
- Terminals:** Copper or brass with silver or gold plating

Environmental Data

- Operating Temp Range:** -30°C through +85°C (-22°F through +185°F)
- Humidity:** 90 ~ 95% humidity for 96 hours @ 40°C (104°F)
- Vibration:** 10 ~ 55Hz with peak-to-peak amplitude of 1.5mm traversing the frequency range & returning in
1 minute; 3 right angled directions for 2 hours
- Shock:** 50G (490m/s²) acceleration (tested in 6 right angled directions, with 5 shocks in each direction)

PCB Processing

- Soldering:** Wave Soldering Recommended: See Profile B in Supplement section.
Manual Soldering: See Profile B in Supplement section.
- Cleaning:** Automated cleaning. See Cleaning specifications in Supplement section.

Standards & Certifications

- Flammability Standards:** UL94V-0 rated bushing/housing & base
- UL:** **File No. E44145 - Recognized only when ordered with marking on switch.**
Add "/U" or "/CUL" before first dash in part number to order UL recognized switch.
All models recognized at 6A @ 125V AC, 3A @ 250V AC, & 4A @ 30V DC or 0.4A @ 28V DC.
- CSA:** **File No. 023535_0_000 - Certified only when ordered with marking on switch.**
Add "/C" to end of part number to order CSA certified switch.
All models certified at 6A @ 125V AC, 3A @ 250V AC, & 4A @ 30V DC.

Distinctive Characteristics

Antijamming actuator design protects against mechanism damage from downward force on the toggle.

Single unit construction of the bushing and top of the housing gives protection from cleaning fluids or other liquids.

O-ring surrounding actuator at top of bushing interior prevents liquids from reaching switch mechanism.

Ultrasonic welding of upper and lower housing seals out contaminants and allows automated soldering and cleaning.

Terminals are epoxy sealed to prevent entry of flux, solvents, and other contaminants.

Bracketed models have crimped legs to ensure secure PC mounting and prevent dislodging during automated soldering.

Logic level and power capabilities are available to suit varying applications.

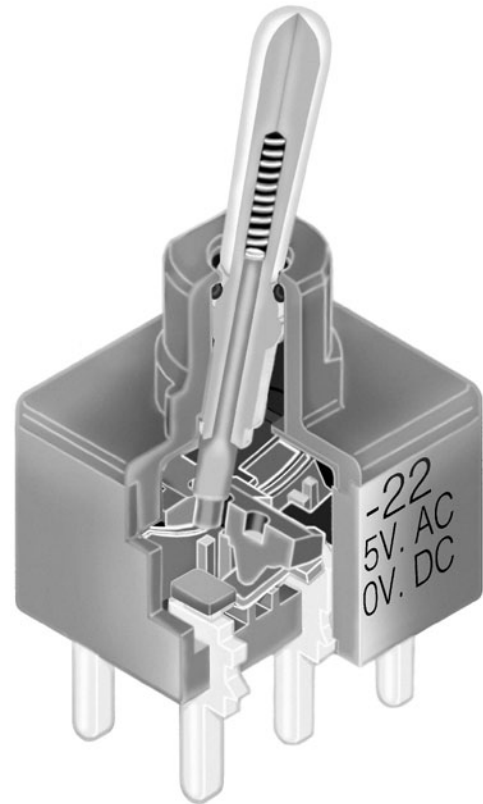

Actual Size

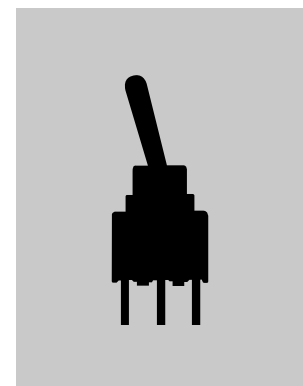

TYPICAL SWITCH ORDERING EXAMPLE

M2T

1

2

S

A5

G

03

Poles	
1	SPDT
2	DPDT

Bushing	
A5	.250" (6.35mm) Double Flatted

PC Terminals	
03	Straight
13	Straight with .460" (11.7mm) Bracket
30	.150" (3.81mm) Right Angle
40	.150" (3.81mm) Vertical
05	.390" (9.9mm) Extended PC
06	.728" (18.5mm) Extended PC
07	.945" (24.0mm) Extended PC

Circuits			
2	ON	NONE	ON
3	ON	OFF	ON
5	ON	NONE	(ON)
8	(ON)	OFF	(ON)
9	ON	OFF	(ON)

() = Momentary

Contact Materials & Ratings	
W	Silver; Rated 6A @ 125V AC & 3A @ 250V AC
G	Gold; Rated 0.4VA max @ 28V AC/DC max
A	Gold over Silver; Rated 6A @ 125V AC & 0.4VA max @ 28V AC/DC max

Actuators	
S	.500" (12.7mm) Bat Lever
S4	.300" (7.62mm) Bat Lever

IMPORTANT:



Switches are supplied without UL, cULus & CSA marking unless specified. **UL, cULus & CSA recognized only when ordered with marking on the switch.** Specific models, ratings, & ordering instructions are noted on General Specifications page.

DESCRIPTION FOR TYPICAL ORDERING EXAMPLE

M2T12SA5G03

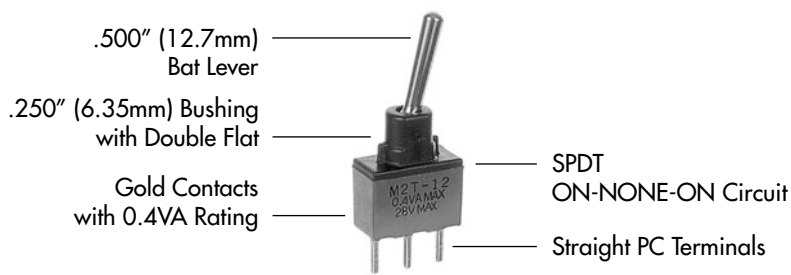

POLES & CIRCUITS

Pole	Model	Toggle Position () = Momentary			Connected Terminals			Throw & Schematics
		Down	Center	Up	Down	Center	Up	
								Note: Terminal numbers are not actually on the switch.
SP	M2T12 M2T13 M2T15 M2T18 M2T19	ON ON ON (ON) ON	NONE OFF NONE OFF OFF	ON ON (ON) (ON) (ON)	2-3	OPEN	2-1	SPDT
DP	M2T22 M2T23 M2T25 M2T28 M2T29	ON ON ON (ON) ON	NONE OFF NONE OFF OFF	ON ON (ON) (ON) (ON)	2-3 5-6	OPEN	2-1 5-4	DPDT

ACTUATORS

S .500" (12.7mm)
Bat Lever

Material:
Nickel over Brass

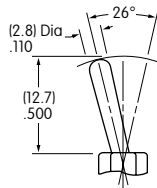

S4 .300" (7.62mm)
Bat Lever

Material:
Nickel over Brass

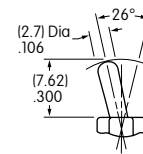

Standard Combinations: S Bat Lever with straight terminals (code 03) with silver or gold contacts.

Standard Combinations: S4 Bat Lever with bracketed terminals (codes 13, 30, 40) with silver or gold contacts.

BUSHING

A5 .250" (6.35mm) Double Flatted

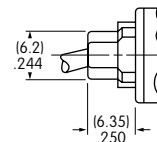
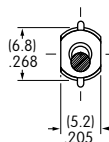

CONTACT MATERIALS & RATINGS

W Silver over Silver Power Level 6A @ 125V AC & 3A @ 250V AC

G Gold over Brass or Copper Logic Level 0.4VA maximum @ 28V AC/DC maximum
Complete explanation of operating range in Supplement section.

A Gold over Silver Power Level or Logic Level 6A @ 125V AC or 0.4VA maximum @ 28V AC/DC maximum

Note: This dual rated option is suitable when two or more identical switches are used in logic and in power circuits within the same application. See Supplement section for complete explanation of dual rating and operating range.

PC TERMINALS

03 Straight

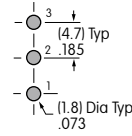
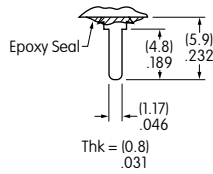

Single Pole

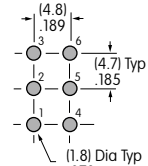

Double Pole

13 Straight with .460" (11.7mm) Bracket

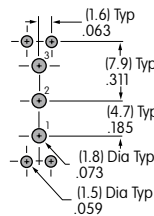
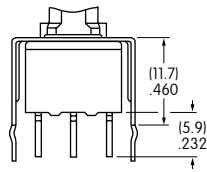

Single Pole

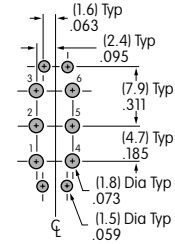

Double Pole

30 .150" (3.81mm) Right Angle

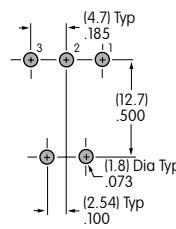
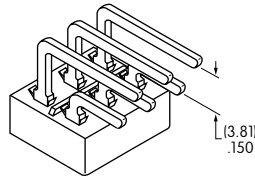

Single Pole

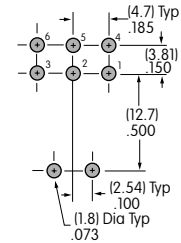

Double Pole

40 .150" (3.81mm) Vertical

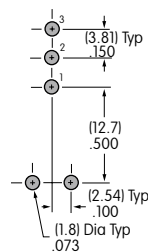
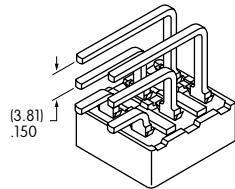

Single Pole

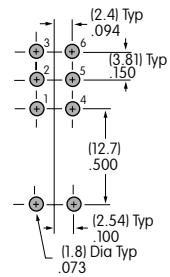

Double Pole

05 .390" (9.9mm) Extended PC

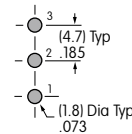
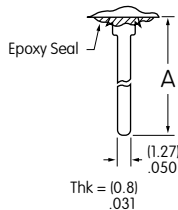

Single Pole

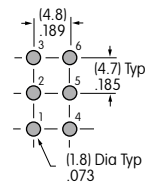

Double Pole

06 .728" (18.5mm) Extended PC

07 .945" (24.0mm) Extended PC

Dimension A = terminal lengths as shown beside the terminal codes at the left.

TYPICAL SWITCH DIMENSIONS

Single Pole

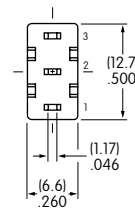
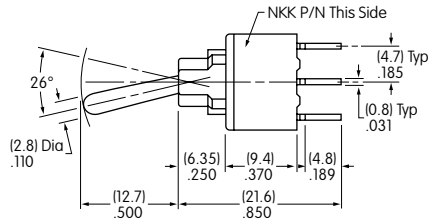
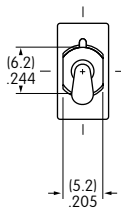

Straight PC



Actuator in Down Position

M2T12SA5G03

Double Pole

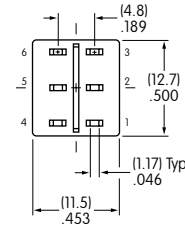
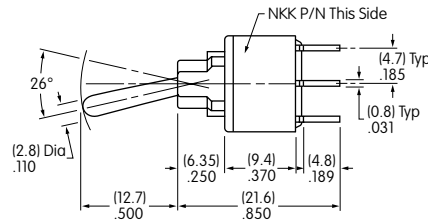
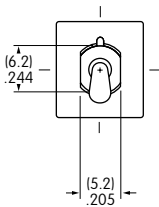

Straight PC



Actuator in Down Position

M2T22SA5G03

Single & Double Pole

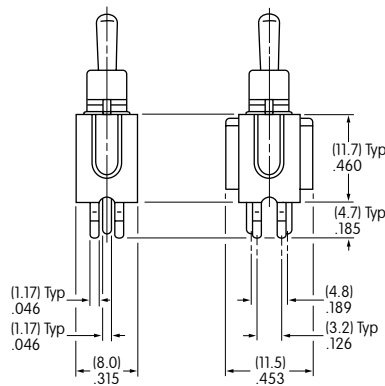
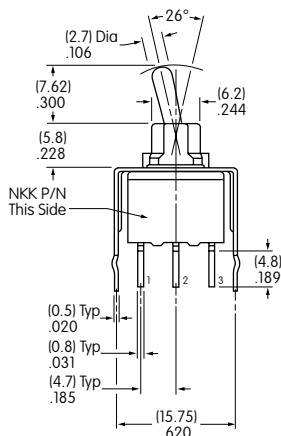

Straight PC • Bracket



Actuator in Down Position

M2T12SA45G13

TYPICAL SWITCH DIMENSIONS

Right Angle PC

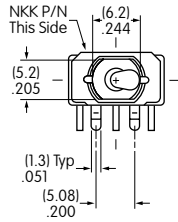

Single Pole

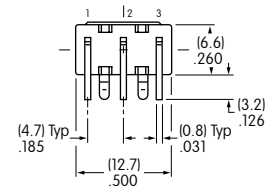
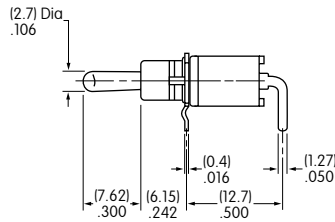

M2T12S4A5G30

Actuator in Down Position

Right Angle PC

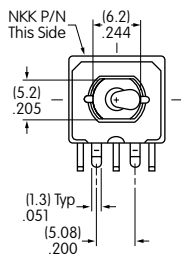

Double Pole

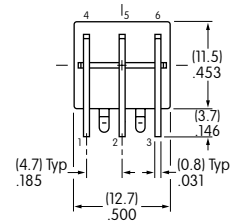
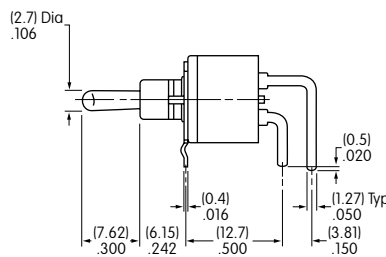

M2T22S4A5G30

Actuator in Down Position

Vertical PC

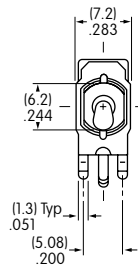

Single Pole

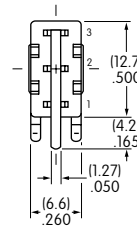
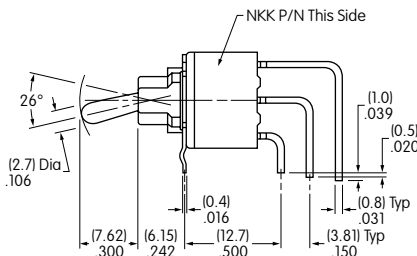

M2T12S4A5G40

Actuator in Down Position

Vertical PC

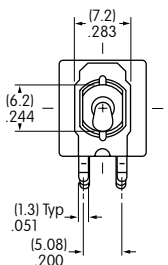

Double Pole

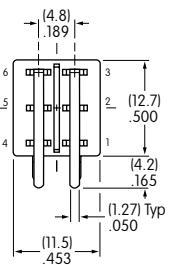
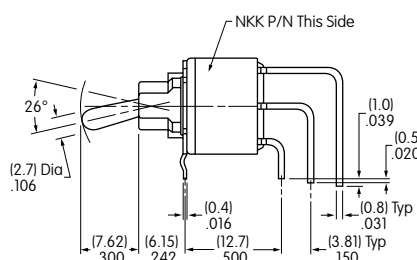

M2T22S4A5G40

Actuator in Down Position

HANDLING PRECAUTION

When an application employs M2T model with silver contacts, 5 to 6A @ 125V AC, and the switch will be actuated 100 or more times per day, note these instructions:

Peel off the film seal on the switch body situated over the part number after cleaning.



Компания «ЭлектроПласт» предлагает заключение долгосрочных отношений при поставках импортных электронных компонентов на взаимовыгодных условиях!

Наши преимущества:

- Оперативные поставки широкого спектра электронных компонентов отечественного и импортного производства напрямую от производителей и с крупнейших мировых складов;
- Поставка более 17-ти миллионов наименований электронных компонентов;
- Поставка сложных, дефицитных, либо снятых с производства позиций;
- Оперативные сроки поставки под заказ (от 5 рабочих дней);
- Экспресс доставка в любую точку России;
- Техническая поддержка проекта, помощь в подборе аналогов, поставка прототипов;
- Система менеджмента качества сертифицирована по Международному стандарту ISO 9001;
- Лицензия ФСБ на осуществление работ с использованием сведений, составляющих государственную тайну;
- Поставка специализированных компонентов (Xilinx, Altera, Analog Devices, Intersil, Interpoint, Microsemi, Aeroflex, Peregrine, Syfer, Eurofarad, Texas Instrument, Miteq, Cobham, E2V, MA-COM, Hittite, Mini-Circuits, General Dynamics и др.);

Помимо этого, одним из направлений компании «ЭлектроПласт» является направление «Источники питания». Мы предлагаем Вам помощь Конструкторского отдела:

- Подбор оптимального решения, техническое обоснование при выборе компонента;
- Подбор аналогов;
- Консультации по применению компонента;
- Поставка образцов и прототипов;
- Техническая поддержка проекта;
- Защита от снятия компонента с производства.



Как с нами связаться

Телефон: 8 (812) 309 58 32 (многоканальный)

Факс: 8 (812) 320-02-42

Электронная почта: org@eplast1.ru

Адрес: 198099, г. Санкт-Петербург, ул. Калинина, дом 2, корпус 4, литера А.