

# MAX6012/6021/6025/ 6030/6041/6045/6050

# Precision, Low-Power, Low-Dropout, SOT23-3 Voltage References

## General Description

The MAX6012/MAX6021/MAX6025/MAX6030/MAX6041/MAX6045/MAX6050 precision, low-dropout, micropower voltage references are available in miniature SOT23-3 surface-mount packages. They feature a proprietary curvature-correction circuit and laser-trimmed thin-film resistors that result in a low temperature coefficient of <math><15\text{ppm}/^\circ\text{C}</math> and initial accuracy of better than 0.2%. These devices are specified over the extended temperature range.

These series-mode voltage references draw only 27 $\mu\text{A}$  of quiescent supply current and can sink or source up to 500 $\mu\text{A}$  of load current. Unlike conventional shunt-mode (two-terminal) references that waste supply current and require an external resistor, devices in the MAX6012 family offer a supply current that's virtually independent of supply voltage (with only a 0.8 $\mu\text{A}/\text{V}$  variation with supply voltage) and do not require an external resistor. Additionally, these internally compensated devices do not require an external compensation capacitor and are stable with up to 2.2nF of load capacitance. Eliminating the external compensation capacitor saves valuable board area in space-critical applications. Their low dropout voltage and supply-independent, ultra-low supply current make these devices ideal for battery-operated, low-voltage systems.

## Applications

- Hand-Held Equipment
- Data Acquisition Systems
- Industrial and Process-Control Systems
- Battery-Operated Equipment
- Hard-Disk Drives

## Selector Guide

PART	OUTPUT VOLTAGE (V)	INPUT VOLTAGE (V)
MAX6012	1.247	2.5 to 12.6
MAX6021	2.048	2.5 to 12.6
MAX6025	2.500	( $V_{\text{OUT}} + 200\text{mV}$ ) to 12.6
MAX6030	3.000	( $V_{\text{OUT}} + 200\text{mV}$ ) to 12.6
MAX6041	4.096	( $V_{\text{OUT}} + 200\text{mV}$ ) to 12.6
MAX6045	4.500	( $V_{\text{OUT}} + 200\text{mV}$ ) to 12.6
MAX6050	5.000	( $V_{\text{OUT}} + 200\text{mV}$ ) to 12.6

Pin Configuration appears at end of data sheet.

## Features

- 0.2% (max) Initial Accuracy
- 15ppm/ $^\circ\text{C}$  (max) Temperature Coefficient
- 35 $\mu\text{A}$  (max) Quiescent Supply Current
- 0.8 $\mu\text{A}/\text{V}$  Supply Current Variation with  $V_{\text{IN}}$
- $\pm 500\mu\text{A}$  Output Source and Sink Current
- 100mV Dropout at 500 $\mu\text{A}$  Load Current
- 0.12 $\mu\text{V}/\mu\text{A}$  Load Regulation
- 8 $\mu\text{V}/\text{V}$  Line Regulation
- Stable with  $C_{\text{LOAD}} = 0$  to 2.2nF

## Ordering Information

PART	TEMP RANGE	PIN-PACKAGE	TOP MARK
MAX6012AEUR-T	-40 $^\circ\text{C}$ to +85 $^\circ\text{C}$	3 SOT23-3	FZAP
MAX6012BEUR-T	-40 $^\circ\text{C}$ to +85 $^\circ\text{C}$	3 SOT23-3	FZDA
MAX6021AEUR-T	-40 $^\circ\text{C}$ to +85 $^\circ\text{C}$	3 SOT23-3	FZAU
MAX6021BEUR-T	-40 $^\circ\text{C}$ to +85 $^\circ\text{C}$	3 SOT23-3	FZDF
MAX6025AEUR-T	-40 $^\circ\text{C}$ to +85 $^\circ\text{C}$	3 SOT23-3	FZAQ
MAX6025BEUR-T	-40 $^\circ\text{C}$ to +85 $^\circ\text{C}$	3 SOT23-3	FZDB
MAX6030AEUR-T	-40 $^\circ\text{C}$ to +85 $^\circ\text{C}$	3 SOT23-3	FZDW
MAX6030BEUR-T	-40 $^\circ\text{C}$ to +85 $^\circ\text{C}$	3 SOT23-3	FZDX
MAX6041AEUR-T	-40 $^\circ\text{C}$ to +85 $^\circ\text{C}$	3 SOT23-3	FZAR
MAX6041BEUR-T	-40 $^\circ\text{C}$ to +85 $^\circ\text{C}$	3 SOT23-3	FZDC
MAX6045AEUR-T	-40 $^\circ\text{C}$ to +85 $^\circ\text{C}$	3 SOT23-3	FZAS
MAX6045BEUR-T	-40 $^\circ\text{C}$ to +85 $^\circ\text{C}$	3 SOT23-3	FZDD
MAX6050AEUR-T	-40 $^\circ\text{C}$ to +85 $^\circ\text{C}$	3 SOT23-3	FZAT
MAX6050BEUR-T	-40 $^\circ\text{C}$ to +85 $^\circ\text{C}$	3 SOT23-3	FZDE

## Typical Operating Circuit

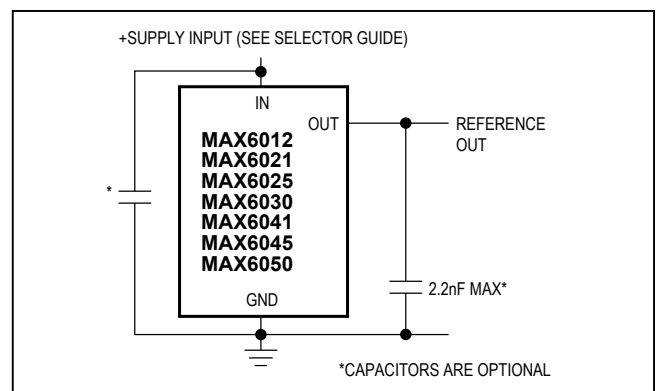

### Absolute Maximum Ratings

(Voltages Referenced to GND)

IN	-0.3V to +13.5V
OUT	-0.3V to ( $V_{IN} + 0.3V$ )
Output Short Circuit to GND or IN ( $V_{IN} < 6V$ )	Continuous
Output Short Circuit to GND or IN ( $V_{IN} \geq 6V$ )	60s

Continuous Power Dissipation ( $T_A = +70^\circ C$ )

3-Pin SOT23-3 (derate 4.0mW/°C above +70°C)	320mW
Operating Temperature Range	-40°C to +85°C
Storage Temperature Range	-65°C to +150°C
Lead Temperature (soldering, 10s)	+300°C

Stresses beyond those listed under "Absolute Maximum Ratings" may cause permanent damage to the device. These are stress ratings only, and functional operation of the device at these or any other conditions beyond those indicated in the operational sections of the specifications is not implied. Exposure to absolute maximum rating conditions for extended periods may affect device reliability.

### Electrical Characteristics—MAX6012

( $V_{IN} = +5V$ ,  $I_{OUT} = 0$ ,  $T_A = T_{MIN}$  to  $T_{MAX}$ , unless otherwise noted. Typical values are at  $T_A = +25^\circ C$ .) (Note 1)

PARAMETER	SYMBOL	CONDITIONS	MIN	TYP	MAX	UNITS	
<b>OUTPUT</b>							
Output Voltage	$V_{OUT}$	$T_A = +25^\circ C$	MAX6012A	1.243	1.247	1.251	V
				-0.32		0.32	%
			MAX6012B	1.241	1.247	1.253	V
				-0.48		0.48	%
Output Voltage Temperature Coefficient (Note 2)	$V_{OUT}$	$T_A = 0^\circ C$ to $+70^\circ C$	MAX6012A	6	15	ppm/°C	
		$T_A = -40^\circ C$ to $+85^\circ C$		6	20		
		$T_A = 0^\circ C$ to $+70^\circ C$	MAX6012B	6	25		
		$T_A = -40^\circ C$ to $+85^\circ C$		6	30		
Line Regulation	$\frac{\Delta V_{OUT}}{\Delta V_{IN}}$	$2.5V \leq V_{IN} \leq 12.6V$		8	80	$\mu V/V$	
Load Regulation	$\frac{\Delta V_{OUT}}{\Delta I_{OUT}}$	Sourcing: $0 \leq I_{OUT} \leq 500\mu A$		0.12	0.50	$\mu V/\mu A$	
		Sinking: $-500\mu A \leq I_{OUT} \leq 0$		0.15	0.60		
OUT Short-Circuit Current	$I_{SC}$	Short to GND		4		mA	
		Short to IN		4			
Temperature Hysteresis (Note 3)				130		ppm	
Long-Term Stability	$\frac{\Delta V_{OUT}}{\text{time}}$	1000hr at $T_A = +25^\circ C$		50		ppm/1000h	
<b>DYNAMIC</b>							
Noise Voltage	$e_{OUT}$	$f = 0.1Hz$ to $10Hz$		12		$\mu Vp-p$	
		$f = 10Hz$ to $10kHz$		65		$\mu V_{RMS}$	
Ripple Rejection	$\frac{\Delta V_{OUT}}{\Delta V_{IN}}$	$V_{IN} = 5V \pm 100mV$ , $f = 120Hz$		86		dB	
Turn-On Settling Time	$t_R$	To $V_{OUT} = 0.1\%$ of final value, $C_{OUT} = 50pF$		30		$\mu s$	
Capacitive-Load Stability Range	$C_{OUT}$	Note 4	0		2.2	nF	
<b>INPUT</b>							
Supply Voltage Range	$V_{IN}$	Guaranteed by line-regulation test	2.5		12.6	V	
Quiescent Supply Current	$I_{IN}$			27	35	$\mu A$	
Change in Supply Current	$I_{IN}/V_{IN}$	$2.5V \leq V_{IN} \leq 12.6V$		0.8	2.0	$\mu A/V$	

### Electrical Characteristics—MAX6021

( $V_{IN} = +5V$ ,  $I_{OUT} = 0$ ,  $T_A = T_{MIN}$  to  $T_{MAX}$ , unless otherwise noted. Typical values are at  $T_A = +25^\circ C$ .) (Note 1)

PARAMETER	SYMBOL	CONDITIONS	MIN	TYP	MAX	UNITS	
<b>OUTPUT</b>							
Output Voltage	$V_{OUT}$	$T_A = +25^\circ C$	MAX6021A	2.043	2.048	2.053	V
				-0.24		0.24	%
			MAX6021B	2.040	2.048	2.056	V
				-0.39		0.39	%
Output Voltage Temperature Coefficient (Note 2)	$V_{OUT}$	$T_A = 0^\circ C$ to $+70^\circ C$	MAX6021A	6	15	ppm/ $^\circ C$	
		$T_A = -40^\circ C$ to $+85^\circ C$		6	20		
		$T_A = 0^\circ C$ to $+70^\circ C$	MAX6021B	6	25		
		$T_A = -40^\circ C$ to $+85^\circ C$		6	30		
Line Regulation	$\frac{\Delta V_{OUT}}{\Delta V_{IN}}$	$2.5V \leq V_{IN} \leq 12.6V$		10	100	$\mu V/V$	
Load Regulation	$\frac{\Delta V_{OUT}}{\Delta I_{OUT}}$	Sourcing: $0 \leq I_{OUT} \leq 500\mu A$		0.12	0.55	$\mu V/\mu A$	
		Sinking: $-500\mu A \leq I_{OUT} \leq 0$		0.18	0.70		
OUT Short-Circuit Current	$I_{SC}$	Short to GND		4		mA	
		Short to IN		4			
Temperature Hysteresis (Note 3)				130		ppm	
Long-Term Stability	$\frac{\Delta V_{OUT}}{\text{time}}$	1000hr at $T_A = +25^\circ C$		50		ppm/1000h	
<b>DYNAMIC</b>							
Noise Voltage	$e_{OUT}$	$f = 0.1\text{Hz}$ to $10\text{Hz}$		35		$\mu V_{p-p}$	
		$f = 10\text{Hz}$ to $10\text{kHz}$		105		$\mu V_{RMS}$	
Ripple Rejection	$\frac{\Delta V_{OUT}}{\Delta V_{IN}}$	$V_{IN} = 5V \pm 100\text{mV}$ , $f = 120\text{Hz}$		84		dB	
Turn-On Settling Time	$t_R$	To $V_{OUT} = 0.1\%$ of final value, $C_{OUT} = 50\text{pF}$		70		$\mu s$	
Capacitive-Load Stability Range	$C_{OUT}$	Note 4	0		2.2	nF	
<b>INPUT</b>							
Supply Voltage Range	$V_{IN}$	Guaranteed by line-regulation test	2.5		12.6	V	
Quiescent Supply Current	$I_{IN}$			27	35	$\mu A$	
Change in Supply Current	$I_{IN}/V_{IN}$	$2.5V \leq V_{IN} \leq 12.6V$		0.8	2.0	$\mu A/V$	

**Electrical Characteristics—MAX6025**

( $V_{IN} = +5V$ ,  $I_{OUT} = 0$ ,  $T_A = T_{MIN}$  to  $T_{MAX}$ , unless otherwise noted. Typical values are at  $T_A = +25^\circ C$ .) (Note 1)

PARAMETER	SYMBOL	CONDITIONS	MIN	TYP	MAX	UNITS	
<b>OUTPUT</b>							
Output Voltage	$V_{OUT}$	$T_A = +25^\circ C$	MAX6025A	2.495	2.500	2.505	V
				-0.20		0.20	%
			MAX6025B	2.490	2.500	2.510	V
				-0.40		0.40	%
Output Voltage Temperature Coefficient (Note 2)	$V_{OUT}$	$T_A = 0^\circ C$ to $+70^\circ C$	MAX6025A	6	15	ppm/ $^\circ C$	
		$T_A = -40^\circ C$ to $+85^\circ C$		6	20		
		$T_A = 0^\circ C$ to $+70^\circ C$	MAX6025B	6	25		
		$T_A = -40^\circ C$ to $+85^\circ C$		6	30		
Line Regulation	$\frac{\Delta V_{OUT}}{\Delta V_{IN}}$	$(V_{OUT} + 0.2V) \leq V_{IN} \leq 12.6V$		15	140	$\mu V/V$	
Load Regulation	$\frac{\Delta V_{OUT}}{\Delta I_{OUT}}$	Sourcing: $0 \leq I_{OUT} \leq 500\mu A$		0.14	0.60	$\mu V/\mu A$	
		Sinking: $-500\mu A \leq I_{OUT} \leq 0$		0.18	0.80		
Dropout Voltage (Note 5)	$V_{IN} - V_{OUT}$	$I_{OUT} = 500\mu A$		100	200	mV	
OUT Short-Circuit Current	$I_{SC}$	Short to GND		4		mA	
		Short to IN		4			
Temperature Hysteresis (Note 3)	$\frac{\Delta V_{OUT}}{\text{time}}$			130		ppm	
Long-Term Stability	$\frac{\Delta V_{OUT}}{\text{time}}$	1000hr at $T_A = +25^\circ C$		50		ppm/1000h	
<b>DYNAMIC</b>							
Noise Voltage	$e_{OUT}$	$f = 0.1\text{Hz}$ to $10\text{Hz}$		50		$\mu V_{p-p}$	
		$f = 10\text{Hz}$ to $10\text{kHz}$		125		$\mu V_{RMS}$	
Ripple Rejection	$\frac{\Delta V_{OUT}}{\Delta V_{IN}}$	$V_{IN} = 5V \pm 100\text{mV}$ , $f = 120\text{Hz}$		82		dB	
Turn-On Settling Time	$t_R$	To $V_{OUT} = 0.1\%$ of final value, $C_{OUT} = 50\text{pF}$		85		$\mu s$	
Capacitive-Load Stability Range	$C_{OUT}$	Note 4	0		2.2	nF	
<b>INPUT</b>							
Supply Voltage Range	$V_{IN}$	Guaranteed by line-regulation test	$V_{OUT} + 0.2$		12.6	V	
Quiescent Supply Current	$I_{IN}$			27	35	$\mu A$	
Change in Supply Current	$I_{IN}/V_{IN}$	$2.5V \leq V_{IN} \leq 12.6V$		0.8	2.0	$\mu A/V$	

**Electrical Characteristics—MAX6030**

( $V_{IN} = +5V$ ,  $I_{OUT} = 0$ ,  $T_A = T_{MIN}$  to  $T_{MAX}$ , unless otherwise noted. Typical values are at  $T_A = +25^\circ C$ .) (Note 1)

PARAMETER	SYMBOL	CONDITIONS	MIN	TYP	MAX	UNITS	
<b>OUTPUT</b>							
Output Voltage	$V_{OUT}$	$T_A = +25^\circ C$	MAX6030A	2.994	3.000	3.006	V
				-0.20		0.20	%
			MAX6030B	2.988	3.000	3.012	V
				-0.40		0.40	%
Output Voltage Temperature Coefficient (Note 2)	$V_{OUT}$	$T_A = 0^\circ C$ to $+70^\circ C$	MAX6030A		6	15	ppm/ $^\circ C$
		$T_A = -40^\circ C$ to $+85^\circ C$			6	20	
		$T_A = 0^\circ C$ to $+70^\circ C$	MAX6030B		6	25	
		$T_A = -40^\circ C$ to $+85^\circ C$			6	30	
Line Regulation	$\frac{\Delta V_{OUT}}{\Delta V_{IN}}$	$(V_{OUT} + 0.2V) \leq V_{IN} \leq 12.6V$		20	150	$\mu V/V$	
Load Regulation	$\frac{\Delta V_{OUT}}{\Delta I_{OUT}}$	Sourcing: $0 \leq I_{OUT} \leq 500\mu A$		0.14	0.60	$\mu V/\mu A$	
		Sinking: $-500\mu A \leq I_{OUT} \leq 0$		0.18	0.80		
Dropout Voltage (Note 5)	$V_{IN} - V_{OUT}$	$I_{OUT} = 500\mu A$		100	200	mV	
OUT Short-Circuit Current	$I_{SC}$	Short to GND		4		mA	
		Short to IN		4			
Temperature Hysteresis (Note 3)				130		ppm	
Long-Term Stability	$\frac{\Delta V_{OUT}}{\text{time}}$	1000hr at $T_A = +25^\circ C$		50		ppm/1000h	
<b>DYNAMIC</b>							
Noise Voltage	$e_{OUT}$	$f = 0.1\text{Hz}$ to $10\text{Hz}$		65		$\mu V_{p-p}$	
		$f = 10\text{Hz}$ to $10\text{kHz}$		150		$\mu V_{RMS}$	
Ripple Rejection	$\frac{\Delta V_{OUT}}{\Delta V_{IN}}$	$V_{IN} = 5V \pm 100\text{mV}$ , $f = 120\text{Hz}$		80		dB	
Turn-On Settling Time	$t_R$	To $V_{OUT} = 0.1\%$ of final value, $C_{OUT} = 50\text{pF}$		100		$\mu s$	
Capacitive-Load Stability Range	$C_{OUT}$	Note 4	0		2.2	nF	
<b>INPUT</b>							
Supply Voltage Range	$V_{IN}$	Guaranteed by line-regulation test	$V_{OUT} + 0.2$		12.6	V	
Quiescent Supply Current	$I_{IN}$			27	35	$\mu A$	
Change in Supply Current	$I_{IN}/V_{IN}$	$2.5V \leq V_{IN} \leq 12.6V$		0.8	2.0	$\mu A/V$	

### Electrical Characteristics—MAX6041

( $V_{IN} = +5V$ ,  $I_{OUT} = 0$ ,  $T_A = T_{MIN}$  to  $T_{MAX}$ , unless otherwise noted. Typical values are at  $T_A = +25^\circ C$ .) (Note 1)

PARAMETER	SYMBOL	CONDITIONS	MIN	TYP	MAX	UNITS	
<b>OUTPUT</b>							
Output Voltage	$V_{OUT}$	$T_A = +25^\circ C$	MAX6041A	4.088	4.096	4.104	V
				-0.20		0.20	%
			MAX6041B	4.080	4.096	4.112	V
				-0.39		0.39	%
Output Voltage Temperature Coefficient (Note 2)	$V_{OUT}$	$T_A = 0^\circ C$ to $+70^\circ C$	MAX6041A	6	15	ppm/ $^\circ C$	
		$T_A = -40^\circ C$ to $+85^\circ C$		6	20		
		$T_A = 0^\circ C$ to $+70^\circ C$	MAX6041B	6	25		
		$T_A = -40^\circ C$ to $+85^\circ C$		6	30		
Line Regulation	$\frac{\Delta V_{OUT}}{\Delta V_{IN}}$	$(V_{OUT} + 0.2V) \leq V_{IN} \leq 12.6V$		25	160	$\mu V/V$	
Load Regulation	$\frac{\Delta V_{OUT}}{\Delta I_{OUT}}$	Sourcing: $0 \leq I_{OUT} \leq 500\mu A$		0.15	0.70	$\mu V/\mu A$	
		Sinking: $-500\mu A \leq I_{OUT} \leq 0$		0.20	0.90		
Dropout Voltage (Note 5)	$V_{IN} - V_{OUT}$	$I_{OUT} = 500\mu A$		100	200	mV	
OUT Short-Circuit Current	$I_{SC}$	Short to GND		4		mA	
		Short to IN		4			
Temperature Hysteresis (Note 3)	$\frac{\Delta V_{OUT}}{\text{time}}$	1000hr at $T_A = +25^\circ C$		130		ppm	
Long-Term Stability	$\frac{\Delta V_{OUT}}{\text{time}}$	1000hr at $T_A = +25^\circ C$		50		ppm/1000h	
<b>DYNAMIC</b>							
Noise Voltage	$e_{OUT}$	$f = 0.1\text{Hz}$ to $10\text{Hz}$		100		$\mu V_{p-p}$	
		$f = 10\text{Hz}$ to $10\text{kHz}$		200		$\mu V_{RMS}$	
Ripple Rejection	$\frac{\Delta V_{OUT}}{\Delta V_{IN}}$	$V_{IN} = 5V \pm 100\text{mV}$ , $f = 120\text{Hz}$		77		dB	
Turn-On Settling Time	$t_R$	To $V_{OUT} = 0.1\%$ of final value, $C_{OUT} = 50\text{pF}$		160		$\mu s$	
Capacitive-Load Stability Range	$C_{OUT}$	Note 4	0		2.2	nF	
<b>INPUT</b>							
Supply Voltage Range	$V_{IN}$	Guaranteed by line-regulation test	$V_{OUT} + 0.2$		12.6	V	
Quiescent Supply Current	$I_{IN}$			27	35	$\mu A$	
Change in Supply Current	$I_{IN}/V_{IN}$	$2.5V \leq V_{IN} \leq 12.6V$		0.8	2.0	$\mu A/V$	

**Electrical Characteristics—MAX6045**

( $V_{IN} = +5V$ ,  $I_{OUT} = 0$ ,  $T_A = T_{MIN}$  to  $T_{MAX}$ , unless otherwise noted. Typical values are at  $T_A = +25^\circ C$ .) (Note 1)

PARAMETER	SYMBOL	CONDITIONS	MIN	TYP	MAX	UNITS	
<b>OUTPUT</b>							
Output Voltage	$V_{OUT}$	$T_A = +25^\circ C$	MAX6045A	4.491	4.500	4.509	V
				-0.20		0.20	%
			MAX6045B	4.482	4.500	4.518	V
				-0.40		0.40	%
Output Voltage Temperature Coefficient (Note 2)	$V_{OUT}$	$T_A = 0^\circ C$ to $+70^\circ C$	MAX6045A	6	15	ppm/ $^\circ C$	
		$T_A = -40^\circ C$ to $+85^\circ C$		6	20		
		$T_A = 0^\circ C$ to $+70^\circ C$	MAX6045B	6	25		
		$T_A = -40^\circ C$ to $+85^\circ C$		6	30		
Line Regulation	$\frac{\Delta V_{OUT}}{\Delta V_{IN}}$	$(V_{OUT} + 0.2V) \leq V_{IN} \leq 12.6V$		25	160	$\mu V/V$	
Load Regulation	$\frac{\Delta V_{OUT}}{\Delta I_{OUT}}$	Sourcing: $0 \leq I_{OUT} \leq 500\mu A$		0.16	0.80	$\mu V/\mu A$	
		Sinking: $-500\mu A \leq I_{OUT} \leq 0$		0.22	1.00		
Dropout Voltage (Note 5)	$V_{IN} - V_{OUT}$	$I_{OUT} = 500\mu A$		100	200	mV	
OUT Short-Circuit Current	$I_{SC}$	Short to GND		4		mA	
		Short to IN		4			
Temperature Hysteresis (Note 3)	$\frac{\Delta V_{OUT}}{\text{time}}$			130		ppm	
Long-Term Stability	$\frac{\Delta V_{OUT}}{\text{time}}$	1000hr at $T_A = +25^\circ C$		50		ppm/1000h	
<b>DYNAMIC</b>							
Noise Voltage	$e_{OUT}$	$f = 0.1\text{Hz}$ to $10\text{Hz}$		110		$\mu V_{p-p}$	
		$f = 10\text{Hz}$ to $10\text{kHz}$		215		$\mu V_{RMS}$	
Ripple Rejection	$\frac{\Delta V_{OUT}}{\Delta V_{IN}}$	$V_{IN} = 5V \pm 100\text{mV}$ , $f = 120\text{Hz}$		76		dB	
Turn-On Settling Time	$t_R$	To $V_{OUT} = 0.1\%$ of final value, $C_{OUT} = 50\text{pF}$		180		$\mu s$	
Capacitive-Load Stability Range	$C_{OUT}$	Note 4	0		2.2	nF	
<b>INPUT</b>							
Supply Voltage Range	$V_{IN}$	Guaranteed by line-regulation test	$V_{OUT} + 0.2$		12.6	V	
Quiescent Supply Current	$I_{IN}$			27	35	$\mu A$	
Change in Supply Current	$I_{IN}/V_{IN}$	$2.5V \leq V_{IN} \leq 12.6V$		0.8	2.0	$\mu A/V$	

### Electrical Characteristics—MAX6050

( $V_{IN} = +5V$ ,  $I_{OUT} = 0$ ,  $T_A = T_{MIN}$  to  $T_{MAX}$ , unless otherwise noted. Typical values are at  $T_A = +25^\circ C$ .) (Note 1)

PARAMETER	SYMBOL	CONDITIONS	MIN	TYP	MAX	UNITS	
<b>OUTPUT</b>							
Output Voltage	$V_{OUT}$	$T_A = +25^\circ C$	MAX6050A	4.990	5.000	5.010	V
				-0.20		0.20	%
			MAX6050B	4.980	5.000	5.020	V
				-0.40		0.40	%
Output Voltage Temperature Coefficient (Note 2)	$TCV_{OUT}$	$T_A = 0^\circ C$ to $+70^\circ C$	MAX6050A		6	15	ppm/ $^\circ C$
				$T_A = -40^\circ C$ to $+85^\circ C$		6	
		$T_A = 0^\circ C$ to $+70^\circ C$	MAX6050B		6	25	
				$T_A = -40^\circ C$ to $+85^\circ C$		6	
Line Regulation	$\frac{\Delta V_{OUT}}{\Delta V_{IN}}$	$(V_{OUT} + 0.2V) \leq V_{IN} \leq 12.6V$		25	160	$\mu V/V$	
Load Regulation	$\frac{\Delta V_{OUT}}{\Delta I_{OUT}}$	Sourcing: $0 \leq I_{OUT} \leq 500\mu A$		0.17	0.85	$\mu V/\mu A$	
		Sinking: $-500\mu A \leq I_{OUT} \leq 0$		0.24	1.10		
Dropout Voltage (Note 5)	$V_{IN} - V_{OUT}$	$I_{OUT} = 500\mu A$		100	200	mV	
OUT Short-Circuit Current	$I_{SC}$	Short to GND		4		mA	
		Short to IN		4			
Temperature Hysteresis (Note 3)				130		ppm	
Long-Term Stability	$\frac{\Delta V_{OUT}}{\text{time}}$	1000hr at $T_A = +25^\circ C$		50		ppm/1000h	
<b>DYNAMIC</b>							
Noise Voltage	$e_{OUT}$	$f = 0.1\text{Hz}$ to $10\text{Hz}$		120		$\mu V_{p-p}$	
		$f = 10\text{Hz}$ to $10\text{kHz}$		240		$\mu V_{RMS}$	
Ripple Rejection	$\frac{\Delta V_{OUT}}{\Delta V_{IN}}$	$V_{IN} = 5V \pm 100\text{mV}$ , $f = 120\text{Hz}$		72		dB	
Turn-On Settling Time	$t_R$	To $V_{OUT} = 0.1\%$ of final value, $C_{OUT} = 50\text{pF}$		220		$\mu s$	
Capacitive-Load Stability Range	$C_{OUT}$	Note 4	0		2.2	nF	
<b>INPUT</b>							
Supply Voltage Range	$V_{IN}$	Guaranteed by line-regulation test	$V_{OUT} + 0.2$		12.6	V	
Quiescent Supply Current	$I_{IN}$			27	35	$\mu A$	
Change in Supply Current	$I_{IN}/V_{IN}$	$2.5V \leq V_{IN} \leq 12.6V$		0.8	2.0	$\mu A/V$	

**Note 1:** All devices are 100% production tested at  $T_A = +25^\circ C$  and are guaranteed by design for  $T_A = T_{MIN}$  to  $T_{MAX}$ , as specified.

**Note 2:** Temperature Coefficient is measured by the "box" method, i.e., the maximum  $\Delta V_{OUT}$  is divided by the maximum  $\Delta t$ .

**Note 3:** Temperature Hysteresis is defined as the change in  $+25^\circ C$  output voltage before and after cycling the device from  $T_{MIN}$  to  $T_{MAX}$ .

**Note 4:** Not production tested. Guaranteed by design.

**Note 5:** Dropout voltage is the minimum input voltage at which  $V_{OUT}$  changes  $\leq 0.2\%$  from  $V_{OUT}$  at  $V_{IN} = 5.0V$  ( $V_{IN} = 5.5V$  for MAX6050).



Typical Operating Characteristics

( $V_{IN} = +5V$  for MAX6012/21/25/30/41/45,  $V_{IN} = +5.5V$  for MAX6050;  $I_{OUT} = 0$ ;  $T_A = +25^\circ C$ ; unless otherwise noted.) (Note 6)

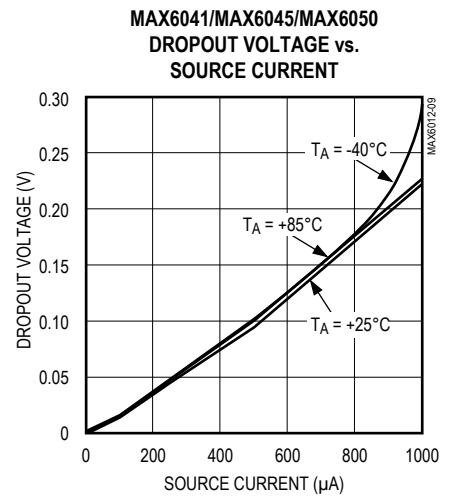
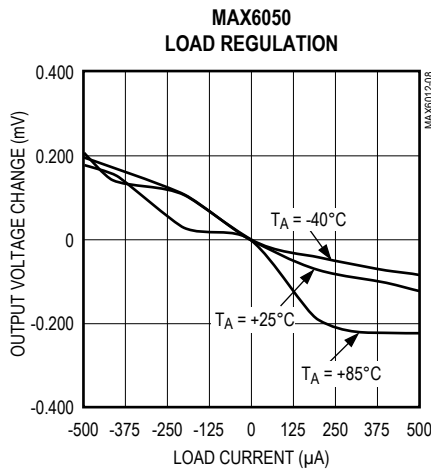
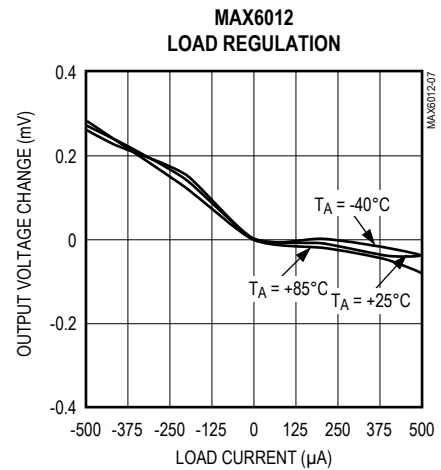
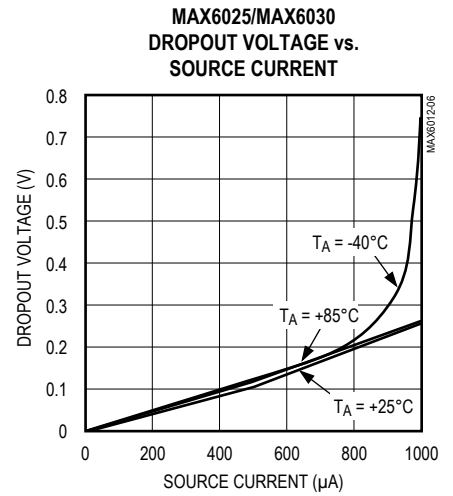
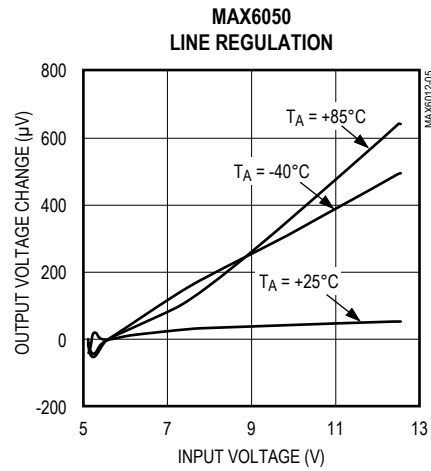
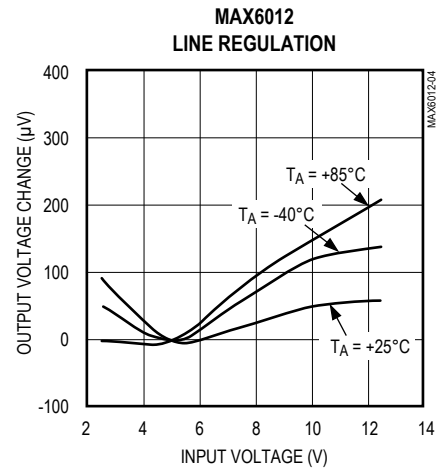
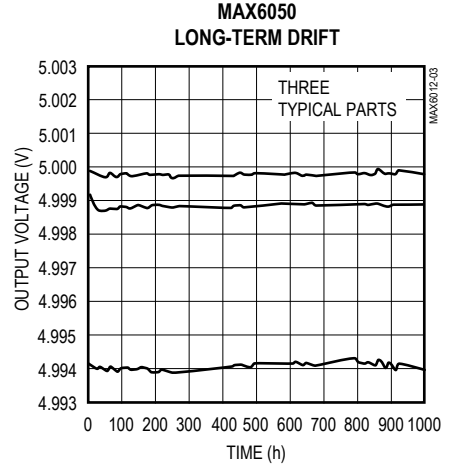
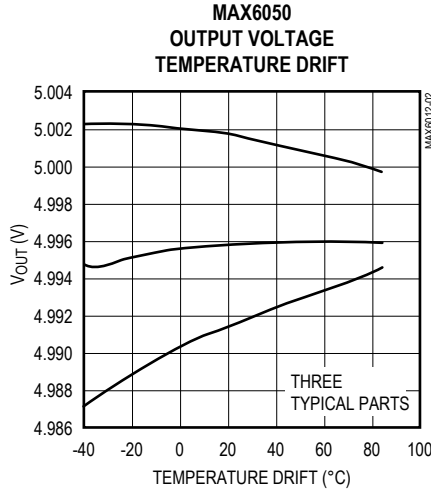
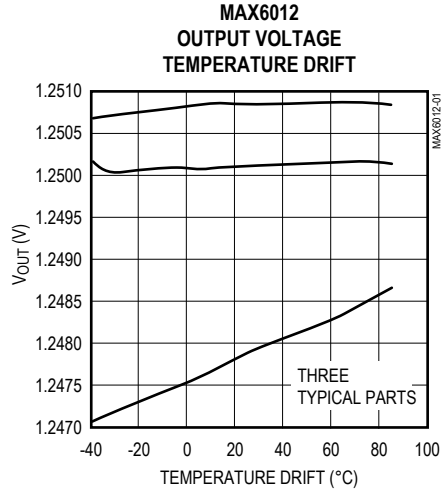

Typical Operating Characteristics (continued)

( $V_{IN} = +5V$  for MAX6012/21/25/30/41/45,  $V_{IN} = +5.5V$  for MAX6050;  $I_{OUT} = 0$ ;  $T_A = +25^\circ C$ ; unless otherwise noted.) (Note 6)

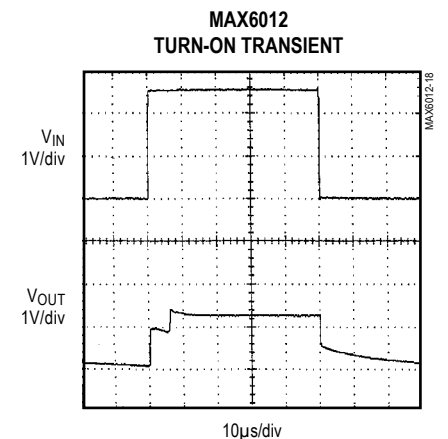
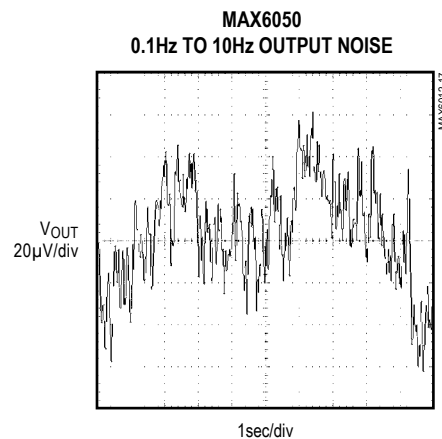
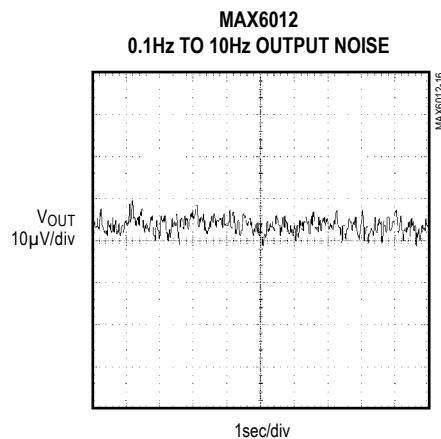
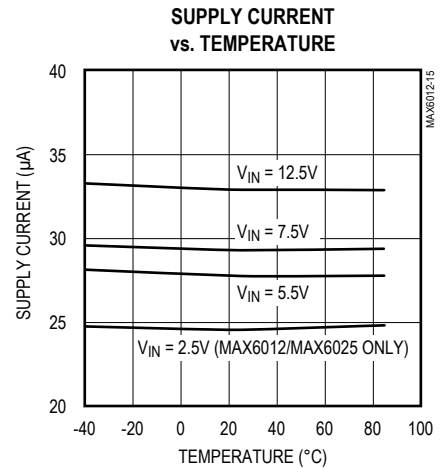
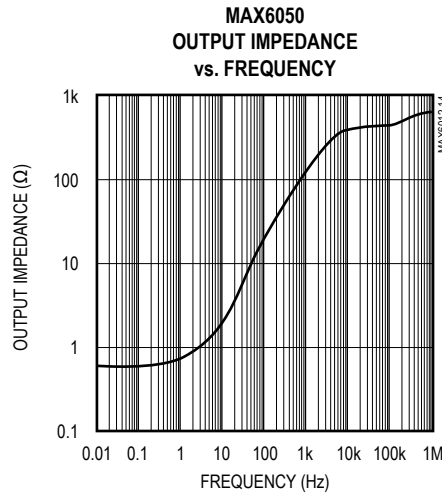
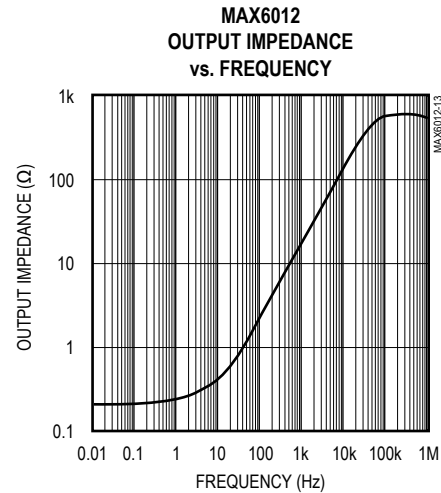
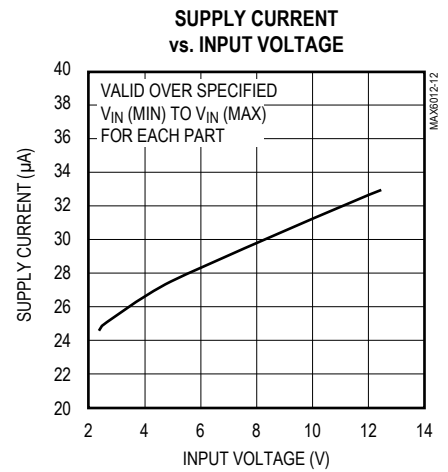
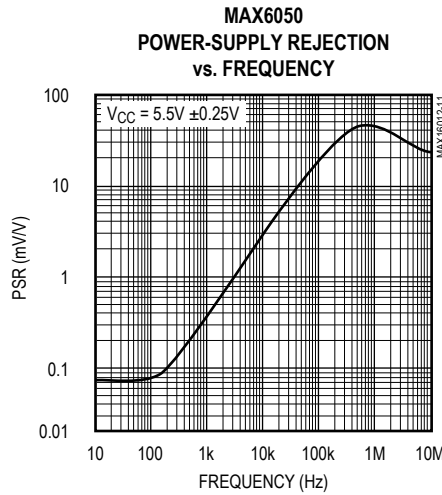
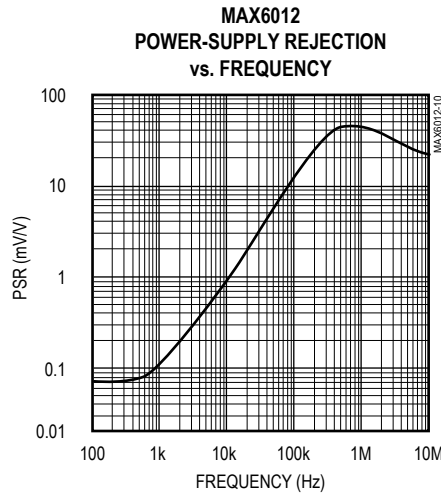

Typical Operating Characteristics (continued)

( $V_{IN} = +5V$  for MAX6012/21/25/30/41/45,  $V_{IN} = +5.5V$  for MAX6050;  $I_{OUT} = 0$ ;  $T_A = +25^\circ C$ ; unless otherwise noted.) (Note 6)

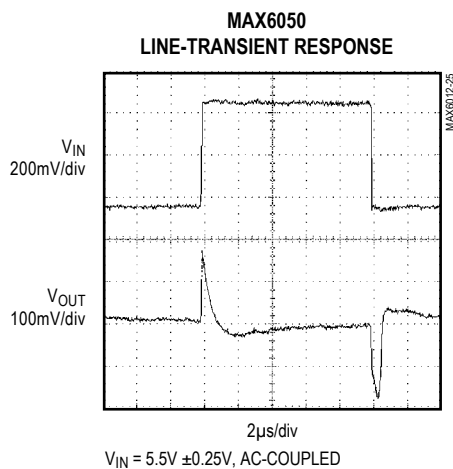
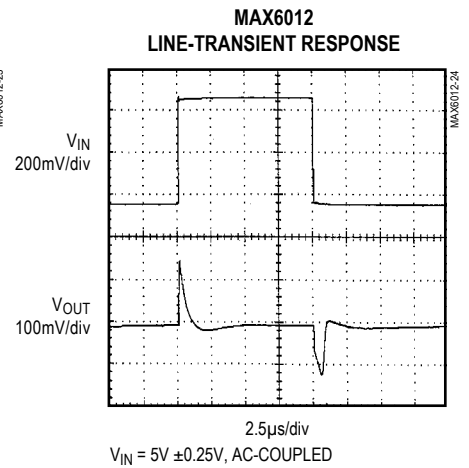
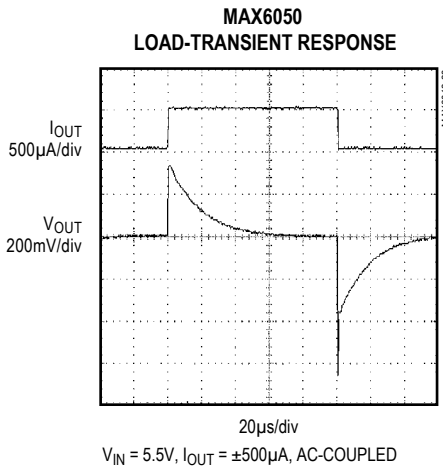
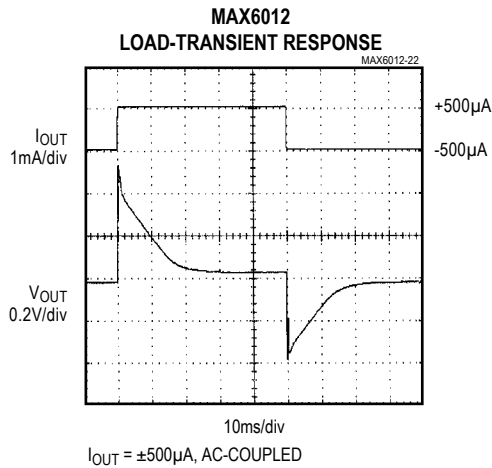
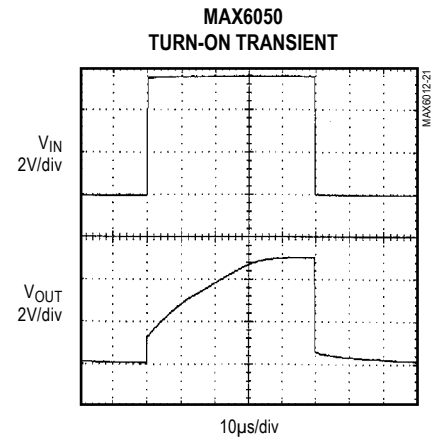
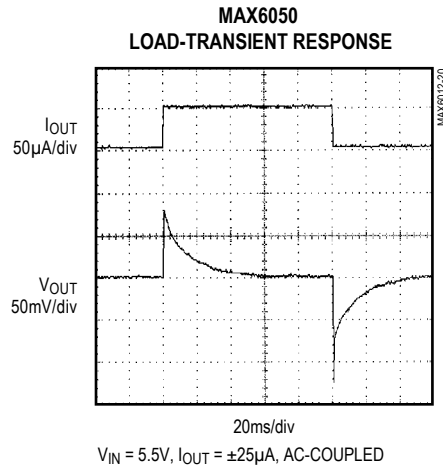
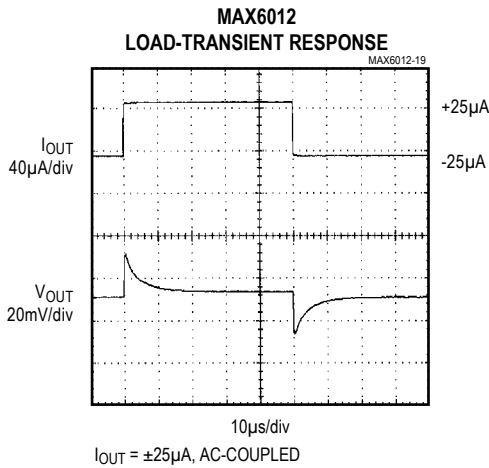

**Note 6:** Many of the *Typical Operating Characteristics* of the MAX6012 family are extremely similar. The extremes of these characteristics are found in the MAX6012 (1.2V output) and the MAX6050 (5.0V output). The *Typical Operating Characteristics* of the remainder of the MAX6012 family typically lie between these two extremes and can be estimated based on their output voltage.

## Pin Description

PIN	NAME	FUNCTION
1	IN	Supply Voltage Input
2	OUT	Reference Voltage Output
3	GND	Ground

## Detailed Description

The MAX6012/MAX6021/MAX6025/MAX6030/MAX6041/MAX6045/MAX6050 precision bandgap references use a proprietary curvature-correction circuit and laser-trimmed thin-film resistors, resulting in a low temperature coefficient of <math><20\text{ppm}/^\circ\text{C}</math> and initial accuracy of better than 0.2%. These devices can sink and source up to 500 $\mu\text{A}$  with <math><200\text{mV}</math> of dropout voltage, making them attractive for use in low-voltage applications.

## Applications Information

### Output/Load Capacitance

Devices in this family do not require an output capacitance for frequency stability. They are stable for capacitive loads from 0 to 2.2nF. However, in applications where the load or the supply can experience step changes, an output capacitor will reduce the amount of overshoot (or undershoot) and assist the circuit's transient response. Many applications do not need an external capacitor, and this family can offer a significant advantage in these applications when board space is critical.

## Supply Current

The quiescent supply current of these series-mode references is a maximum of 35 $\mu\text{A}$  and is virtually independent of the supply voltage, with only a 0.8 $\mu\text{A}/\text{V}$  variation with supply voltage. Unlike series references, shunt-mode references operate with a series resistor connected to the power supply. The quiescent current of a shunt-mode reference is thus a function of the input voltage. Additionally, shunt-mode references have to be biased at the maximum expected load current, even if the load current is not present all the time. The load current is drawn from the input voltage only when required, so supply current is not wasted and efficiency is maximized at all input voltages. This improved efficiency can help reduce power dissipation and extend battery life.

When the supply voltage is below the minimum specified input voltage (as during turn-on), the devices can draw up to 200 $\mu\text{A}$  beyond the nominal supply current. The input voltage source must be capable of providing this current to ensure reliable turn-on.

## Output Voltage Hysteresis

Output voltage hysteresis is the change in the output voltage at  $T_A = +25^\circ\text{C}$  before and after the device is cycled over its entire operating temperature range. Hysteresis is caused by differential package stress appearing across the bandgap core transistors. The typical temperature hysteresis value is 130ppm.

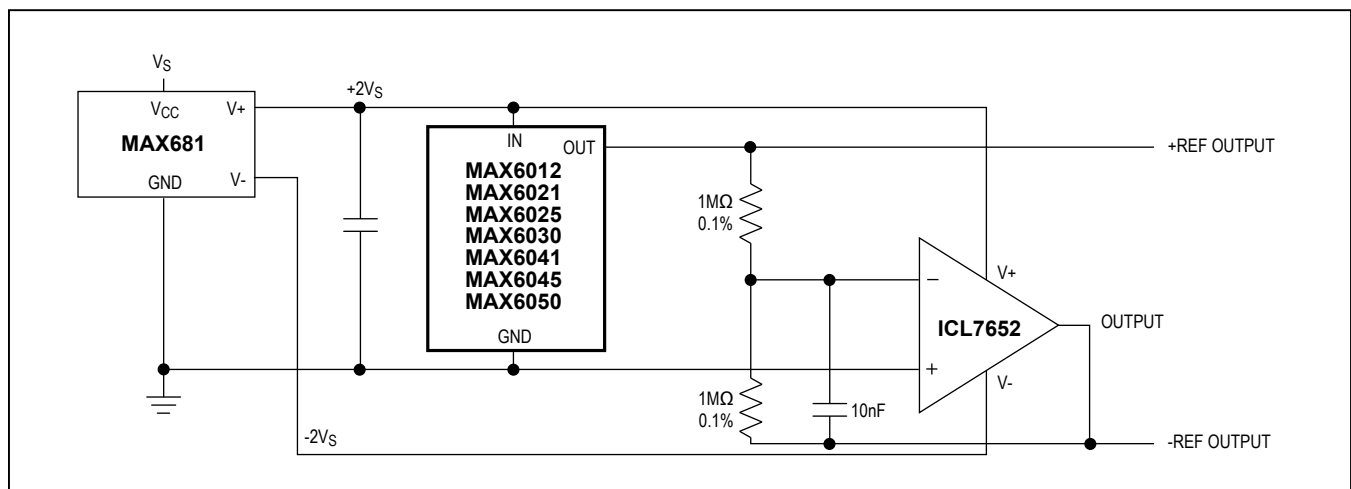

Figure 1. Positive and Negative References from Single +3V or +5V Supply

MAX6012/6021/6025/  
6030/6041/6045/6050

Precision, Low-Power, Low-Dropout,  
SOT23-3 Voltage References

### Turn-On Time

These devices typically turn on and settle to within 0.1% of their final value; 30 $\mu$ s to 220 $\mu$ s depending on the device. The turn-on time can increase up to 1.5ms with the device operating at the minimum dropout voltage and the maximum load.

### Positive and Negative Low-Power Voltage Reference

Figure 1 shows a typical method for developing a bipolar reference. The circuit uses a MAX681 voltage doubler/inverter charge-pump converter to power an ICL7652, thus creating a positive as well as a negative reference voltage.

### Pin Configuration

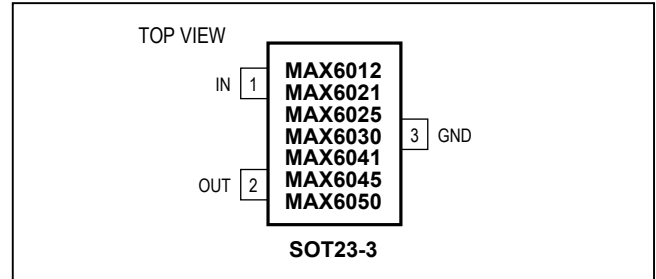

### Chip Information

TRANSISTOR COUNT: 70

### Package Information

For the latest package outline information and land patterns (footprints), go to [www.maximintegrated.com/packages](http://www.maximintegrated.com/packages). Note that a "+", "#", or "-" in the package code indicates RoHS status only. Package drawings may show a different suffix character, but the drawing pertains to the package regardless of RoHS status.

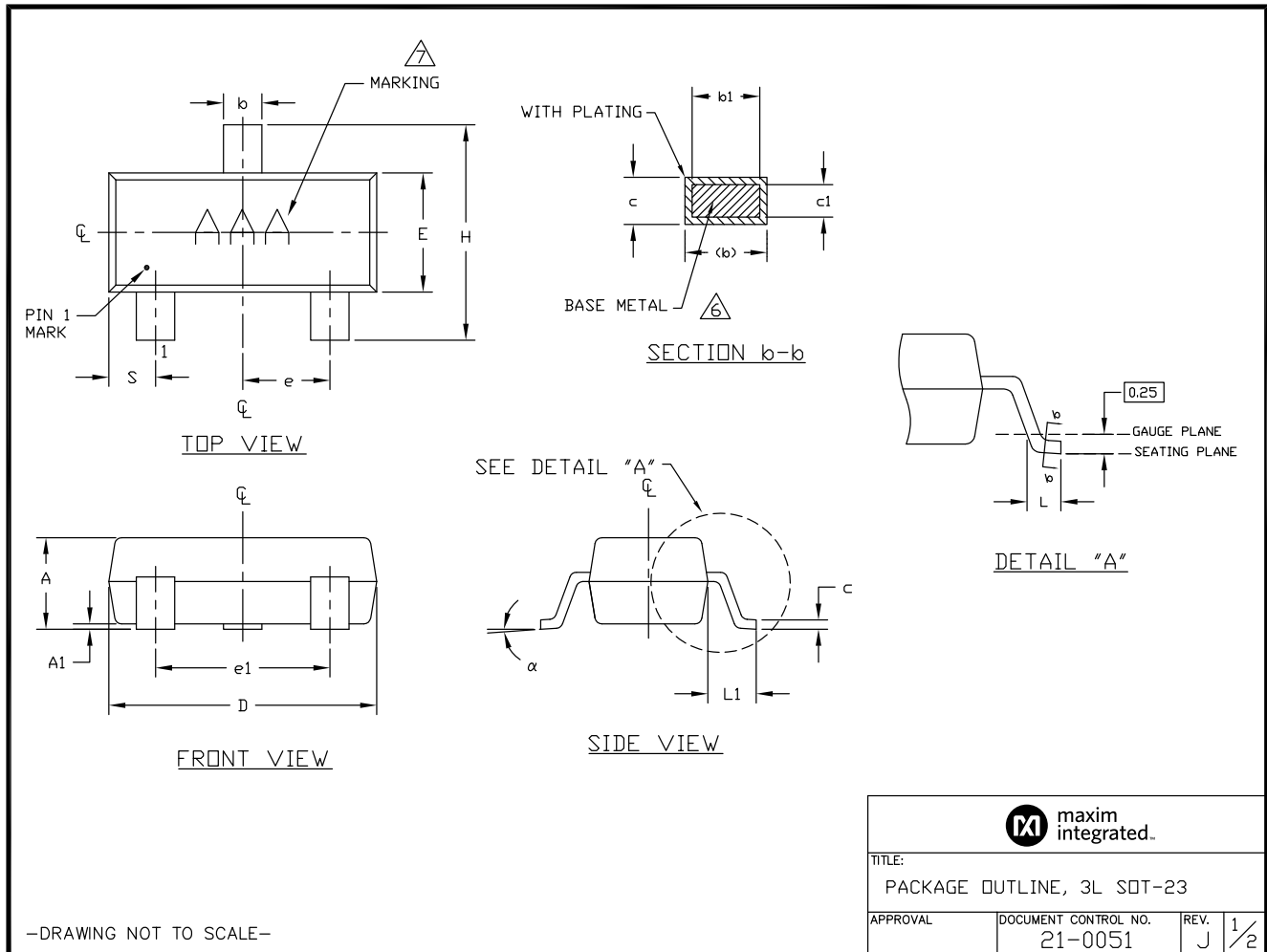

### Package Information

For the latest package outline information and land patterns (footprints), go to [www.maximintegrated.com/packages](http://www.maximintegrated.com/packages). Note that a "+", "#", or "-" in the package code indicates RoHS status only. Package drawings may show a different suffix character, but the drawing pertains to the package regardless of RoHS status.

NOTES:

1. D&E DO NOT INCLUDE MOLD FLASH.
2. MOLD FLASH OR PROTRUSIONS NOT TO EXCEED .15mm (.006").
3. CONTROLLING DIMENSION: MILLIMETERS.
4. REFERENCE JEDEC TO236-VARIATION AB.
5. LEADS TO BE COPLANAR WITHIN 0.10mm.
6. DIMENSIONS MEASURED AT FLAT SECTION OF LEAD BETWEEN 0.08mm AND 0.15mm FROM LEAD TIP.
7. MARKING SHOWN IS FOR PACKAGE ORIENTATION REFERENCE ONLY.
8. MATERIAL MUST COMPLY WITH BANNED AND RESTRICTED SUBSTANCES SPEC # 10-0131.
9. ALL DIMENSIONS APPLY TO BOTH LEADED (-) AND PbFREE (+) PKG. CODES.

DIM	INCHES			MILLIMETERS		
	MIN	NOM	MAX	MIN	NOM	MAX
A	0.035	0.0394	0.044	0.890	1.000	1.120
A1	0.0004	0.0024	0.004	0.010	0.060	0.100
b	0.012	0.0165	0.020	0.300	0.420	0.500
b1	0.012		0.018	0.300		0.450
c	0.003	0.047	0.071	0.085	0.120	0.180
c1	0.003		0.071	0.080		0.160
D	0.110	0.115	0.120	2.800	2.920	3.040
E	0.047	0.0512	0.055	1.200	1.30	1.400
e	0.037 BSC.			0.950 BSC.		
e1	0.075 BSC.			1.900 BSC.		
H	0.083	0.0925	0.104	2.100	2.350	2.640
L	0.015	0.0205	0.023	0.400	0.520	0.600
L1	0.021 REF			0.54 REF		
S	0.018	0.0213	0.024	0.45	0.540	0.60
α	0°	2°	8°	0°	2	8°
PKG CODES: U3-1, U3-2, U3-5						

-DRAWING NOT TO SCALE-

 maxim integrated.			
TITLE: PACKAGE OUTLINE, 3L SOT-23			
APPROVAL	DOCUMENT CONTROL NO. 21-0051	REV. J	2/2

For pricing, delivery, and ordering information, please contact Maxim Direct at 1-888-629-4642, or visit Maxim Integrated's website at [www.maximintegrated.com](http://www.maximintegrated.com).

Maxim Integrated cannot assume responsibility for use of any circuitry other than circuitry entirely embodied in a Maxim Integrated product. No circuit patent licenses are implied. Maxim Integrated reserves the right to change the circuitry and specifications without notice at any time. The parametric values (min and max limits) shown in the Electrical Characteristics table are guaranteed. Other parametric values quoted in this data sheet are provided for guidance.



Компания «ЭлектроПласт» предлагает заключение долгосрочных отношений при поставках импортных электронных компонентов на взаимовыгодных условиях!

Наши преимущества:

- Оперативные поставки широкого спектра электронных компонентов отечественного и импортного производства напрямую от производителей и с крупнейших мировых складов;
- Поставка более 17-ти миллионов наименований электронных компонентов;
- Поставка сложных, дефицитных, либо снятых с производства позиций;
- Оперативные сроки поставки под заказ (от 5 рабочих дней);
- Экспресс доставка в любую точку России;
- Техническая поддержка проекта, помощь в подборе аналогов, поставка прототипов;
- Система менеджмента качества сертифицирована по Международному стандарту ISO 9001;
- Лицензия ФСБ на осуществление работ с использованием сведений, составляющих государственную тайну;
- Поставка специализированных компонентов (Xilinx, Altera, Analog Devices, Intersil, Interpoint, Microsemi, Aeroflex, Peregrine, Syfer, Eurofarad, Texas Instrument, Miteq, Cobham, E2V, MA-COM, Hittite, Mini-Circuits, General Dynamics и др.);

Помимо этого, одним из направлений компании «ЭлектроПласт» является направление «Источники питания». Мы предлагаем Вам помощь Конструкторского отдела:

- Подбор оптимального решения, техническое обоснование при выборе компонента;
- Подбор аналогов;
- Консультации по применению компонента;
- Поставка образцов и прототипов;
- Техническая поддержка проекта;
- Защита от снятия компонента с производства.



#### Как с нами связаться

**Телефон:** 8 (812) 309 58 32 (многоканальный)

**Факс:** 8 (812) 320-02-42

**Электронная почта:** [org@eplast1.ru](mailto:org@eplast1.ru)

**Адрес:** 198099, г. Санкт-Петербург, ул. Калинина, дом 2, корпус 4, литера А.