

General Description

The MIC4834 is a low noise dual Electroluminescent (EL) Panel driver used in backlighting applications. The MIC4834 converts a low DC voltage to a high DC voltage using a boost converter and then alternates the high DC voltage across the EL panels using an H-bridge. The MIC4834 incorporates internal wave-shaping circuitry specifically designed to reduce audible noise emitted by EL panels. With only one inductor the MIC4834 can drive two outputs and requires a minimum number of passive components. It features an operating input voltage range of 2.3V to 5.8V, making it suitable for 1-cell Li-ion and 2- or 3-cell alkaline/NiCad/NiMH battery applications.

The MIC4834 features separate oscillators for the boost and H-bridge stages. The boost frequency may be adjusted with an external resistor to optimize efficiency and brightness. The H-bridge frequency is internally preset to 225Hz, to reduce the number of external components and layout space.

The MIC4834 is available in 10 pin 3mmx3mm MLF[®] package as well as MSOP-10L, and has an operating junction temperature range of -40°C to +125°C.

Features

- Drives two EL panels, up to 3 in² each at full brightness
- 220V_{PP} regulated AC output waveform
- 2.3V to 5.8V DC input voltage
- Wave-shaping circuit to reduce audible noise
- Adjustable boost converter frequency
- Single inductor to power both panels
- 0.1μA typical shutdown current
- Package options
 - 10-pin 3mmx3mm MLF[®]
 - 10-pin MSOP
- -40°C to +125°C junction temperature range

Applications

- Mobile phones
- MP3/portable media players (PMP)
- Clocks/ watches
- Remote controls
- Cordless phones
- GPS devices
- PDAs

Typical Application

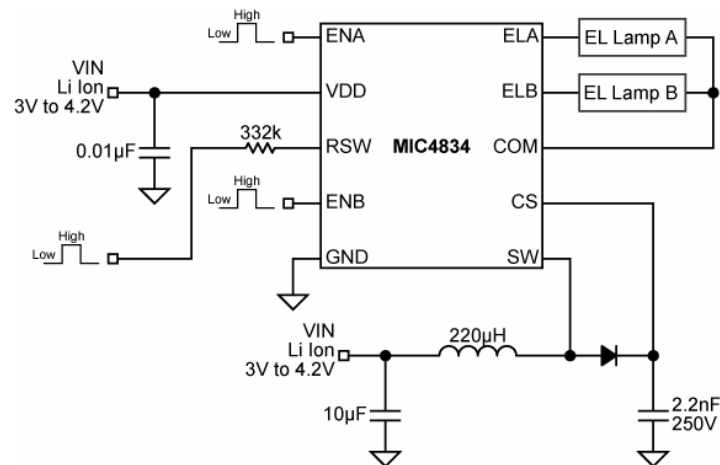

Low Noise Dual EL Driver

Ordering Information

| Part Number | Package | Operating Junction Temp Range | Lead Finish |
|-------------|-------------------------|-------------------------------|--------------------------|
| MIC4834YML | 10 pin (3mm x 3mm) MLF® | -40°C to +125°C | Pb-free / RoHS-Compliant |
| MIC4834YMM | 10-Pin MSOP | -40°C to +125°C | Pb-free / RoHS-Compliant |

Pin Configuration

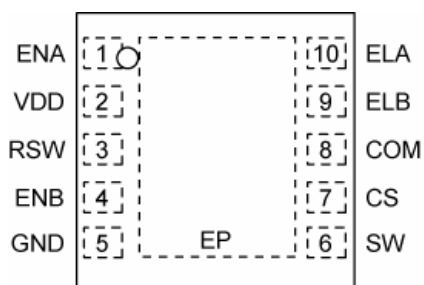

10-Pin MLF® - Top View

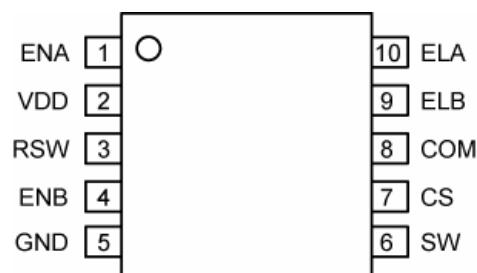

10-Pin MSOP – Top View

Pin Description

| Pin Number | Pin Name | Pin Function |
|------------|----------|--|
| 1 | ENA | EL Panel A Enable Pin: Logic high enables ELA and logic low disables ELA output. |
| 2 | VDD | DC Input Supply Voltage: 2.3V to 5.8V |
| 3 | RSW | RSW pin: Sets internal boost converter switch frequency by connecting an external resistor (R_{SW}) to VDD. Connecting the R_{SW} resistor to GND shuts down the device. |
| 4 | ENB | EL Panel B enable pin: Logic high enables ELB and logic low disables ELB output. |
| 5 | GND | Ground. |
| 6 | SW | Switch Node: Drain of internal high-voltage power MOSFET for boost circuit. |
| 7 | CS | Regulated Boost Output: Connect to the output capacitor of the boost regulator and to the cathode of the diode. |
| 8 | COM | EL output: Common EL output terminal to both ELA and ELB. Connect one end of each EL panel to this pin. |
| 9 | ELB | EL Panel B output: Connect the other end of the EL panel B to this pin. |
| 10 | ELA | EL Panel A output: Connect the other end of the EL panel A to this pin. |
| EPad | HS Pad | Heat Sink Pad. Connect to ground externally. MLF® package only. |

Absolute Maximum Rating⁽¹⁾

| | |
|--|-----------------|
| Supply voltage (V_{DD}) | -0.5V to 6.5V |
| Output voltage (V_{CS}) | -0.5V to 130V |
| Switch Node (V_{SW}) | -0.5V to 130V |
| Enable Voltage ($V_{RSW}, V_{ENA}, V_{ENB}$) | -0.5V to 6.5V |
| Ambient Storage Temperature (T_S) | -65°C to +150°C |
| ESD Rating ⁽³⁾ | ESD Sensitive |

Operating Range⁽²⁾

| | |
|--|-----------------|
| Supply Voltage (V_{DD}) | 2.3V to 5.8V |
| Switching MOSFET Frequency (f_{SW}) | 35kHz to 350kHz |
| Enable Voltage ($V_{RSW}, V_{ENA}, V_{ENB}$) | 0V to V_{DD} |
| Junction Temperature Range (T_J) | -40°C to +125°C |
| Package Thermal Impedance | |
| 3mm x 3mm MLF [®] (θ_{JA}) | 60°C/W |
| MSOP (θ_{JA}) | 206°C/W |

Electrical Characteristics⁽⁴⁾

$T_A = 25^\circ\text{C}$, $V_{DD} = 3.0\text{V}$ unless otherwise noted. **Bold** values indicate $-40^\circ\text{C} \leq T_J \leq 85^\circ\text{C}$.

| Symbol | Parameter | Condition | Min | Typ | Max | Units |
|-------------------------|---------------------------------------|--|------------|-----|-------------|---------------|
| V_{DD} | Supply Voltage Range | | 2.3 | | 5.8 | V |
| I_{DD} | Input Supply Current | $V_{RSW} = \text{High}; V_{CS} = 105\text{V};$ ELA, ELB, COM = Open | | 152 | 220 | μA |
| I_{SD} | Shutdown Current | $V_{RSW} = \text{Low}; V_{DD} = 5.8\text{V}$ | | 0.1 | 1 | μA |
| $R_{DS(ON)}$ | On-resistance Of Switching Transistor | $I_{SW} = 100\text{mA}, V_{CS} = 105\text{V}$ | | 6.0 | 12.0 | Ω |
| V_{CS} | Output voltage Regulation | $V_{DD} = 2.3\text{V to } 5.8\text{v}$ | 90 | 109 | 120 | V |
| f_{SW} | Boost Switching Frequency | $V_{DD} = 3.0\text{V}$ ($R_{SW} = 1.3\text{M}\Omega$) | 25 | 35 | 45 | kHz |
| | | $V_{DD} = 3.0\text{V}$ ($R_{SW} = 450\text{k}\Omega$) | 75 | 100 | 125 | kHz |
| | | $V_{DD} = 3.0\text{V}$ ($R_{SW} = 125\text{k}\Omega$) | 250 | 350 | 450 | kHz |
| f_{EL} | ELA, ELB and COM Drive Frequency | $V_{DD} = 3.0\text{V}$ ELA, ELB, COM = Open | 165 | 225 | 285 | Hz |
| D | Switching Transistor Duty Cycle | | 80 | | 95 | % |
| I_{OUT} | Output Current Drive Limit | | 2.5 | 5 | 7.5 | mA |
| $V_{ENA},$ V_{ENB} | Enable Logic Threshold | | 0.4 | | 1.2 | V |
| V_{HYS} | Enable Logic Hysteresis | | 20 | 50 | 150 | mV |
| $I_{ENA},$ I_{ENB} | Enable Input Current | | | 0.1 | 1 | μA |

Notes:

1. Exceeding the absolute maximum rating may damage the device.
2. The device is not guaranteed to function outside its operating rating.
3. Devices are ESD sensitive. Handling precautions recommended. Human body model, 1.5k Ω in series with 100pF.
4. Specification for packaged product only.

Typical Characteristics

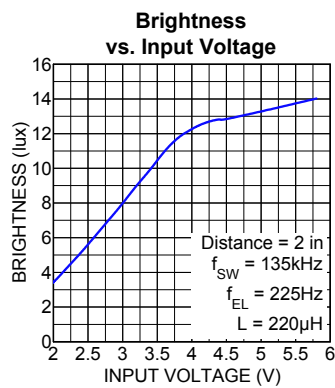
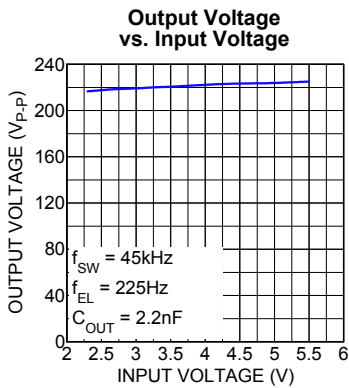
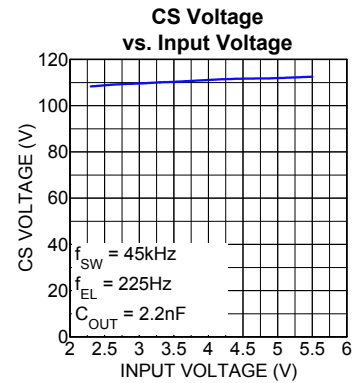
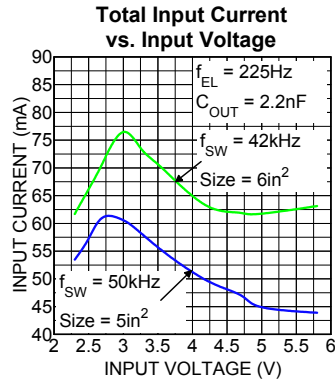
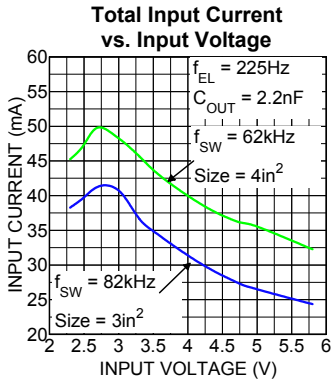
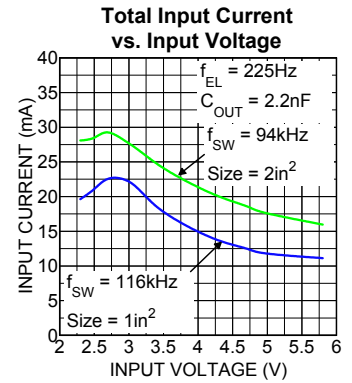
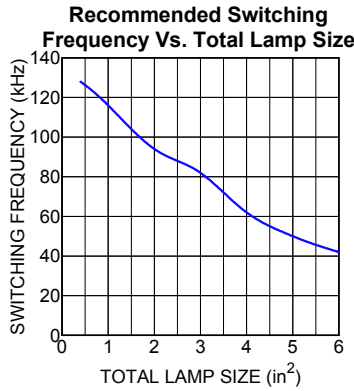
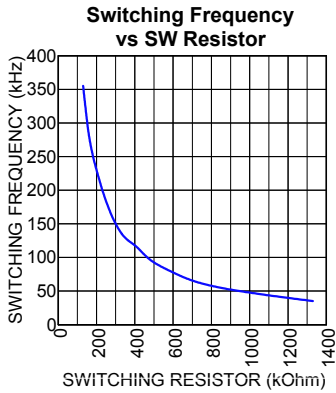

Functional Diagram

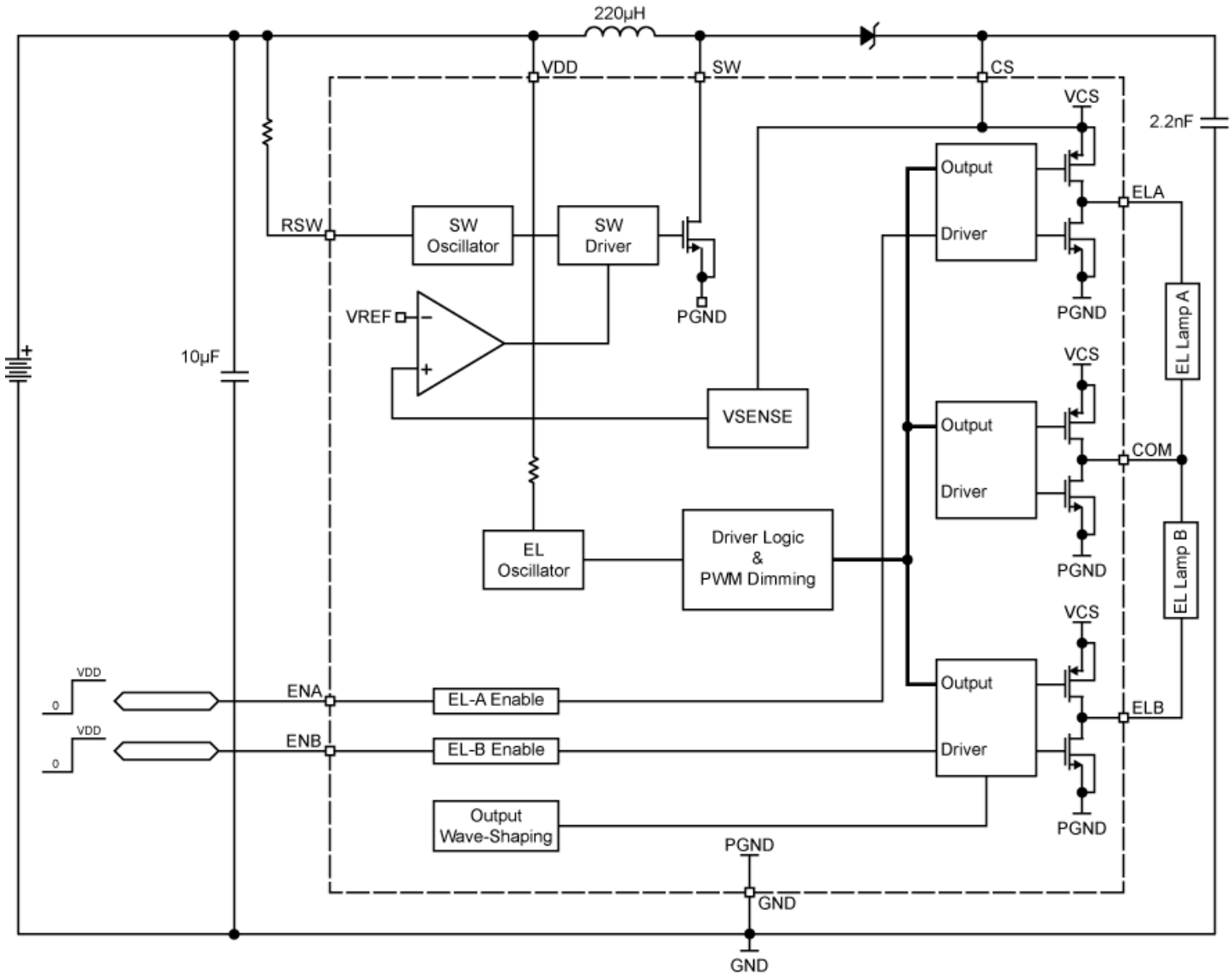

Figure 1. MIC4834 Block Diagram

Functional Description

Overview

The MIC4834 is a high-voltage dual output EL driver with a peak-to-peak AC output voltage of 220V capable of driving two 3 in² EL panels. The MIC4834 drives EL panels by converting a low DC input voltage to a high DC high output voltage using the boost regulator circuit and then alternating the high DC voltage across the EL panel using an H-Bridge. Input supply current for the MIC4834 is typically 152µA. The high voltage EL driver has two internal oscillators to control the boost switching frequency and the H-bridge driver frequency. The internal boost oscillator frequency can be individually

programmed through an external resistor to maximize efficiency and brightness of the EL panel. The H-bridge frequency is internally fixed at 225Hz to reduce external component count.

Regulation

Referring to Figure 1, power is initially applied to V_{DD}. When the internal feedback voltage is less than the reference voltage, the internal comparator enables switching in the boost circuit. When the boost regulator is switching, current flows through the inductor into the switch. The switching MOSFET will typically turn on for 90% of the switching period. During the on-time, energy

is stored in the inductor. When the switching MOSFET turns off, current flowing into the inductor forces the voltage across the inductor to reverse polarity. The voltage across the inductor rises until the external diode conducts and clamps the voltage at $V_{OUT} + V_{D1}$. The energy in the inductor is then discharged into the C_{OUT} capacitor. The internal comparator continues to turn the switching MOSFET on and off until the internal feedback voltage is above the reference voltage. Once the internal feedback voltage is above the reference voltage, the internal comparator disables switching. The control circuit will continue to turn the MOSFET's on and off to maintain a constant DC voltage at the CS pin.

When the MIC4834 EL Driver is enabled, ELA and ELB will switch in opposite states with COM to achieve a 220V peak-to-peak AC output signal needed to drive the two EL panels.

Switching Frequency

The switching frequency of the converter is controlled by an external resistor (R_{SW}) between RSW and VDD. The switching frequency increases as the resistor value decreases. In general, the lower the switching frequency, the greater the input current is drawn to deliver more power to the output. Lowering the switching frequency can be used to drive larger panels. However, the switching frequency should not be so low as to allow the voltage at the switch node or the CS pin to exceed the absolute maximum voltage of those pins. For resistor value selections, see the "Typical Characteristics: Switching Frequency vs. SW Resistor" graph on Page 4 or use the equation below. The switching frequency range is 35kHz to 350kHz, with an accuracy of $\pm 20\%$.

$$f_{SW} \text{ (kHz)} = \frac{46}{R_{SW} \text{ (M}\Omega\text{)}}$$

EL Frequency

The MIC4834 EL panel frequency is internally fixed at 225Hz.

Enable Function

There are a few different ways to enable and disable the MIC4834. The boost regulator may be disabled by pulling the R_{SW} resistor to ground. This turns off both the EL panels by cutting power to the device completely. The R_{SW} resistor must be pulled to VDD to enable the boost oscillator. If it is not equal to VDD, then the frequency set by R_{SW} will be different the programmed value.

For individual panel control, the ENA and ENB pins can be used to enable ELA and ELB, respectively. Pulling

ENA or ENB high (over 1.2V) or low (below 0.4V) will turn ELA and ELB panels on or off.

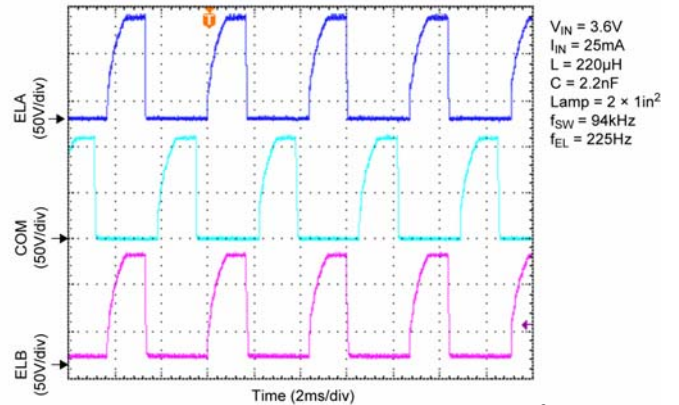

Figure 2. EL Panel Waveform – 2 × 1 in²

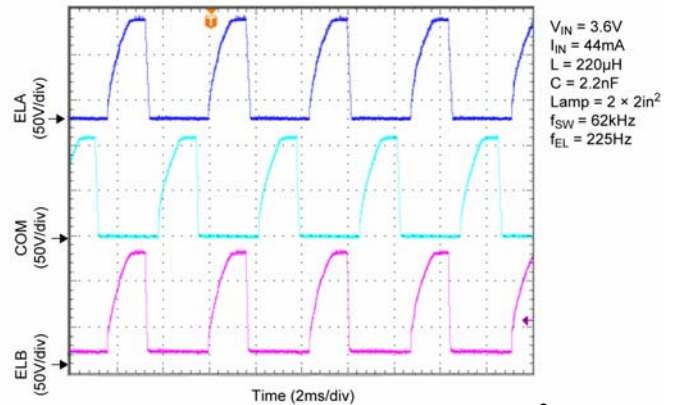

Figure 3. EL Panel Waveform – 2 × 2 in²

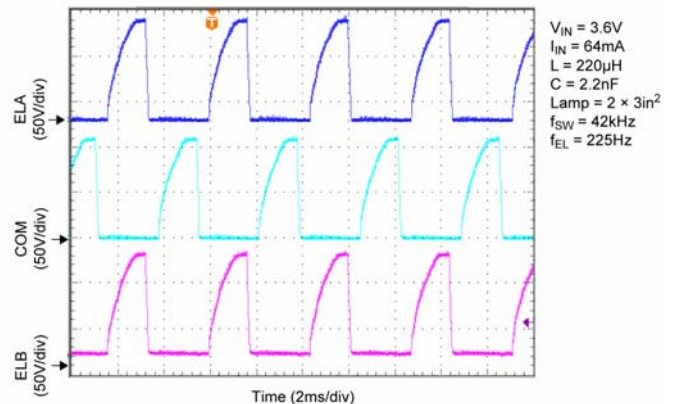

Figure 4. EL Panel Waveform – 2 × 3 in²

Application Information

The MIC4834 is designed to use an inductance with a value between 100 μ H to 330 μ H. Choosing the right inductor is always a balance of size, inductance, efficiency, current rating and cost. A TDK (VLS4012T-221M) 220 μ H inductor is recommended based on size, efficiency and current rating.

Generally, the lower the inductance, the more current the inductor can handle. Lowering the inductance allows the boost regulator to draw more input current to deliver more energy every switching cycle. As a result, a lower inductance may be used to drive larger panels or brighten similar sized panels. However, caution is required as using a low inductance with a low switching frequency may cause the voltage at the switch node and the CS pin to exceed the absolute maximum rating. If the application uses a low input voltage (2.3V to 3V), then a lower value inductor, such as 100 μ H, may be used in order to drive the EL panel at maximum brightness.

Diode

The diode must have a high reverse voltage (150V), since the output voltage at the CS pin can reach up to 130V. A fast switching diode with lower forward voltage and higher reverse voltage (150V), such as BAV20WS/BAS20W, can be used to enhance efficiency.

Output Capacitor

Low ESR capacitors should be used at the regulated boost output (CS pin), to minimize the switching output ripple voltage. The larger the output capacitance, the lower the output ripple at the CS pin. The reduced output ripple, at the CS pin, along with a low ESR capacitor improves the efficiency of the MIC4834 circuit. Selection of the capacitor value depends upon the peak inductor current, inductor size, and the load. The MIC4834 is designed for use with an output capacitance as low as 2.2nF. For minimum audible noise, the use of a C0G/NPO dielectric output capacitor is recommended. TDK and AVX offer C0G/NPO dielectric capacitors in capacitance up to 2.7nF at 200V to 250V voltage rating in 0805 size.

EL Panel Terminals (ELA, ELB, COM)

The two EL panels are connected from ELA to COM and ELB to COM. The ELA and ELB terminals are in phase with each other, while the COM is out of phase with both ELA and ELB. Since ELA and COM are out of phase, the high voltage generated by the boost regulator is alternated across ELA and COM by the H-Bridge. The frequency of each cycle is internally fixed at 225Hz. The alternating 220V peak-to-peak causes the EL panel to emit light. Similarly, the ELB and COM are also out of phase and allows a second EL panel to be driven at the same time. Both EL panels may operate independently from each other and do not have to be the same size. For component selection, Table 2 lists recommended values for various panel sizes up to a total of 6 in² (For example, two 3 in² panels). Driving overly large panels will result in a dimmer display, but will not cause damage to the device.

Application Circuit

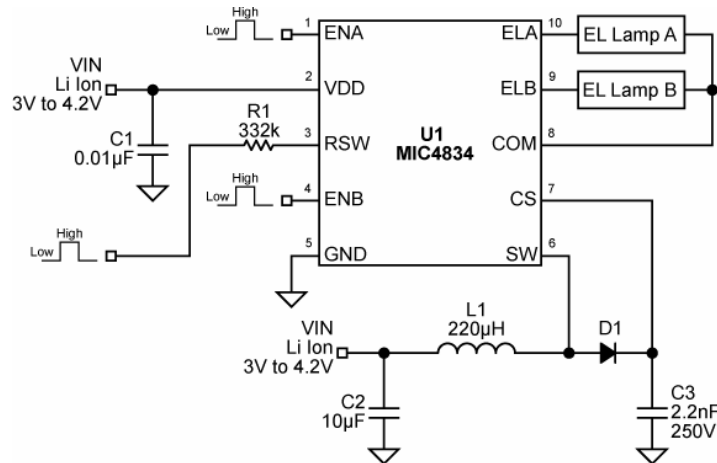

Figure 6. Typical Li-Ion Powered MIC4834 Circuit

Note: Table 2 applies to circuit shown in Figure 6.

| Total Panel Area (in ²) | 0.4 | 1 | 2 | 3 | 4 | 5 | 6 |
|-------------------------------------|-----|-----|-----|-----|-----|-----|------|
| Capacitance (nF) | 2 | 5 | 10 | 15 | 20 | 25 | 30 |
| R _{SW} (kΩ) | 357 | 392 | 487 | 562 | 750 | 931 | 1100 |
| f _{sw} (kHz) | 128 | 116 | 94 | 82 | 62 | 50 | 42 |

Table 2. Recommended R_{SW} Values for Total Panel Sizes

Bill of Materials

| Item | Part Number | Manufacturer | Description | Qty |
|-----------------------|--------------------|-----------------------|---|-----|
| C1 | C1608X7R1A103K | TDK ⁽¹⁾ | 0.01µF Ceramic Capacitor, 10V, X7R, Size 0603 | 1 |
| C2 | C1608X5R0J106K | TDK ⁽¹⁾ | 10 µF Ceramic Capacitor, 6.3V, X5R, Size 0603 | 1 |
| C3 | C2012C0G2E2222J | TDK ⁽¹⁾ | 0.0022µF Ceramic Capacitor, 250V, C0G, Size 0805 | 1 |
| L1 | VLS4012T-221M | TDK ⁽¹⁾ | 220µH, 210mA I _{SAT} . (4mmx4mmx1.2mm) | 1 |
| D1 | BAS20-V-GS18 | Vishay ⁽²⁾ | 200V/200mA Hi-Voltage Switching Diode | 1 |
| R1 or R _{sw} | CRCW06033323FKEYE3 | Vishay ⁽²⁾ | 332kΩ, 1%, 1/16W, Size 0603 | 1 |
| U1 | MIC4834YML | Micrel ⁽³⁾ | Low Noise Dual 220Vp-p EL Driver with Output Slew Control | 1 |

Notes:

1. TDK: www.tdk.com
2. Vishay: www.vishay.com
3. Micrel, Inc.: www.micrel.com

Layout Recommendation (MLF[®])

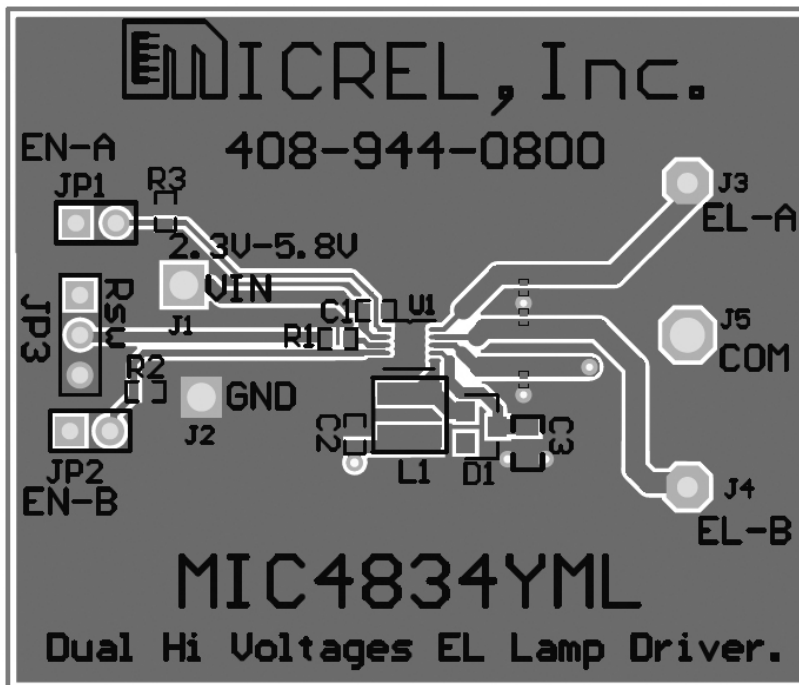

Top Layer

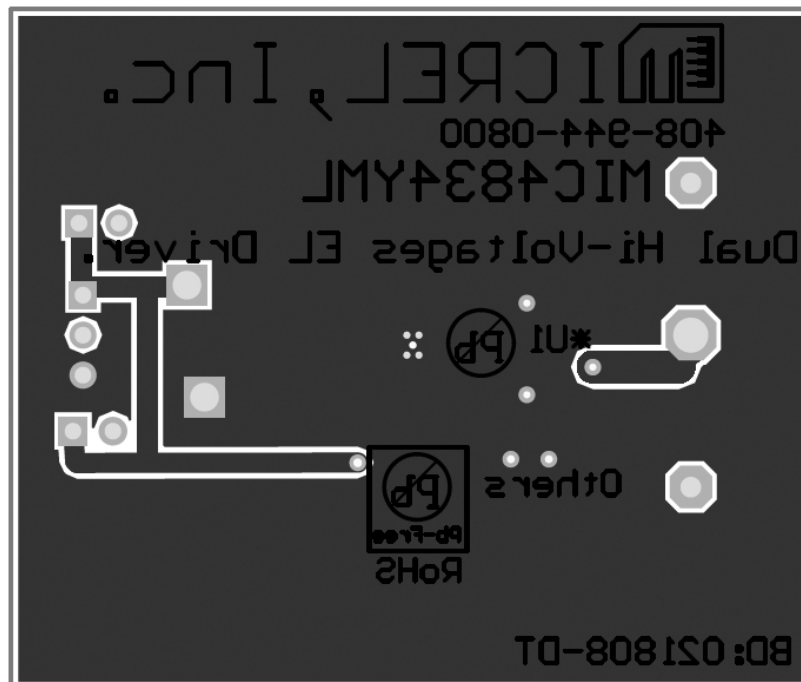

Bottom Layer

Layout Recommendation (MSOP)

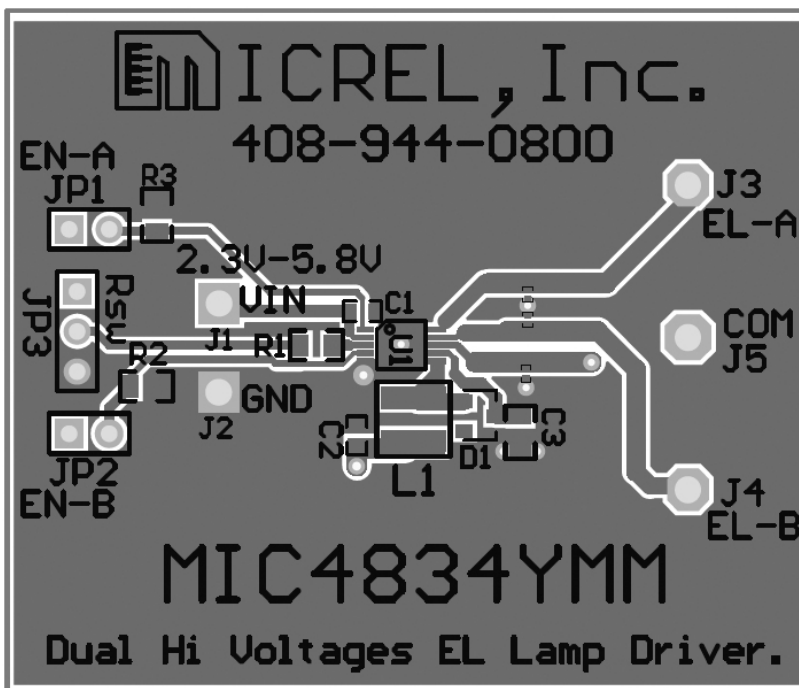

Top Layer

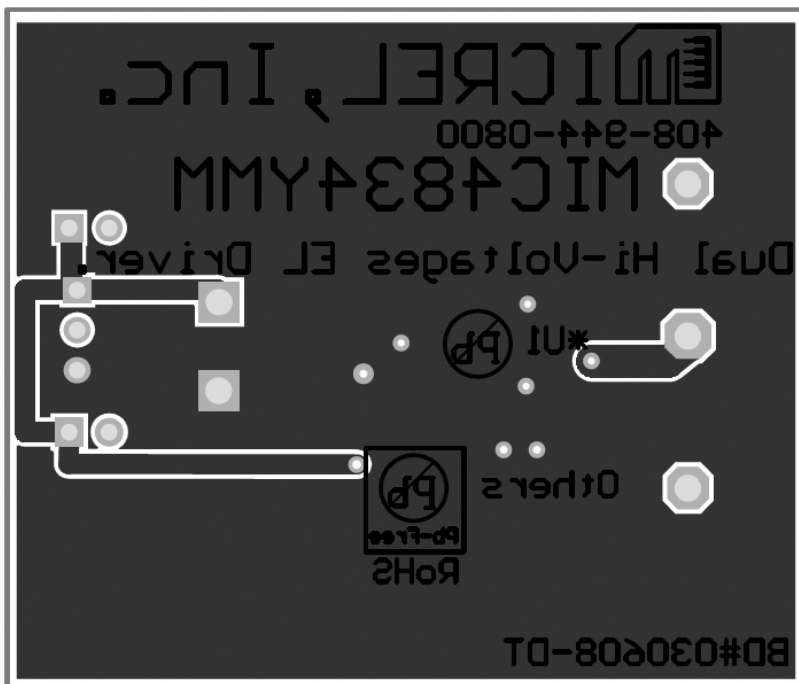

Bottom Layer

Package Information

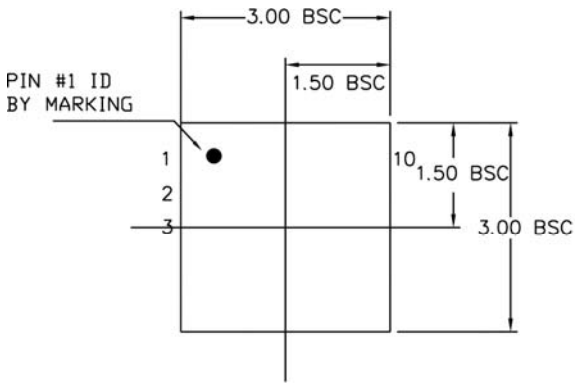

TOP VIEW

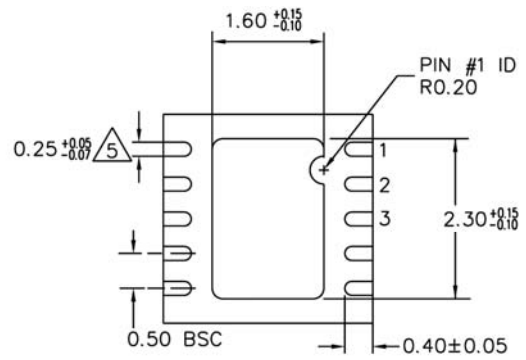

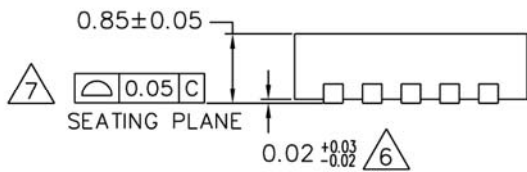

BOTTOM VIEW



SIDE VIEW

NOTE:

1. ALL DIMENSIONS ARE IN MILLIMETERS.
 2. MAX. PACKAGE WARPAGE IS 0.05 mm.
 3. MAXIMUM ALLOWABLE BURRS IS 0.076 mm IN ALL DIRECTIONS.
 4. PIN #1 ID ON TOP WILL BE LASER/INK MARKED.
-  DIMENSION APPLIES TO METALIZED TERMINAL AND IS MEASURED BETWEEN 0.20 AND 0.25 mm FROM TERMINAL TIP.
 APPLIED ONLY FOR TERMINALS.
 APPLIED FOR EXPOSED PAD AND TERMINALS.

10-Pin 3mm x 3mm MLF[®] (ML)

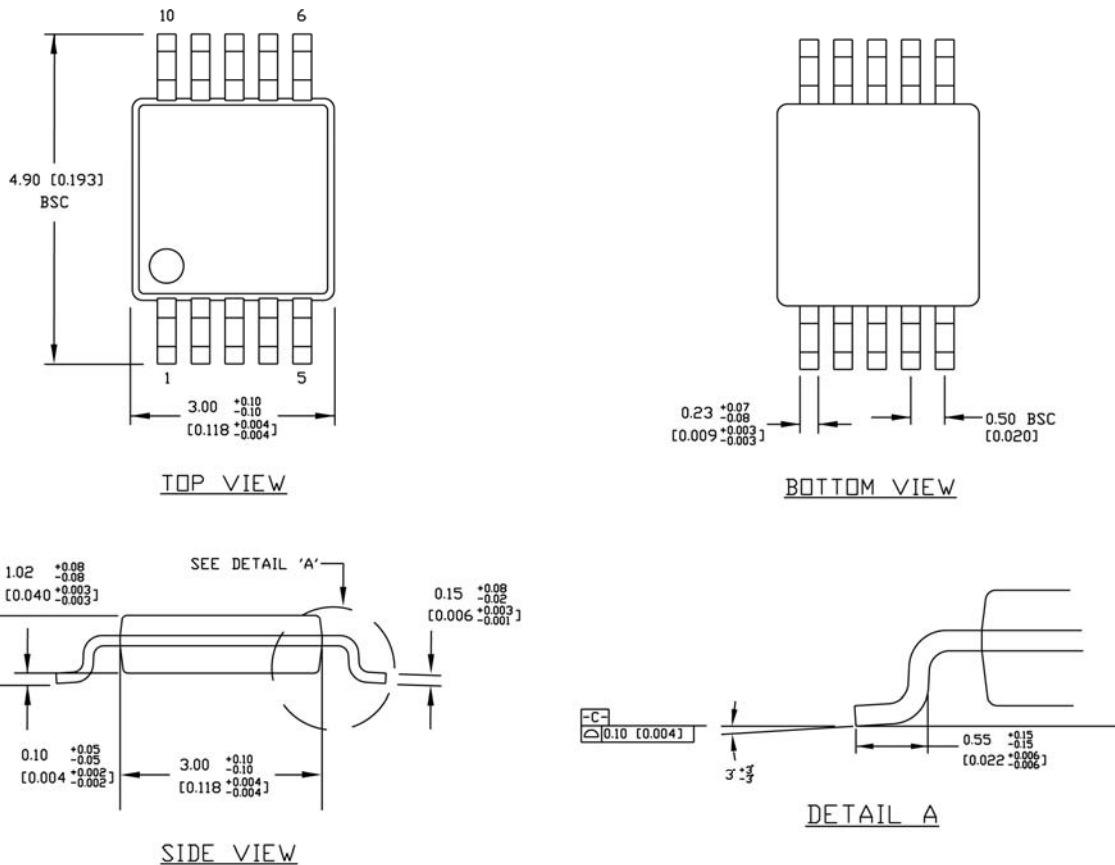

NOTES:

1. DIMENSIONS ARE IN MM [INCHES].
2. CONTROLLING DIMENSION: MM
3. DIMENSION DOES NOT INCLUDE MOLD FLASH OR PROTRUSIONS, EITHER OF WHICH SHALL NOT EXCEED 0.20 [0.008] PER SIDE.

10-Pin MSOP (MM)

MICREL, INC. 2180 FORTUNE DRIVE SAN JOSE, CA 95131 USA
 TEL +1 (408) 944-0800 FAX +1 (408) 474-1000 WEB <http://www.micrel.com>

The information furnished by Micrel in this data sheet is believed to be accurate and reliable. However, no responsibility is assumed by Micrel for its use. Micrel reserves the right to change circuitry and specifications at any time without notification to the customer.

Micrel Products are not designed or authorized for use as components in life support appliances, devices or systems where malfunction of a product can reasonably be expected to result in personal injury. Life support devices or systems are devices or systems that (a) are intended for surgical implant into the body or (b) support or sustain life, and whose failure to perform can be reasonably expected to result in a significant injury to the user. A Purchaser's use or sale of Micrel Products for use in life support appliances, devices or systems is a Purchaser's own risk and Purchaser agrees to fully indemnify Micrel for any damages resulting from such use or sale.

© 2008 Micrel, Incorporated.



Компания «ЭлектроПласт» предлагает заключение долгосрочных отношений при поставках импортных электронных компонентов на взаимовыгодных условиях!

Наши преимущества:

- Оперативные поставки широкого спектра электронных компонентов отечественного и импортного производства напрямую от производителей и с крупнейших мировых складов;
- Поставка более 17-ти миллионов наименований электронных компонентов;
- Поставка сложных, дефицитных, либо снятых с производства позиций;
- Оперативные сроки поставки под заказ (от 5 рабочих дней);
- Экспресс доставка в любую точку России;
- Техническая поддержка проекта, помощь в подборе аналогов, поставка прототипов;
- Система менеджмента качества сертифицирована по Международному стандарту ISO 9001;
- Лицензия ФСБ на осуществление работ с использованием сведений, составляющих государственную тайну;
- Поставка специализированных компонентов (Xilinx, Altera, Analog Devices, Intersil, Interpoint, Microsemi, Aeroflex, Peregrine, Syfer, Eurofarad, Texas Instrument, Miteq, Cobham, E2V, MA-COM, Hittite, Mini-Circuits, General Dynamics и др.);

Помимо этого, одним из направлений компании «ЭлектроПласт» является направление «Источники питания». Мы предлагаем Вам помощь Конструкторского отдела:

- Подбор оптимального решения, техническое обоснование при выборе компонента;
- Подбор аналогов;
- Консультации по применению компонента;
- Поставка образцов и прототипов;
- Техническая поддержка проекта;
- Защита от снятия компонента с производства.



Как с нами связаться

Телефон: 8 (812) 309 58 32 (многоканальный)

Факс: 8 (812) 320-02-42

Электронная почта: org@eplast1.ru

Адрес: 198099, г. Санкт-Петербург, ул. Калинина, дом 2, корпус 4, литера А.