

EAO – Your Expert Partner for  
Human Machine Interfaces

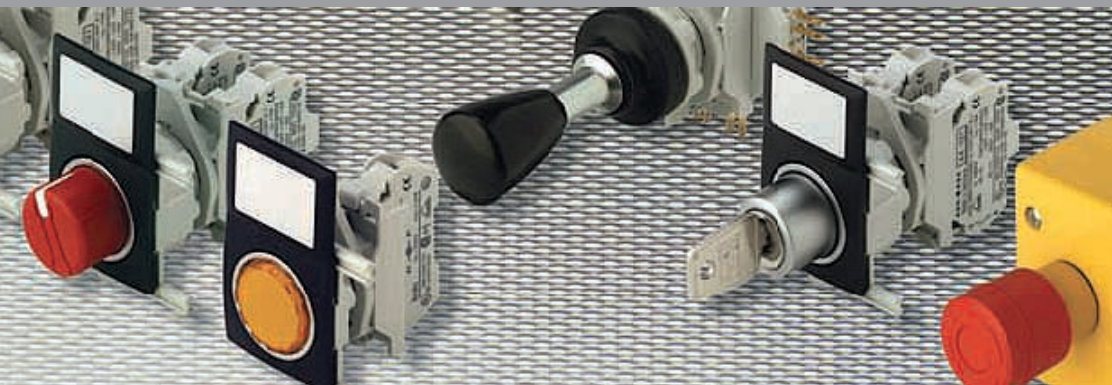

## EAO Product Information

Series 44



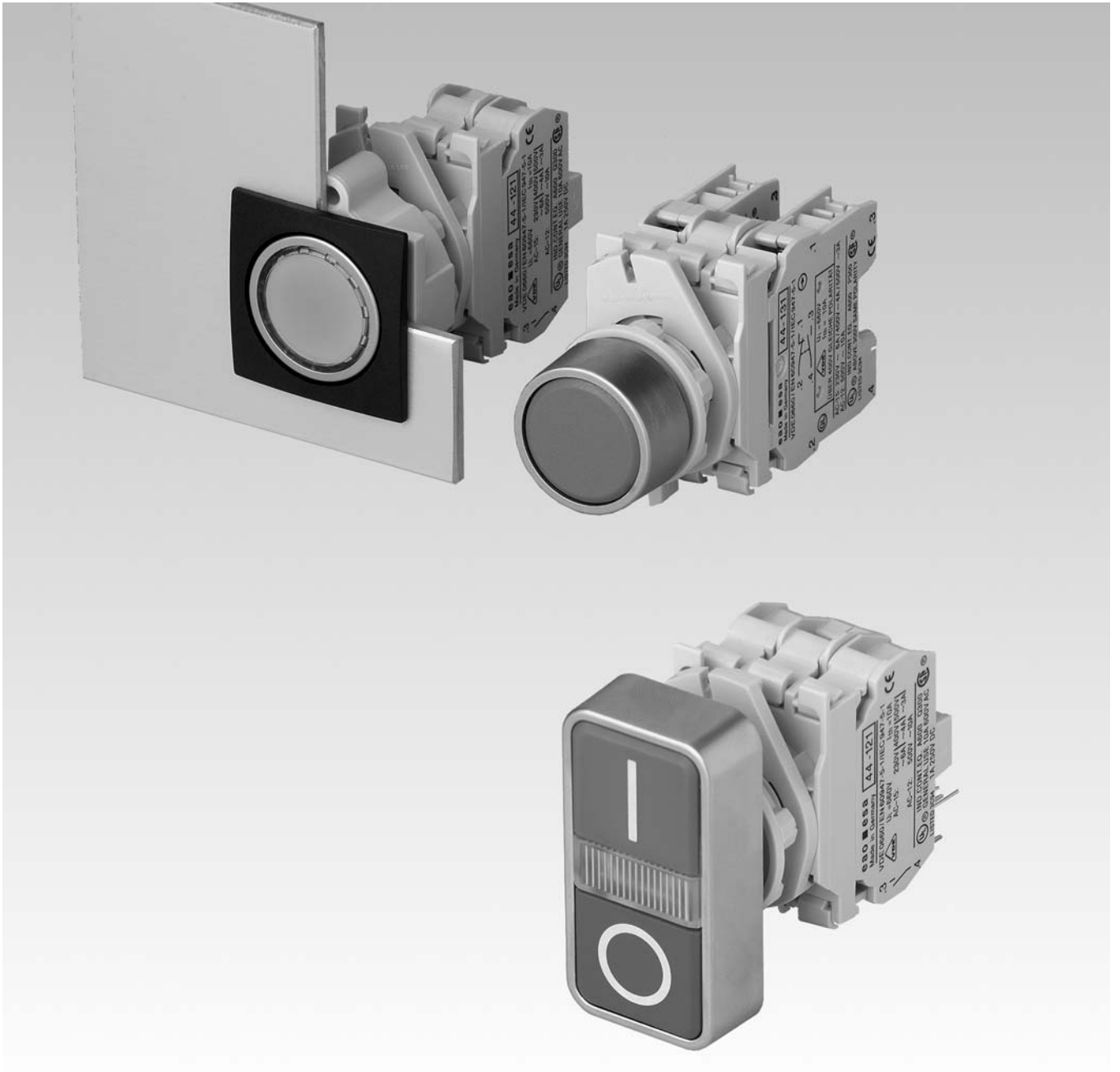

<b>Description .....</b>	<b>3</b>
<b>Product Assembly .....</b>	<b>4</b>
<b>Mounting instruction .....</b>	<b>5</b>
<b>Devices complete, raised mounting.....</b>	<b>6</b>
<b>Devices raised mounting .....</b>	<b>12</b>
<b>Devices flush mounting .....</b>	<b>27</b>
<b>Accessories.....</b>	<b>38</b>
<b>Technical Data.....</b>	<b>50</b>
<b>Typical Applications .....</b>	<b>52</b>
<b>Application guidelines.....</b>	<b>53</b>
<b>Marking .....</b>	<b>54</b>
<b>Drawings.....</b>	<b>57</b>
<b>Index.....</b>	<b>78</b>

## Product Information

### General notes

Series 44, a modular system of control units, offers the user numerous combinations with its wide range of actuator elements for pushbuttons, emergency-stop pushbuttons, rotary and keylock switches, interlocking pushbuttons, potentiometer drives, illuminated pushbuttons and indicators.

At the front the actuators feature an IP 65 protection class and can be supplied with mat grey or mat chrome front rings.

The switching elements can be supplied for fitting on front adaptors or for fitting on base adaptors, so that each control or indication point can be made to fit the requirements of the most varied conditions of usage, such as in industrial and mechanical engineering, marine and rail-vehicle construction, systems engineering and the construction of control mechanisms.

Series 44 is a high-quality product that has been manufactured and tested according to the most up-to-date international regulation and standards. Our products are marked with the CE sign in accordance with the directive for low voltages.

### Design

The system consists of actuators, front or base adaptors, switching elements and lamp elements, pre-switching elements and lamp transformers. The connection between the actuator elements and the various function elements is done by means of a latch click-stop connection through the front adaptor for front attachment.

For base attachment the various function elements are click-stopped on to the base adaptor.

For pushbuttons with front attachment, further switching elements in the 2nd level can be click-stopped on to the 1st level of switching elements (tandem arrangement).

### Mounting

The control pushbuttons and indicators of Series 44 are designed to be fitted in a mounting hole of 22.5 mm diameter in accordance with IEC 60947-5-1 and VDE 0660. The actuators can be inserted in mounting holes with or without recess for the anti-twisting device and are self-holding with means that they can be fitted quickly and easily in the front panel (one-person fitting).

When the actuator elements are installed in metallic front panels and housings, they should not be incorporated in the protection provision. When installed in insulated housing, the "protection insulation" provision is preserved.

### Terminals

All function elements have shockproof screw terminals (finger safety in accordance with DIN VDE 0106, part 100 and VBG 4) and have openings to guide a screwdriver. When delivered, the screw terminals are open, thus guaranteeing safe and fast installation.

The lamp transformer has screw terminals as primary-terminal and as secondary connection connecting leads with multi-core cable ends.

The designation for terminal connections accords with DIN EN 50013.

### Marking

The marking plate for illuminated pushbuttons, indicators or markable pushbuttons can be provided with pictograms conforming to ISO-R 369 or with lettering.

For further information about engraving, hot stamping and film inserts see part Marking.

### Illumination

Incandescent lamps or Single-Chip LEDs with BA9s lampholder assure perfect illumination of the indicators and illuminated pushbuttons.

Luminosity and wave length scattering caused by the technology used in the LED manufacturing processes may lead to visual differences in our products.

### Keylock switch

Standard lock with integrated cap.

Standard lock number is 9500. Without specifications for the lock number we supply standard number 9500.

For locks with defined lock number, add after the Typ-Nr. (code 01 ... 10). Further lock numbers on request.

Spare keys can be ordered by quoting Typ-Nr. 44-919.xx (please state the lock number).

Two keys are supplied with each keylock switch.

### Specimen order

#### Indicator :

- Indicator actuator, 28 mm dia.	44-750.22
Full-face illumination	
Front ring plastic chrome	
Lens plastic red	

#### Essential accessories :

- Front adapter, front mounting, without marking	44-900
- Lamp element, front mounting, socket BA9s	44-524
- Single-Chip LED BA9s, 6 VDC, red	10-2506.1082

*We reserve the right to modify technical data  
All dimensions in mm*

## Illuminated pushbutton, front mounting, raised mounting

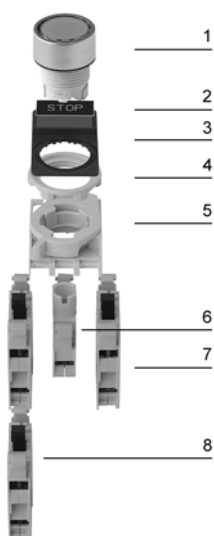

- 1 Actuator
- 2 Label for Label support
- 3 Label support
- 4 Fixing nut
- 5 Front adapter
- 6 Lamp element
- 7 Switching element 1. level
- 8 Switching element 2. level

## Illuminated pushbutton, front mounting, flush mounting

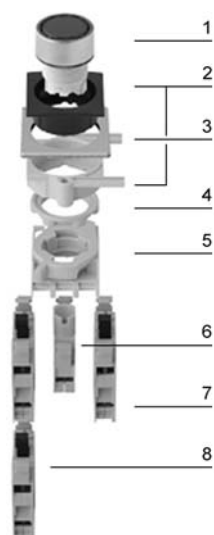

- 1 Actuator
- 2 Front bezel set flush mounting
- 3 Front panel
- 4 Fixing nut
- 5 Front adapter
- 6 Lamp element
- 7 Switching element 1. level
- 8 Switching element 2. level

## Illuminated pushbutton, base mounting (separated mounting), raised mounting

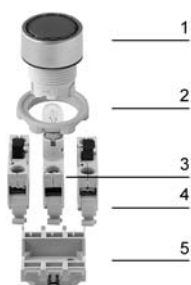

- 1 Actuator
- 2 Fixing nut
- 3 Lamp element
- 4 Switching element
- 5 Base adaptor

## Dismantling function elements

To dismantle switching element, lamp element or lamp transformer, slightly lift the latching arm with the tip of a screwdriver.

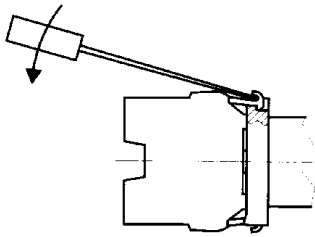

## Mounting lamp transformer

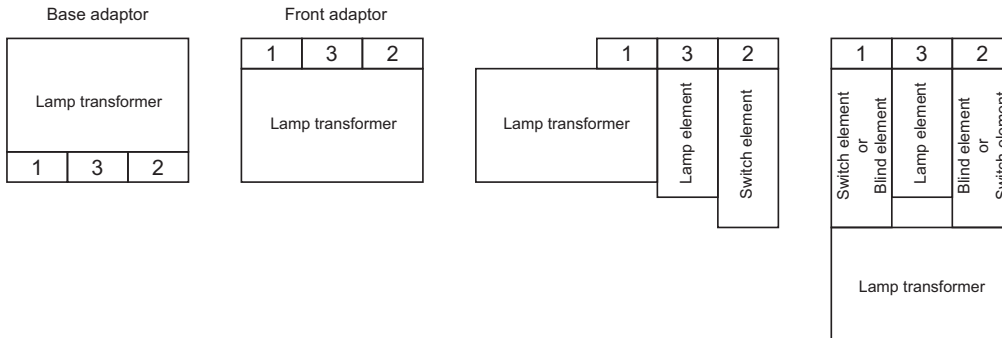

## Enclosure

Mount the actuator so that the anti-twist device faces the square area next to the mounting hole.



Base adaptors are included in the enclosure.

In the ends of the enclosure are cable entries 22.5 mm dia., fitted with an inlet grommet at one end. A second grommet is supplied in the enclosure. In addition, a special screw gland M20 can be supplied Typ-Nr. 44-956.

Openings designations:

A, B, C and D

opening A is nearest to the inlet grommet.

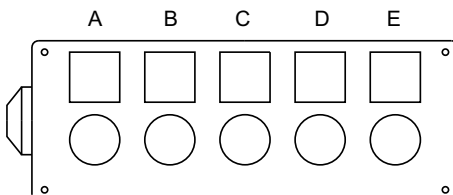

## Indicator full-face illumination complete



### Essential Accessories:

 Single-LED page 45

	Front protection	Terminals	Front ring	Lens cap	Ø 28 mm Typ-Nr.	Mounting dimensions	Technical drawing	Circuit drawing	
<b>Indicator full-face illumination complete</b> non-markable	IP 65	ST	Plastic matt-chrome	Plastic colourless	<b>44-750.27.000</b>	1	13	3	0.025
				Plastic green	<b>44-750.25.000</b>	1	13	3	0.025
				Plastic red	<b>44-750.22.000</b>	1	13	3	0.025
				Plastic yellow	<b>44-750.24.000</b>	1	13	3	0.025

Terminals: ST = Screw terminal

Mounting dimensions from page 58, Technical drawing from page 59, Circuit drawing from page 73

## Indicator front illumination complete



### Essential Accessories:

 Single-LED page 45

	Front protection	Terminals	Front ring	Lens	Ø 28 mm Typ-Nr.	Mounting dimensions	Technical drawing	Circuit drawing	
<b>Indicator front illumination complete</b> markable with text plate translucent white	IP 65	ST	Plastic matt-chrome	Plastic green	<b>44-751.25.000</b>	1	13	3	0.025
				Plastic red	<b>44-751.22.000</b>	1	13	3	0.025
				Plastic white	<b>44-751.29.000</b>	1	13	3	0.025
				Plastic yellow	<b>44-751.24.000</b>	1	13	3	0.025

Terminals: ST = Screw terminal

Mounting dimensions from page 58, Technical drawing from page 59, Circuit drawing from page 73



## Pushbutton complete



	Front protection	Terminals	Switching action	Contacts	Front ring	Lens	Ø 28 mm Typ-Nr.	Mounting dimensions	Technical drawing	Circuit drawing	
<b>Pushbutton complete non-markable</b>	IP 65	ST	MA	1 NC + 1 NO	Plastic matt-chrome	Plastic black	<b>44-702.20.100</b>	1	14	9	0.037
				1 NO	Plastic matt-chrome	Plastic green	<b>44-702.25.010</b>	1	14	7	0.030
			M	1 NC	Plastic matt-chrome	Plastic red	<b>44-701.22.001</b>	1	14	21	0.030
				1 NC + 1 NO	Plastic matt-chrome	Plastic black	<b>44-701.20.100</b>	1	14	25	0.037
				1 NO	Plastic matt-chrome	Plastic green	<b>44-701.25.010</b>	1	14	23	0.030
						Plastic white	<b>44-701.29.010</b>	1	14	23	0.030
						Plastic yellow	<b>44-701.24.010</b>	1	14	23	0.030

Terminals: ST = Screw terminal

Switching action: MA = Maintained action, M = Momentary action

Contacts: NC = Normally closed, NO = Normally open

Mounting dimensions from page 58, Technical drawing from page 59, Circuit drawing from page 73

## Illuminated pushbutton complete



### Essential Accessories:

 Single-LED page 45

	Front protection	Terminals	Switching action	Contacts	Front ring	Lens	Ø 28 mm Typ-Nr.	Mounting dimensions	Technical drawing	Circuit drawing	
<b>Illuminated pushbutton complete markable</b>	IP 65	ST	MA	1 NC + 1 NO	Plastic matt-chrome	Plastic white	<b>44-747.29.100</b>	1	15	10	0.047
				1 NO	Plastic matt-chrome	Plastic green	<b>44-747.25.010</b>	1	15	8	0.040
			M	1 NC	Plastic matt-chrome	Plastic red	<b>44-746.22.001</b>	1	15	22	0.040
				1 NC + 1 NO	Plastic matt-chrome	Plastic white	<b>44-746.29.100</b>	1	15	26	0.047
				1 NO	Plastic matt-chrome	Plastic green	<b>44-746.25.010</b>	1	15	24	0.040
						Plastic yellow	<b>44-746.24.010</b>	1	15	24	0.040

Terminals: ST = Screw terminal

Switching action: MA = Maintained action, M = Momentary action

Contacts: NC = Normally closed, NO = Normally open

Mounting dimensions from page 58, Technical drawing from page 59, Circuit drawing from page 73

## Emergency-stop pushbutton, foolproof EN IEC 60947-5-5, complete

Application as per DIN EN ISO 13850 and EN 60204-1



	Front protection	Terminals	Switching action	Contacts	Mushroom had cap	Ø 37 mm Typ-Nr.	Mounting dimensions	Technical drawing	Circuit drawing	
<b>Emergency-stop pushbutton, foolproof EN IEC 60947-5-5, complete</b> Shaft yellow Key to unlock anti-clockwise Standard lock 9500	IP 65	ST	MA	1 NC	Plastic red	<b>44-713.001</b>	2	29	37	0.083
Shaft yellow Twist to unlock anti-clockwise	IP 65	ST	MA	1 NC	Plastic red	<b>44-712.001</b>	2	29	37	0.047

Terminals: ST = Screw terminal

Switching action: MA = Maintained action

Contacts: NC = Normally closed

Mounting dimensions from page 58, Technical drawing from page 59, Circuit drawing from page 73

## Stop pushbutton, complete



	Front protection	Terminals	Switching action	Contacts	Mushroom had cap	Ø 50 mm Typ-Nr.	Mounting dimensions	Technical drawing	Circuit drawing	
<b>Stop pushbutton, complete</b> Shaft yellow Twist to unlock anti-clockwise	IP 65	ST	MA	1 NC	Plastic red	<b>44-710.001</b>	2	28	37	0.057

Terminals: ST = Screw terminal

Switching action: MA = Maintained action

Contacts: NC = Normally closed

Mounting dimensions from page 58, Technical drawing from page 59, Circuit drawing from page 73

## Key lock switch 2 positions complete

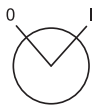

	Front protection	Terminals	Switching action	Contacts	Key remove	Front ring	Ø 28 mm Typ-Nr.	Mounting dimensions	Technical drawing	Circuit drawing	
<b>Key lock switch 2 positions complete</b> Position 0 : Basic position Position I : Maintained action Standard lock 9500	IP 65	ST	MA	1 NC + 1 NO	0	Plastic matt-chrome	<b>44-730.21.100</b>	1	18	33	0.075
					0 + I	Plastic matt-chrome	<b>44-730.22.100</b>	1	18	33	0.075

Terminals: ST = Screw terminal

Switching action: MA = Maintained action

Contacts: NC = Normally closed, NO = Normally open

Mounting dimensions from page 58, Technical drawing from page 59, Circuit drawing from page 73

## Key lock switch 3 positions complete

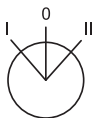

	Front protection	Terminals	Switching action	Contacts	Key remove	Front ring	Ø 28 mm Typ-Nr.	Mounting dimensions	Technical drawing	Circuit drawing	
<b>Key lock switch 3 positions complete</b> Position 0 : Basic position Position I + II : Maintained action Standard lock 9500	IP 65	ST	MA-0-MA	2 NO	I - 0 - II	Plastic matt-chrome	<b>44-734.25.020</b>	1	27	34	0.078

Terminals: ST = Screw terminal

Switching action: MA = Maintained action

Contacts: NO = Normally open

Mounting dimensions from page 58, Technical drawing from page 59, Circuit drawing from page 73

## Selector switch 2 positions complete

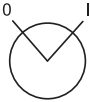

	Front protection	Terminals	Switching action	Contacts	Lever	Front ring	Ø 28 mm Typ-Nr.	Mounting dimensions	Technical drawing	Circuit drawing	
 <p><b>Selector switch 2 positions complete</b> Position 0 : Basic position Position I : Maintained action</p>	IP 65	ST	MA	1 NC + 1 NO	Plastic black	Plastic matt-chrome	<b>44-720.20.100</b>	1	16	17	0.045

Terminals: ST = Screw terminal

Switching action: MA = Maintained action

Contacts: NC = Normally closed, NO = Normally open

Mounting dimensions from page 58, Technical drawing from page 59, Circuit drawing from page 73

## Selector switch 3 positions complete

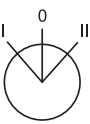

	Front protection	Terminals	Switching action	Contacts	Lever	Front ring	Ø 28 mm Typ-Nr.	Mounting dimensions	Technical drawing	Circuit drawing	
 <p><b>Selector switch 3 positions complete</b> Position 0 : Basic position Position I + II : Maintained action</p>	IP 65	ST	MA-0-MA	2 NO	Plastic black	Plastic matt-chrome	<b>44-724.20.020</b>	1	17	18	0.048

Terminals: ST = Screw terminal

Switching action: MA = Maintained action

Contacts: NO = Normally open

Mounting dimensions from page 58, Technical drawing from page 59, Circuit drawing from page 73

## Control switch



	Front protection	Terminals	Switching action	Contacts	Lever	Ø 22 mm Typ-Nr.	Component layout	Mounting dimensions	Technical drawing	Circuit drawing	
<b>Control switch</b> 2 positions without latch position	IP 65	S1	M	2 NC + 2 NO	Plastic black	<b>44-800.2</b>	1	4	10	40	0.080
4 positions without latch position	IP 65	S1	M	4 NC + 4 NO	Plastic black	<b>44-800.4</b>	2	4	10	41	0.085
8 positions without latch position and lever guidance (omni directional)	IP 65	S1	M	4 NC + 4 NO	Plastic black	<b>44-800.8</b>	2	4	10	42	0.085

### Caution!

With flat receptacle, VDE 0630 and SEV standards specify use of insulating sleeve No. 280-0010-00.

Terminals: S1 = Soldering terminal (also pluggable 2.8 x 0.5 mm)

Switching action: M = Momentary action



Contacts: NC = Normally closed, NO = Normally open

Component layout from page 57, Mounting dimensions from page 58, Technical drawing from page 59, Circuit drawing from page 73

## Indicator actuator full-face illumination



### Essential Accessories:

-  Front adapter, front mounting page 42
-  Lamp element, front mounting page 43
-  Single-LED page 45





	Front protection	Front ring	Lens	Ø 28 mm Typ-Nr.	Mounting dimensions	Technical drawing	
<b>Indicator actuator full-face illumination</b> non-markable	IP 65	Plastic matt-chrome	Plastic blue	<b>44-750.26</b>	1	19	0.008
			Plastic colourless	<b>44-750.27</b>	1	19	0.008
			Plastic green	<b>44-750.25</b>	1	19	0.008
			Plastic red	<b>44-750.22</b>	1	19	0.008
			Plastic yellow	<b>44-750.24</b>	1	19	0.008
			Plastic matt-grey	Plastic blue	<b>44-750.66</b>	1	19
		Plastic colourless	<b>44-750.67</b>	1	19	0.008	
		Plastic green	<b>44-750.65</b>	1	19	0.008	
		Plastic red	<b>44-750.62</b>	1	19	0.008	
		Plastic yellow	<b>44-750.64</b>	1	19	0.008	

Mounting dimensions from page 58, Technical drawing from page 59

## Indicator actuator front illumination



### Essential Accessories:

-  Base adaptor page 43
-  Front adapter, front mounting page 42
-  Lamp element, front mounting page 43
-  Single-LED page 45



	Front protection	Front ring	Lens	Ø 28 mm Typ-Nr.	Mounting dimensions	Technical drawing	
<b>Indicator actuator front illumination</b> markable with text plate translucent white	IP 65	Plastic matt-chrome	Plastic blue	<b>44-751.26</b>	1	22	0.007
			Plastic green	<b>44-751.25</b>	1	22	0.007
			Plastic red	<b>44-751.22</b>	1	22	0.007
			Plastic white	<b>44-751.29</b>	1	22	0.007
			Plastic yellow	<b>44-751.24</b>	1	22	0.007
		Plastic matt-grey	Plastic blue	<b>44-751.66</b>	1	22	0.007
			Plastic green	<b>44-751.65</b>	1	22	0.007
			Plastic red	<b>44-751.62</b>	1	22	0.007
			Plastic white	<b>44-751.69</b>	1	22	0.007
			Plastic yellow	<b>44-751.64</b>	1	22	0.007

Mounting dimensions from page 58, Technical drawing from page 59

## Pushbutton actuator



### Essential Accessories:

-  Base adaptor page 43
-  Front adapter, front mounting page 42
-  Slow-make switching element stackable, front mounting page 42

	Front protection	Switching action	Lens mounting type	Front ring	Lens	Ø 28 mm Typ-Nr.	Mounting dimensions	Technical drawing	Circuit drawing	
<b>Pushbutton actuator</b> non-markable	IP 65	M	level with bezel	Plastic matt-chrome	Plastic black	<b>44-701.20</b>	1	20	2	0.013
					Plastic blue	<b>44-701.26</b>	1	20	2	0.013
					Plastic green	<b>44-701.25</b>	1	20	2	0.013
					Plastic red	<b>44-701.22</b>	1	20	2	0.013
					Plastic white	<b>44-701.29</b>	1	20	2	0.013
					Plastic yellow	<b>44-701.24</b>	1	20	2	0.013
				Plastic matt-grey	Plastic black	<b>44-701.60</b>	1	20	2	0.013
					Plastic blue	<b>44-701.66</b>	1	20	2	0.013
					Plastic green	<b>44-701.65</b>	1	20	2	0.013
					Plastic red	<b>44-701.62</b>	1	20	2	0.013
					Plastic white	<b>44-701.69</b>	1	20	2	0.013
					Plastic yellow	<b>44-701.64</b>	1	20	2	0.013
			lower than bezel	Plastic matt-chrome	Plastic black	<b>44-704.20</b>	1	20	2	0.015
					Plastic blue	<b>44-704.26</b>	1	20	2	0.015
					Plastic green	<b>44-704.25</b>	1	20	2	0.015
					Plastic red	<b>44-704.22</b>	1	20	2	0.015
					Plastic white	<b>44-704.29</b>	1	20	2	0.015
					Plastic yellow	<b>44-704.24</b>	1	20	2	0.015
				Plastic matt-grey	Plastic black	<b>44-704.60</b>	1	20	2	0.015
					Plastic blue	<b>44-704.66</b>	1	20	2	0.015
					Plastic green	<b>44-704.65</b>	1	20	2	0.015
					Plastic red	<b>44-704.62</b>	1	20	2	0.015
					Plastic white	<b>44-704.69</b>	1	20	2	0.015
					Plastic yellow	<b>44-704.64</b>	1	20	2	0.015
			raised above bezel	Plastic matt-chrome	Plastic black	<b>44-703.20</b>	1	20	2	0.015
					Plastic blue	<b>44-703.26</b>	1	20	2	0.015
					Plastic green	<b>44-703.25</b>	1	20	2	0.015
					Plastic red	<b>44-703.22</b>	1	20	2	0.015
					Plastic white	<b>44-703.29</b>	1	20	2	0.015
					Plastic yellow	<b>44-703.24</b>	1	20	2	0.015
				Plastic matt-grey	Plastic black	<b>44-703.60</b>	1	20	2	0.015
					Plastic blue	<b>44-703.66</b>	1	20	2	0.015
					Plastic green	<b>44-703.65</b>	1	20	2	0.015
					Plastic red	<b>44-703.62</b>	1	20	2	0.015
					Plastic white	<b>44-703.69</b>	1	20	2	0.015
					Plastic yellow	<b>44-703.64</b>	1	20	2	0.015

Continuation see next page



Continued from previous page

	Front protection	Switching action	Lens mounting type	Front ring	Lens	Ø 28 mm Typ-Nr.	Mounting dimensions	Technical drawing	Circuit drawing	
non-markable up to 3 Switching elements max.	IP 65	MA	level with bezel	Plastic matt-chrome	Plastic black	<b>44-702.20</b>	1	20	1	0.013
					Plastic blue	<b>44-702.26</b>	1	20	1	0.013
					Plastic green	<b>44-702.25</b>	1	20	1	0.013
					Plastic red	<b>44-702.22</b>	1	20	1	0.013
					Plastic white	<b>44-702.29</b>	1	20	1	0.013
					Plastic yellow	<b>44-702.24</b>	1	20	1	0.013
				Plastic matt-grey	Plastic black	<b>44-702.60</b>	1	20	1	0.013
					Plastic blue	<b>44-702.66</b>	1	20	1	0.013
					Plastic green	<b>44-702.65</b>	1	20	1	0.013
					Plastic red	<b>44-702.62</b>	1	20	1	0.013
					Plastic white	<b>44-702.69</b>	1	20	1	0.013
					Plastic yellow	<b>44-702.64</b>	1	20	1	0.013
			lower than bezel	Plastic matt-chrome	Plastic black	<b>44-706.20</b>	1	20	1	0.015
					Plastic blue	<b>44-706.26</b>	1	20	1	0.015
					Plastic green	<b>44-706.25</b>	1	20	1	0.015
					Plastic red	<b>44-706.22</b>	1	20	1	0.015
					Plastic white	<b>44-706.29</b>	1	20	1	0.015
					Plastic yellow	<b>44-706.24</b>	1	20	1	0.015
				Plastic matt-grey	Plastic black	<b>44-706.60</b>	1	20	1	0.015
					Plastic blue	<b>44-706.66</b>	1	20	1	0.015
					Plastic green	<b>44-706.65</b>	1	20	1	0.015
					Plastic red	<b>44-706.62</b>	1	20	1	0.015
					Plastic white	<b>44-706.69</b>	1	20	1	0.015
					Plastic yellow	<b>44-706.64</b>	1	20	1	0.015
			raised above bezel	Plastic matt-chrome	Plastic black	<b>44-705.20</b>	1	20	1	0.015
					Plastic blue	<b>44-705.26</b>	1	20	1	0.015
					Plastic green	<b>44-705.25</b>	1	20	1	0.015
					Plastic red	<b>44-705.22</b>	1	20	1	0.015
					Plastic white	<b>44-705.29</b>	1	20	1	0.015
					Plastic yellow	<b>44-705.24</b>	1	20	1	0.015
				Plastic matt-grey	Plastic black	<b>44-705.60</b>	1	20	1	0.015
					Plastic blue	<b>44-705.66</b>	1	20	1	0.015
					Plastic green	<b>44-705.65</b>	1	20	1	0.015
					Plastic red	<b>44-705.62</b>	1	20	1	0.015
					Plastic white	<b>44-705.69</b>	1	20	1	0.015
					Plastic yellow	<b>44-705.64</b>	1	20	1	0.015



Switching action: M = Momentary action, MA = Maintained action

Mounting dimensions from page 58, Technical drawing from page 59, Circuit drawing from page 73

## Pushbutton actuator markable



### Essential Accessories:

-  Front adapter, front mounting page 42
-  Marking plate for Lens page 38
-  Slow-make switching element stackable, front mounting page 42

	Front protection	Switching action	Lens	Front ring	Ø 28 mm Typ-Nr.	Mounting dimensions	Technical drawing	Circuit drawing	
<b>Pushbutton actuator markable</b> Colour of lens is determined by the colour of text plate	IP 65	M	Plastic colourless	Plastic matt-chrome	<b>44-701.27</b>	1	23	2	0.012
				Plastic matt-grey	<b>44-701.67</b>	1	23	2	0.012
Colour of lens is determined by the colour of text plate, up to 3 Switching elements max.	IP 65	MA	Plastic colourless	Plastic matt-chrome	<b>44-702.27</b>	1	23	1	0.012
				Plastic matt-grey	<b>44-702.67</b>	1	23	1	0.012





Switching action: M = Momentary action, MA = Maintained action

Mounting dimensions from page 58, Technical drawing from page 59, Circuit drawing from page 73

## Illuminated pushbutton actuator



### Essential Accessories:

-  Front adapter, front mounting page 42
-  Lamp element, front mounting page 43
-  Single-LED page 45
-  Slow-make switching element stackable, front mounting page 42

	Front protection	Switching action	Front ring	Lens	Ø 28 mm Typ-Nr.	Mounting dimensions	Technical drawing	Circuit drawing	
<b>Illuminated pushbutton actuator</b> markable with text plate translucent white	IP 65	M	Plastic matt-chrome	Plastic blue	<b>44-746.26</b>	1	24	20	0.012
				Plastic green	<b>44-746.25</b>	1	24	20	0.012
				Plastic red	<b>44-746.22</b>	1	24	20	0.012
				Plastic white	<b>44-746.29</b>	1	24	20	0.012
				Plastic yellow	<b>44-746.24</b>	1	24	20	0.012
			Plastic matt-grey	Plastic blue	<b>44-746.66</b>	1	24	20	0.012
				Plastic green	<b>44-746.65</b>	1	24	20	0.012
				Plastic red	<b>44-746.62</b>	1	24	20	0.012
				Plastic white	<b>44-746.69</b>	1	24	20	0.012
				Plastic yellow	<b>44-746.64</b>	1	24	20	0.012
markable with text plate translucent white, up to max. 3 switching elements	IP 65	MA	Plastic matt-chrome	Plastic blue	<b>44-747.26</b>	1	24	6	0.012
				Plastic green	<b>44-747.25</b>	1	24	6	0.012
				Plastic red	<b>44-747.22</b>	1	24	6	0.012
				Plastic white	<b>44-747.29</b>	1	24	6	0.012
				Plastic yellow	<b>44-747.24</b>	1	24	6	0.012
			Plastic matt-grey	Plastic blue	<b>44-747.66</b>	1	24	6	0.012
				Plastic green	<b>44-747.65</b>	1	24	6	0.012
				Plastic red	<b>44-747.62</b>	1	24	6	0.012
				Plastic white	<b>44-747.69</b>	1	24	6	0.012
				Plastic yellow	<b>44-747.64</b>	1	24	6	0.012





Switching action: M = Momentary action, MA = Maintained action

Mounting dimensions from page 58, Technical drawing from page 59, Circuit drawing from page 73

## Double pushbutton actuator



### Essential Accessories:

-  Front adapter, front mounting page 42
-  Lamp element, front mounting page 43
-  Single-LED page 45
-  Slow-make switching element stackable, front mounting page 42

	Front protection	Switching action	Front bezel	Lens	Marking	Typ-Nr.	Component layout Mounting dimensions			Technical drawing
<b>Double pushbutton actuator</b> with illuminative centre window	IP 65	M	Plastic matt-chrome	Plastic green-red	I - 0	<b>44-771.2</b>	3	3	36	0.018
					without	<b>44-770.2</b>	3	3	36	0.018
				Plastic white-black	I - 0	<b>44-774.2</b>	3	3	36	0.018
					without	<b>44-773.2</b>	3	3	36	0.018
			Plastic matt-grey	Plastic green-red	I - 0	<b>44-771.6</b>	3	3	36	0.018
					without	<b>44-770.6</b>	3	3	36	0.018
				Plastic white-black	I - 0	<b>44-774.6</b>	3	3	36	0.018
					without	<b>44-773.6</b>	3	3	36	0.018

Switching action: M = Momentary action



Component layout from page 57, Mounting dimensions from page 58, Technical drawing from page 59

## Emergency-stop pushbutton actuator, foolproof EN IEC 60947-5-5

Application as per DIN EN ISO 13850 and EN 60204-1



### Essential Accessories:

-  Front adapter, front mounting page 42
-  Slow-make switching element stackable, front mounting page 42

	Front protection	Switching action	Mushroom had cap	Ø 37 mm Typ-Nr.	Mounting dimensions	Technical drawing	Circuit drawing	
<b>Emergency-stop pushbutton actuator, foolproof EN IEC 60947-5-5</b> Foolproof, Shaft yellow Key to unlock anti-clockwise Standard lock 9500 up to 3 Switching elements max. in 1st level	IP 65	MA	Plastic red	<b>44-713</b>	2	32	5	0.066
Yellow shaft Twist to unlock anti-clockwise up to 3 Switching elements max. in 1st level	IP 65	MA	Plastic red	<b>44-712</b>	2	32	5	0.040

Other lock numbers on request

Switching action: MA = Maintained action

Mounting dimensions from page 58, Technical drawing from page 59, Circuit drawing from page 73

## Emergency-stop enclosure



	Protection degree	Terminals	Switching action	Contacts	Mushroom had cap	Ø 37 mm Typ-Nr.	Technical drawing	
<b>Emergency-stop enclosure</b> with 1 Emergency-stop pushbutton, foolproof, twist to unlock. Enclosure 72 x 84 mm, yellow	IP 65	ST	MA	1 NC + 1 NO	Plastic red	<b>44-001.4-05</b>	44	0.234

Terminals: ST = Screw terminal

Switching action: MA = Maintained action



Contacts: NC = Normally closed, NO = Normally open

Technical drawing from page 59

## Stop pushbutton actuator



### Essential Accessories:

-  Front adapter, front mounting page 42
-  Slow-make switching element non-stackable, base mounting page 43
-  Slow-make switching element stackable, front mounting page 42

	Front protection	Switching action		Ø 50 mm Typ-Nr.	Ø 37 mm Typ-Nr.	Mounting dimensions	Technical drawing	Circuit drawing	
<b>Stop pushbutton actuator</b> Yellow shaft Twist to unlock anti-clockwise up to 3 Switching elements max. in 1st level	IP 65	MA	Mushroom had cap Plastic red	<b>44-710</b>		2	33	5	0.040
					<b>44-711</b>	2	33	5	0.035

Switching action: MA = Maintained action

Mounting dimensions from page 58, Technical drawing from page 59, Circuit drawing from page 73

## Stop pushbutton enclosure



	Protection degree	Terminals	Switching action	Contacts	Mushroom had cap	Lens	Ø 50 mm Typ-Nr.	Technical drawing	
<b>Stop pushbutton enclosure</b> with 1 Stop pushbutton, twist to unlock. Enclosure 72 x 84 mm, yellow	IP 65	ST	MA	1 NC + 1 NO	Plastic	red	<b>44-001.4-03</b>	44	0.234

Terminals: ST = Screw terminal

Switching action: MA = Maintained action



Contacts: NC = Normally closed, NO = Normally open

Technical drawing from page 59

## Mushroom-head pushbutton actuator



### Essential Accessories:

-  Front adapter, front mounting page 42
-  Slow-make switching element stackable, front mounting page 42

	Front protection	Switching action	Front ring	Mushroom had cap	Ø 50 mm Typ-Nr.	Mounting dimensions	Technical drawing	Circuit drawing	
<b>Mushroom-head pushbutton actuator</b>	IP 65	M	Plastic matt-chrome	Plastic black	<b>44-707.20</b>	2	31	2	0.028
				Plastic green	<b>44-707.25</b>	2	31	2	0.028
				Plastic red	<b>44-707.22</b>	2	31	2	0.028
			Plastic matt-grey	Plastic black	<b>44-707.60</b>	2	31	2	0.028
				Plastic green	<b>44-707.65</b>	2	31	2	0.028
				Plastic red	<b>44-707.62</b>	2	31	2	0.028



Switching action: M = Momentary action

Mounting dimensions from page 58, Technical drawing from page 59, Circuit drawing from page 73

## Keylock switch actuator 2 positions



### Essential Accessories:

-  Front adapter, front mounting page 42
-  Slow-make switching element stackable, front mounting page 42

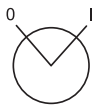

	Front protection	Switching action	Key remove	Front ring	Ø 28 mm Typ-Nr.	Component layout	Mounting dimensions	Technical drawing	Circuit drawing	
<b>Keylock switch actuator 2 positions</b> Position 0 : Basic position Position I : Maintained action 90° Standard lock 9500 up to 3 Switching elements max. in 1st level	IP 65	MA	0	Plastic matt-chrome	<b>44-730.21</b>	4	1	30	30	0.051
				Plastic matt-grey	<b>44-730.61</b>	4	1	30	30	0.051
			0 + I	Plastic matt-chrome	<b>44-730.22</b>	4	1	30	30	0.051
				Plastic matt-grey	<b>44-730.62</b>	4	1	30	30	0.051
Position 0 : Basic position Position I : Momentary action 90° Standard lock 9500 up to 3 Switching elements max. in 1st level	IP 65	M	0	Plastic matt-chrome	<b>44-732.21</b>	4	1	30	27	0.051
				Plastic matt-grey	<b>44-732.61</b>	4	1	30	27	0.051

Other lock numbers on request



Switching action: MA = Maintained action, M = Momentary action

Component layout from page 57, Mounting dimensions from page 58, Technical drawing from page 59, Circuit drawing from page 73

## Keylock switch actuator 3 positions



### Essential Accessories:

-  Front adapter, front mounting page 42
-  Slow-make switching element stackable, front mounting page 42

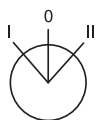

	Front protection	Switching action	Key remove	Front ring	Ø 28 mm Typ-Nr.	Component layout	Mounting dimensions	Technical drawing	Circuit drawing	
<b>Keylock switch actuator 3 positions</b> Position 0 : Basic position Position I : Maintained action 60° Position II : Momentary action 60° Standard lock 9500 up to 3 Switching elements max. in 1st level	IP 65	MA-0-M	0	Plastic matt-chrome	<b>44-736.21</b>	5	1	30	31	0.051
				Plastic matt-grey	<b>44-736.61</b>	5	1	30	31	0.051
			I + 0	Plastic matt-chrome	<b>44-736.23</b>	5	1	30	31	0.051
				Plastic matt-grey	<b>44-736.63</b>	5	1	30	31	0.051
Position 0 : Basic position Position I : Momentary action 60° Position II : Maintained action 60° Standard lock 9500 up to 3 Switching elements in 1st level	IP 65	M-0-MA	0	Plastic matt-chrome	<b>44-737.21</b>	5	1	30	29	0.051
				Plastic matt-grey	<b>44-737.61</b>	5	1	30	29	0.051
			0 + II	Plastic matt-chrome	<b>44-737.24</b>	5	1	30	29	0.051
				Plastic matt-grey	<b>44-737.64</b>	5	1	30	29	0.051
Position 0 : Basic position Position I + II : Maintained action 60° Standard lock 9500 up to 3 Switching elements in 1st level	IP 65	MA-0-MA	0	Plastic matt-chrome	<b>44-734.21</b>	5	1	30	32	0.051
				Plastic matt-grey	<b>44-734.61</b>	5	1	30	32	0.051
			0 + II	Plastic matt-chrome	<b>44-734.24</b>	5	1	30	32	0.051
				Plastic matt-grey	<b>44-734.64</b>	5	1	30	32	0.051
			I + 0	Plastic matt-chrome	<b>44-734.23</b>	5	1	30	32	0.051
				Plastic matt-grey	<b>44-734.63</b>	5	1	30	32	0.051
			I + 0 + II	Plastic matt-chrome	<b>44-734.25</b>	5	1	30	32	0.051
				Plastic matt-grey	<b>44-734.65</b>	5	1	30	32	0.051
Position 0 : Basic position Position I + II : Momentary action 60° Standard lock 9500 up to 3 Switching elements max. in 1st level	IP 65	M-0-M	0	Plastic matt-chrome	<b>44-735.21</b>	5	1	30	28	0.051
				Plastic matt-grey	<b>44-735.61</b>	5	1	30	28	0.051

Other lock numbers on request

Switching action: MA = Maintained action, M = Momentary action



Component layout from page 57, Mounting dimensions from page 58, Technical drawing from page 59, Circuit drawing from page 73





## Selector switch actuator 2 positions

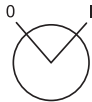

### Essential Accessories:

-  Front adapter, front mounting page 42
-  Slow-make switching element stackable, front mounting page 42



	Front protection	Switching action	Lever	Front ring	Ø 28 mm Typ-Nr.	Component layout	Mounting dimensions	Technical drawing	Circuit drawing	
<b>Selector switch actuator 2 positions</b> Position 0 : Basic position Position I : Maintained action 90° up to 3 Switching elements max. in 1st level	IP 65	MA	Plastic black	Plastic matt-chrome	<b>44-720.20</b>	4	1	21	14	0.021
			Plastic grey	Plastic matt-grey	<b>44-720.68</b>	4	1	21	14	0.021
			Plastic red	Plastic matt-chrome	<b>44-720.22</b>	4	1	21	14	0.021
				Plastic matt-grey	<b>44-720.62</b>	4	1	21	14	0.021
Position 0 : Basic position Position I : Momentary action 90° up to 3 Switching elements in 1st level	IP 65	M	Plastic black	Plastic matt-chrome	<b>44-722.20</b>	4	1	21	11	0.021
			Plastic grey	Plastic matt-grey	<b>44-722.68</b>	4	1	21	11	0.021

Switching action: MA = Maintained action, M = Momentary action

Component layout from page 57, Mounting dimensions from page 58, Technical drawing from page 59, Circuit drawing from page 73

## Selector switch actuator 3 positions



### Essential Accessories:

- Front adapter, front mounting page 42
- Slow-make switching element stackable, front mounting page 42

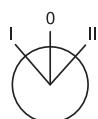

	Front protection	Switching action	Lever	Front ring	Ø 28 mm Typ-Nr.	Component layout	Mounting dimensions	Technical drawing	Circuit drawing	
<b>Selector switch actuator 3 positions</b> Position 0 : Basic position position I : Maintained action 60° Position II : Momentary action 60° up to 3 Switching elements max. in 1st level	IP 65	MA-0-M	Plastic black	Plastic matt-chrome	<b>44-726.20</b>	5	1	21	15	0.021
			Plastic grey	Plastic matt-grey	<b>44-726.68</b>	5	1	21	15	0.021
Position 0 : Basic position Position I : Momentary action 60° Position II : Maintained action 60° up to 3 Switching elements max. in 1st level	IP 65	M-0-MA	Plastic black	Plastic matt-chrome	<b>44-727.20</b>	5	1	21	13	0.021
			Plastic grey	Plastic matt-grey	<b>44-727.68</b>	5	1	21	13	0.021
Position 0 : Basic position Position I + II : Maintained action 60° up to 3 Switching elements max. in 1st level	IP 65	MA-0-MA	Plastic black	Plastic matt-chrome	<b>44-724.20</b>	5	1	21	16	0.021
			Plastic grey	Plastic matt-grey	<b>44-724.68</b>	5	1	21	16	0.021
Position 0 : Basic position Position I + II : Momentary action 60° up to 3 Switching elements max. in 1st level	IP 65	M-0-M	Plastic black	Plastic matt-chrome	<b>44-725.20</b>	5	1	21	12	0.021
			Plastic grey	Plastic matt-grey	<b>44-725.68</b>	5	1	21	12	0.021



Switching action: MA = Maintained action, M = Momentary action

Component layout from page 57, Mounting dimensions from page 58, Technical drawing from page 59, Circuit drawing from page 73

## Interlocking pushbutton actuator



### Essential Accessories:

-  Front adapter, front mounting page 42
-  Slow-make switching element non-stackable, base mounting page 43
-  Slow-make switching element stackable, front mounting page 42

	Front protection	Front ring	Rotating knob	Ø 28 mm Typ-Nr.	Mounting dimensions	Technical drawing	Circuit drawing	
<b>Interlocking pushbutton actuator</b> in activated state locked by turning to the right, otherwise Momentary action up to 3 Switching elements max. in 1st level	IP 65	Plastic matt-chrome	Plastic black	<b>44-742.20</b>	1	35	19	0.020
			Plastic red	<b>44-742.22</b>	1	35	19	0.020
		Plastic matt-grey	Plastic grey	<b>44-742.68</b>	1	35	19	0.020
			Plastic red	<b>44-742.62</b>	1	35	19	0.020

Mounting dimensions from page 58, Technical drawing from page 59, Circuit drawing from page 73

## Pushbutton enclosure



	Front protection	Terminals	Switching action	Front ring	Contacts	Lens	Marking	Ø 28 mm Typ-Nr.	Technical drawing	
<b>Pushbutton enclosure</b> with 1 Pushbutton. Enclosure 72 x 84 mm, light-grey	IP 65	ST	M	Plastic matt-grey	1 NC + 1 NO	Plastic green	I	<b>44-001.8-01</b>	44	0.205
						Plastic red	0	<b>44-001.8-02</b>	44	0.206
<b>Pushbutton enclosure</b> with 2 Pushbuttons. Enclosure 72 x 117 mm, light-grey	IP 65	ST	M	Plastic matt-grey	2 NC + 2 NO	Plastic green-red	green: I, red: 0	<b>44-002.8-04</b>	44	0.247

Terminals: ST = Screw terminal

Switching action: M = Momentary action

Contacts: NC = Normally closed, NO = Normally open

Technical drawing from page 59

## Potentiometer-drive



	Front protection	Front ring	Ø 28 mm Typ-Nr.	Mounting dimensions	Technical drawing	Circuit drawing	
<b>Potentiometer-drive</b> Potentiometer 10 kΩ included others on request, resistance value as per IEC 63, series E3	IP 65	Plastic matt-chrome	<b>44-745.20-10K1</b>	1	37	4	0.030
		Plastic matt-grey	<b>44-745.60-10K1</b>	1	37	4	0.030
without Potentiometer Specification for Potentiometer : Shaft = length 32 mm Shaft end = Form A Diameter = 6 mm	IP 65	Plastic matt-chrome	<b>44-744.20</b>	1	37		0.016
		Plastic matt-grey	<b>44-744.60</b>	1	37		0.016

Mounting dimensions from page 58, Technical drawing from page 59, Circuit drawing from page 73

## Indicator actuator full face illumination, flush mounting



### Essential Accessories:

- 🛒 Front adapter, front mounting page 42
- 🛒 Front bezel set without label support, flush mounting page 38
- 🛒 Lamp element, front mounting page 43
- 🛒 Single-LED page 45





	Front protection	Front ring	Lens	Typ-Nr.	Mounting dimensions		Technical drawing
<b>Indicator actuator full face illumination, flush mounting non-markable</b>	IP 65	Plastic matt-chrome	Plastic blue	<b>44-750.26</b>	5	12	0.008
			Plastic colourless	<b>44-750.27</b>	5	12	0.008
			Plastic green	<b>44-750.25</b>	5	12	0.008
			Plastic red	<b>44-750.22</b>	5	12	0.008
			Plastic yellow	<b>44-750.24</b>	5	12	0.008
		Plastic matt-grey	Plastic blue	<b>44-750.66</b>	5	12	0.008
			Plastic colourless	<b>44-750.67</b>	5	12	0.008
			Plastic green	<b>44-750.65</b>	5	12	0.008
			Plastic red	<b>44-750.62</b>	5	12	0.008
			Plastic yellow	<b>44-750.64</b>	5	12	0.008

Mounting dimensions from page 58, Technical drawing from page 59

## Indicator actuator front illumination, flush mounting



### Essential Accessories:

-  Front adapter, front mounting page 42
-  Front bezel set without label support, flush mounting page 38
-  Lamp element, front mounting page 43
-  Single-LED page 45



	Front protection	Front ring	Lens	Typ-Nr.	Mounting dimensions		Technical drawing
<b>Indicator actuator front illumination, flush mounting</b> markable with text plate translucent white	IP 65	Plastic matt-chrome	Plastic blue	<b>44-751.26</b>	5	12	0.007
			Plastic green	<b>44-751.25</b>	5	12	0.007
			Plastic red	<b>44-751.22</b>	5	12	0.007
			Plastic white	<b>44-751.29</b>	5	12	0.007
			Plastic yellow	<b>44-751.24</b>	5	12	0.007
		Plastic matt-grey	Plastic blue	<b>44-751.66</b>	5	12	0.007
			Plastic green	<b>44-751.65</b>	5	12	0.007
			Plastic red	<b>44-751.62</b>	5	12	0.007
			Plastic white	<b>44-751.69</b>	5	12	0.007
			Plastic yellow	<b>44-751.64</b>	5	12	0.007

Mounting dimensions from page 58, Technical drawing from page 59

## Pushbutton actuator, flush mounting



### Essential Accessories:

-  Front adapter, front mounting page 42
-  Front bezel set without label support, flush mounting page 38
-  Slow-make switching element stackable, front mounting page 42

	Front protection	Switching action	Lens Mounting type	Front ring	Lens	Typ-Nr.	Mounting dimensions	Technical drawing	Circuit drawing		
<b>Pushbutton actuator, flush mounting</b> non-markable	IP 65	M	level with bezel	Plastic matt-chrome	Plastic black	<b>44-701.20</b>	5	11	2	0.013	
					Plastic blue	<b>44-701.26</b>	5	11	2	0.013	
					Plastic green	<b>44-701.25</b>	5	11	2	0.013	
					Plastic red	<b>44-701.22</b>	5	11	2	0.013	
					Plastic white	<b>44-701.29</b>	5	11	2	0.013	
					Plastic yellow	<b>44-701.24</b>	5	11	2	0.013	
				Plastic matt-grey	Plastic black	<b>44-701.60</b>	5	11	2	0.013	
					Plastic blue	<b>44-701.66</b>	5	11	2	0.013	
					Plastic green	<b>44-701.65</b>	5	11	2	0.013	
					Plastic red	<b>44-701.62</b>	5	11	2	0.013	
					Plastic white	<b>44-701.69</b>	5	11	2	0.013	
					Plastic yellow	<b>44-701.64</b>	5	11	2	0.013	
				lower than bezel	Plastic matt-chrome	Plastic black	<b>44-704.20</b>	5	11	2	0.015
						Plastic blue	<b>44-704.26</b>	5	11	2	0.015
						Plastic green	<b>44-704.25</b>	5	11	2	0.015
			Plastic red			<b>44-704.22</b>	5	11	2	0.015	
			Plastic white			<b>44-704.29</b>	5	11	2	0.015	
			Plastic yellow			<b>44-704.24</b>	5	11	2	0.015	
			Plastic matt-grey		Plastic black	<b>44-704.60</b>	5	11	2	0.015	
					Plastic blue	<b>44-704.66</b>	5	11	2	0.015	
					Plastic green	<b>44-704.65</b>	5	11	2	0.015	
					Plastic red	<b>44-704.62</b>	5	11	2	0.015	
					Plastic white	<b>44-704.69</b>	5	11	2	0.015	
					Plastic yellow	<b>44-704.64</b>	5	11	2	0.015	
			raised above bezel		Plastic matt-chrome	Plastic black	<b>44-703.20</b>	5	11	2	0.015
						Plastic blue	<b>44-703.26</b>	5	11	2	0.015
						Plastic green	<b>44-703.25</b>	5	11	2	0.015
				Plastic red		<b>44-703.22</b>	5	11	2	0.015	
				Plastic white		<b>44-703.29</b>	5	11	2	0.015	
				Plastic yellow		<b>44-703.24</b>	5	11	2	0.015	
Plastic matt-grey	Plastic black	<b>44-703.60</b>		5	11	2	0.015				
	Plastic blue	<b>44-703.66</b>		5	11	2	0.015				
	Plastic green	<b>44-703.65</b>		5	11	2	0.015				
	Plastic red	<b>44-703.62</b>		5	11	2	0.015				
	Plastic white	<b>44-703.69</b>		5	11	2	0.015				
	Plastic yellow	<b>44-703.64</b>		5	11	2	0.015				

Continuation see next page

Continued from previous page

	Front protection	Switching action	Lens Mounting type	Front ring	Lens	Typ-Nr.	Mounting dimensions	Technical drawing	Circuit drawing	
non-markable up to 3 Switching elements max.	IP 65	MA	level with bezel	Plastic matt-chrome	Plastic black	<b>44-702.20</b>	5	11	1	0.013
					Plastic blue	<b>44-702.26</b>	5	11	1	0.013
					Plastic green	<b>44-702.25</b>	5	11	1	0.013
					Plastic red	<b>44-702.22</b>	5	11	1	0.013
					Plastic white	<b>44-702.29</b>	5	11	1	0.013
					Plastic yellow	<b>44-702.24</b>	5	11	1	0.013
				Plastic matt-grey	Plastic black	<b>44-702.60</b>	5	11	1	0.013
					Plastic blue	<b>44-702.66</b>	5	11	1	0.013
					Plastic green	<b>44-702.65</b>	5	11	1	0.013
					Plastic red	<b>44-702.62</b>	5	11	1	0.013
					Plastic white	<b>44-702.69</b>	5	11	1	0.013
					Plastic yellow	<b>44-702.64</b>	5	11	1	0.013
			lower than bezel	Plastic matt-chrome	Plastic black	<b>44-706.20</b>	5	11	1	0.015
					Plastic blue	<b>44-706.26</b>	5	11	1	0.015
					Plastic green	<b>44-706.25</b>	5	11	1	0.015
					Plastic red	<b>44-706.22</b>	5	11	1	0.015
					Plastic white	<b>44-706.29</b>	5	11	1	0.015
					Plastic yellow	<b>44-706.24</b>	5	11	1	0.015
				Plastic matt-grey	Plastic black	<b>44-706.60</b>	5	11	1	0.015
					Plastic blue	<b>44-706.66</b>	5	11	1	0.015
					Plastic green	<b>44-706.65</b>	5	11	1	0.015
					Plastic red	<b>44-706.62</b>	5	11	1	0.015
					Plastic white	<b>44-706.69</b>	5	11	1	0.015
					Plastic yellow	<b>44-706.64</b>	5	11	1	0.015
			raised above bezel	Plastic matt-chrome	Plastic black	<b>44-705.20</b>	5	11	1	0.015
					Plastic blue	<b>44-705.26</b>	5	11	1	0.015
					Plastic green	<b>44-705.25</b>	5	11	1	0.015
					Plastic red	<b>44-705.22</b>	5	11	1	0.015
					Plastic white	<b>44-705.29</b>	5	11	1	0.015
					Plastic yellow	<b>44-705.24</b>	5	11	1	0.015
				Plastic matt-grey	Plastic black	<b>44-705.60</b>	5	11	1	0.015
					Plastic blue	<b>44-705.66</b>	5	11	1	0.015
					Plastic green	<b>44-705.65</b>	5	11	1	0.015
					Plastic red	<b>44-705.62</b>	5	11	1	0.015
					Plastic white	<b>44-705.69</b>	5	11	1	0.015
					Plastic yellow	<b>44-705.64</b>	5	11	1	0.015

Switching action: M = Momentary action, MA = Maintained action





Mounting dimensions from page 58, Technical drawing from page 59, Circuit drawing from page 73



## Pushbutton actuator markable, flush mounting



### Essential Accessories:

-  Front adapter, front mounting page 42
-  Front bezel set without label support, flush mounting page 38
-  Marking plate for Lens page 38
-  Slow-make switching element stackable, front mounting page 42

	Front protection	Switching action	Lens	Front ring	Typ-Nr.	Mounting dimensions	Technical drawing	Circuit drawing	
<b>Pushbutton actuator markable, flush mounting</b> Colour of lens is determined by the colour of text plate	IP 65	M	Plastic colourless	Plastic matt-chrome	<b>44-701.27</b>	5	25	2	0.012
				Plastic matt-grey	<b>44-701.67</b>	5	25	2	0.012
Colour of lens is determined by the colour of text plate, up to 3 Switching elements max.	IP 65	MA	Plastic colourless	Plastic matt-chrome	<b>44-702.27</b>	5	25	1	0.012
				Plastic matt-grey	<b>44-702.67</b>	5	25	1	0.012





Switching action: M = Momentary action, MA = Maintained action

Mounting dimensions from page 58, Technical drawing from page 59, Circuit drawing from page 73

## Illuminated pushbutton actuator, flush mounting



### Essential Accessories:

-  Front adapter, front mounting page 42
-  Front bezel set without label support, flush mounting page 38
-  Lamp element, front mounting page 43
-  Single-LED page 45
-  Slow-make switching element stackable, front mounting page 42

	Front protection	Switching action	Front ring	Lens	Typ-Nr.	Mounting dimensions	Technical drawing	Circuit drawing	
<b>Illuminated pushbutton actuator, flush mounting</b> markable with text plate translucent white	IP 65	M	Plastic matt-chrome	Plastic blue	<b>44-746.26</b>	5	25	20	0.012
				Plastic green	<b>44-746.25</b>	5	25	20	0.012
				Plastic red	<b>44-746.22</b>	5	25	20	0.012
				Plastic white	<b>44-746.29</b>	5	25	20	0.012
				Plastic yellow	<b>44-746.24</b>	5	25	20	0.012
			Plastic matt-grey	Plastic blue	<b>44-746.66</b>	5	25	20	0.012
				Plastic green	<b>44-746.65</b>	5	25	20	0.012
				Plastic red	<b>44-746.62</b>	5	25	20	0.012
				Plastic white	<b>44-746.69</b>	5	25	20	0.012
				Plastic yellow	<b>44-746.64</b>	5	25	20	0.012
markable with text plate translucent white, up to max. 3 switching elements	IP 65	MA	Plastic matt-chrome	Plastic blue	<b>44-747.26</b>	5	25	6	0.012
				Plastic green	<b>44-747.25</b>	5	25	6	0.012
				Plastic red	<b>44-747.22</b>	5	25	6	0.012
				Plastic white	<b>44-747.29</b>	5	25	6	0.012
				Plastic yellow	<b>44-747.24</b>	5	25	6	0.012
			Plastic matt-grey	Plastic blue	<b>44-747.66</b>	5	25	6	0.012
				Plastic green	<b>44-747.65</b>	5	25	6	0.012
				Plastic red	<b>44-747.62</b>	5	25	6	0.012
				Plastic white	<b>44-747.69</b>	5	25	6	0.012
				Plastic yellow	<b>44-747.64</b>	5	25	6	0.012





Switching action: M = Momentary action, MA = Maintained action

Mounting dimensions from page 58, Technical drawing from page 59, Circuit drawing from page 73

## Keylock switch actuator 2 positions, flush mounting



### Essential Accessories:

-  Base adaptor page 43
-  Front adapter, front mounting page 42
-  Front bezel set without label support, flush mounting page 38
-  Slow-make switching element stackable, front mounting page 42

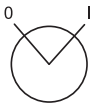

	Front protection	Switching action	Key remove	Front ring	Typ-Nr.	Component layout	Mounting dimensions	Technical drawing	Circuit drawing	
<b>Keylock switch actuator 2 positions, flush mounting</b> Position 0 : Basic position Position I : Maintained action 90° Standard lock 9500 up to 3 Switching elements max. in 1st level	IP 65	MA	0	Plastic matt-chrome	<b>44-730.21</b>	4	5	34	30	0.051
				Plastic matt-grey	<b>44-730.61</b>	4	5	34	30	0.051
			0 + I	Plastic matt-chrome	<b>44-730.22</b>	4	5	34	30	0.051
				Plastic matt-grey	<b>44-730.62</b>	4	5	34	30	0.051
Position 0 : Basic position Position I : Momentary action 90° Standard lock 9500 up to 3 Switching elements max. in 1st level	IP 65	M	0	Plastic matt-chrome	<b>44-732.21</b>	4	5	34	27	0.051
				Plastic matt-grey	<b>44-732.61</b>	4	5	34	27	0.051

Other lock numbers on request



Switching action: MA = Maintained action, M = Momentary action

Component layout from page 57, Mounting dimensions from page 58, Technical drawing from page 59, Circuit drawing from page 73

## Keylock switch actuator 3 positions, flush mounting



### Essential Accessories:

-  Front adapter, front mounting page 42
-  Front bezel set without label support, flush mounting page 38
-  Slow-make switching element stackable, front mounting page 42

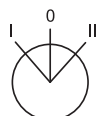

	Front protection	Switching action	Key remove	Front ring	Typ-Nr.	Component layout		Mounting dimensions	Technical drawing	Circuit drawing	
<b>Keylock switch actuator 3 positions, flush mounting</b> Position 0 : Basic position Position I : Maintained action 60° Position II : Momentary action 60° Standard lock 9500 up to 3 Switching elements max. in 1st level	IP 65	MA-0-M	0	Plastic matt-chrome	<b>44-736.21</b>	5	5	34	31	0.051	
				Plastic matt-grey	<b>44-736.61</b>	5	5	34	31	0.051	
			I + 0	Plastic matt-chrome	<b>44-736.23</b>	5	5	34	31	0.051	
				Plastic matt-grey	<b>44-736.63</b>	5	5	34	31	0.051	
Position 0 : Basic position Position I : Momentary action 60° Position II : Maintained action 60° Standard lock 9500 up to 3 Switching elements in 1st level	IP 65	M-0-MA	0	Plastic matt-chrome	<b>44-737.21</b>	5	5	34	29	0.051	
				Plastic matt-grey	<b>44-737.61</b>	5	5	34	29	0.051	
			0 + II	Plastic matt-chrome	<b>44-737.24</b>	5	5	34	29	0.051	
				Plastic matt-grey	<b>44-737.64</b>	5	5	34	29	0.051	
Position 0 : Basic position Position I + II : Maintained action 60° Standard lock 9500 up to 3 Switching elements in 1st level	IP 65	MA-0-MA	0	Plastic matt-chrome	<b>44-734.21</b>	5	5	34	32	0.051	
				Plastic matt-grey	<b>44-734.61</b>	5	5	34	32	0.051	
			0 + II	Plastic matt-chrome	<b>44-734.24</b>	5	5	34	32	0.051	
				Plastic matt-grey	<b>44-734.64</b>	5	5	34	32	0.051	
			I + 0	Plastic matt-chrome	<b>44-734.23</b>	5	5	34	32	0.051	
				Plastic matt-grey	<b>44-734.63</b>	5	5	34	32	0.051	
			I + 0 + II	Plastic matt-chrome	<b>44-734.25</b>	5	5	34	32	0.051	
				Plastic matt-grey	<b>44-734.65</b>	5	5	34	32	0.051	
Position 0 : Basic position Position I + II : Momentary action 60° Standard lock 9500 up to 3 Switching elements max. in 1st level	IP 65	M-0-M	0	Plastic matt-chrome	<b>44-735.21</b>	5	5	34	28	0.051	
				Plastic matt-grey	<b>44-735.61</b>	5	5	34	28	0.051	

Other lock numbers on request



Switching action: MA = Maintained action, M = Momentary action

Component layout from page 57, Mounting dimensions from page 58, Technical drawing from page 59, Circuit drawing from page 73

## Selector switch actuator 2 positions, flush mounting



### Essential Accessories:

-  Front adapter, front mounting page 42
-  Front bezel set without label support, flush mounting page 38
-  Slow-make switching element stackable, front mounting page 42

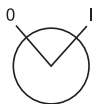

	Front protection	Switching action	Lever	Front ring	Typ-Nr.	Component layout	Mounting dimensions	Technical drawing	Circuit drawing	
<b>Selector switch actuator 2 positions, flush mounting</b> Position 0 : Basic position Position I : Maintained action 90° up to 3 Switching elements max. in 1st level	IP 65	MA	Plastic black	Plastic matt-chrome	<b>44-720.20</b>	4	5	26	14	0.021
			Plastic grey	Plastic matt-grey	<b>44-720.68</b>	4	5	26	14	0.021
			Plastic red	Plastic matt-chrome	<b>44-720.22</b>	4	5	26	14	0.021
				Plastic matt-grey	<b>44-720.62</b>	4	5	26	14	0.021
Position 0 : Basic position Position I : Momentary action 90° up to 3 Switching elements in 1st level	IP 65	M	Plastic black	Plastic matt-chrome	<b>44-722.20</b>	4	5	26	11	0.021
			Plastic grey	Plastic matt-grey	<b>44-722.68</b>	4	5	26	11	0.021



Switching action: MA = Maintained action, M = Momentary action

Component layout from page 57, Mounting dimensions from page 58, Technical drawing from page 59, Circuit drawing from page 73

## Selector switch actuator 3 positions, flush mounting



### Essential Accessories:

-  Front adapter, front mounting page 42
-  Front bezel set without label support, flush mounting page 38
-  Slow-make switching element stackable, front mounting page 42

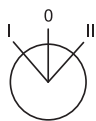

	Front protection	Switching action	Lever	Front ring	Typ-Nr.	Component layout		Mounting dimensions	Technical drawing	Circuit drawing	
<b>Selector switch actuator 3 positions, flush mounting</b> Position 0 : Basic position Position I : Maintained action 60° Position II : Momentary action 60° up to 3 Switching elements max. in 1st level	IP 65	MA-0-M	Plastic black	Plastic matt-chrome	<b>44-726.20</b>	5	5	26	15	0.021	
			Plastic grey	Plastic matt-grey	<b>44-726.68</b>	5	5	26	15	0.021	
Position 0 : Basic position Position I : Momentary action 60° Position II : Maintained action 60° up to 3 Switching elements max. in 1st level	IP 65	M-0-MA	Plastic black	Plastic matt-chrome	<b>44-727.20</b>	5	5	26	13	0.021	
			Plastic grey	Plastic matt-grey	<b>44-727.68</b>	5	5	26	13	0.021	
Position 0 : Basic position Position I + II : Maintained action 60° up to 3 Switching elements max. in 1st level	IP 65	MA-0-MA	Plastic black	Plastic matt-chrome	<b>44-724.20</b>	5	5	26	16	0.021	
			Plastic grey	Plastic matt-grey	<b>44-724.68</b>	5	5	26	16	0.021	
Position 0 : Basic position Position I + II : Momentary action 60° up to 3 Switching elements max. in 1st level	IP 65	M-0-M	Plastic black	Plastic matt-chrome	<b>44-725.20</b>	5	5	26	12	0.021	
			Plastic grey	Plastic matt-grey	<b>44-725.68</b>	5	5	26	12	0.021	



Switching action: MA = Maintained action, M = Momentary action

Component layout from page 57, Mounting dimensions from page 58, Technical drawing from page 59, Circuit drawing from page 73

## Interlocking pushbutton actuator, flush mounting



### Essential Accessories:

-  Front adapter, front mounting page 42
-  Front bezel set without label support, flush mounting page 38
-  Slow-make switching element stackable, front mounting page 42

	Front protection	Switching action	Front ring	Rotating knob	Typ-Nr.	Mounting dimensions	Technical drawing	Circuit drawing	
<b>Interlocking pushbutton actuator, flush mounting</b> in activated state locked by turning to the right, otherwise Momentary action up to 3 Switching elements max. in 1st level	IP 65	M-MA	Plastic matt-chrome	Plastic black	<b>44-742.20</b>	5	38	19	0.020
				Plastic red	<b>44-742.22</b>	5	38	19	0.020
			Plastic matt-grey	Plastic grey	<b>44-742.68</b>	5	38	19	0.020
				Plastic red	<b>44-742.62</b>	5	38	19	0.020

Switching action: M-MA = Momentary action-Maintained action

Mounting dimensions from page 58, Technical drawing from page 59, Circuit drawing from page 73

## Potentiometer-drive, flush mounting



### Essential Accessories:

-  Front bezel set without label support, flush mounting page 38

	Front protection	Front ring	Typ-Nr.	Mounting dimensions	Technical drawing	Circuit drawing	
<b>Potentiometer-drive, flush mounting</b> Potentiometer 10 kΩ included others on request, resistance value as per IEC 63, series E3	IP 65	Plastic matt-chrome	<b>44-745.20-10K1</b>	5	1	4	0.030
		Plastic matt-grey	<b>44-745.60-10K1</b>	5	1	4	0.030
without Potentiometer Specification for Potentiometer : Shaft = length 32 mm Shaft end = Form A Diameter = 6 mm	IP 65	Plastic matt-chrome	<b>44-744.20</b>	5	1		0.016
		Plastic matt-grey	<b>44-744.60</b>	5	1		0.016

Mounting dimensions from page 58, Technical drawing from page 59, Circuit drawing from page 73

## Front

### Lens

	Lens	Ø 28 mm Typ-Nr.	
<b>Lens</b> for Indicator and Illuminated pushbutton, front illumination Pushbutton markable	Plastic blue transparent flush	<b>44-966.6</b>	0.001
	Plastic colourless transparent flush	<b>44-966.7</b>	0.001
	Plastic green transparent flush	<b>44-966.5</b>	0.001
	Plastic red transparent flush	<b>44-966.2</b>	0.001
	Plastic yellow transparent flush	<b>44-966.4</b>	0.001



### Marking plate for Lens

	Marking plate	Typ-Nr.	
<b>Marking plate for Lens</b> for Indicator and Illuminated pushbutton, front illumination Pushbutton markable	Plastic white translucent	<b>44-962.9</b>	0.001
	Plastic black opaque	<b>44-961.0</b>	0.001
for Pushbutton markable	Plastic blue opaque	<b>44-961.6</b>	0.001
	Plastic green opaque	<b>44-961.5</b>	0.001
	Plastic red opaque	<b>44-961.2</b>	0.001
	Plastic yellow opaque	<b>44-961.4</b>	0.001



Marking information see in chapter Marking

### Lens cap

	Lens cap	Ø 28 mm Typ-Nr.	
<b>Lens cap</b> for Indicator full face illumination with sealing ring	Plastic blue transparent	<b>44-965.6</b>	0.003
	Plastic colourless transparent	<b>44-965.7</b>	0.003
	Plastic green transparent	<b>44-965.5</b>	0.003
	Plastic red transparent	<b>44-965.2</b>	0.003
	Plastic yellow transparent	<b>44-965.4</b>	0.003



### Front bezel set without label support, flush mounting

	Front bezel	□ 36 x 36 mm Typ-Nr.	Ø 36 mm Typ-Nr.	Technical drawing	
<b>Front bezel set without label support, flush mounting</b> for Illuminated pushbutton and Pushbutton, Selector- and Keylock switch, Interlocking pushbutton the mounting depth extends for 12 mm	Plastic black	<b>44-946.03</b>	<b>44-946.03-A</b>	43	0.010
	Plastic black	<b>44-946.01</b>	<b>44-946.01-A</b>	43	0.006



Technical drawing from page 59



## Front bezel set with label support, flush mounting

	Front bezel	Typ-Nr.	Technical drawing	
<b>Front bezel set with label support, flush mounting</b> for Illuminated pushbutton and Pushbutton, Selector- and Keylock switch, Interlocking pushbutton the mounting depth extends for 12 mm	Plastic black	<b>44-946.04</b>	43	0.011
for Indicator and Potentiometer the mounting depth extends for 3 mm	Plastic black	<b>44-946.02</b>	43	0.007



Technical drawing from page 59

## Label for front bezel set with label support, flush mounting

	Typ-Nr.	
<b>Label for front bezel set with label support, flush mounting</b> 27 x 18 mm, adhesive, plastic (2 layers Aluminium/black)	<b>44-946</b>	0.001
27 x 18 mm, adhesive, plastic (2 layers black/white)	<b>44-946.0</b>	0.001



Marking information see in chapter Marking

## Legend plate

	Typ-Nr.	Technical drawing	
<b>Legend plate</b> 30 x 60 mm, Aluminium natural, for engraving, for protection IP 40	<b>44-955</b>	8	0.001



Technical drawing from page 59

## Label support without label

label to be ordered separatly (44-960)

	Typ-Nr.	Technical drawing	
<b>Label support without label</b> 29.5 x 49.5 mm, plastic black, remove sealing ring from actuator	<b>44-944.00</b>	7	0.002
	<b>44-944.08</b>	7	0.002



Technical drawing from page 59

## Label support with label

	Typ-Nr.	Technical drawing	
<b>Label support with label</b> 29.5 x 49.5 mm, plastic black, label unmarked, remove sealing ring from actuator	<b>44-945.00</b>	7	0.002
29.5 x 49.5 mm, plastic grey, label unmarked, remove sealing ring from actuator	<b>44-945.08</b>	7	0.002



Technical drawing from page 59

## Label for Label support with label

	Typ-Nr.	
<b>Label for Label support with label</b> 13 x 26 mm, Aluminium black	<b>44-960</b>	0.001



Marking information see in chapter Marking

## Front ring flush

	Front ring	Typ-Nr.	
<b>Front ring flush</b> for Illuminated Pushbutton- and Pushbutton actuator	Plastic matt-chrome	<b>44-967.2</b>	0.002
	Plastic matt-grey	<b>44-967.6</b>	0.002



## Front ring raised

	Front ring	Typ-Nr.	
<b>Front ring raised</b> for Pushbutton actuator	Plastic matt-chrome	<b>44-968.2</b>	0.003
	Plastic matt-grey	<b>44-968.6</b>	0.003



## Protective cover

	Typ-Nr.	Technical drawing	
<b>Protective cover</b> for Illuminated Pushbutton and Pushbutton with flush Front ring hinged, transparent, with means for sealing, front panel thickness up to 3 mm max. Remove anti-twisting nose from the actuator.	<b>44-922</b>	9	0.007



Technical drawing from page 59

## Front protective cap

	Front protective cap	Typ-Nr.	
<b>Front protective cap</b> only in connection with flush Front ring. Protection when used under adverse ambient conditions. Remove gasket from the actuator. Cannot be used with the label support.	Silicone colourless transparent	<b>44-917.07</b>	0.002



## Keylock cap

	Keylock cap	Typ-Nr.	
<b>Keylock cap</b> for Keylock pushbutton, standard mounting. Protection when used under adverse ambient conditions. Remove gasket from the actuator. Cannot be used with the label support.	Plastic black	<b>44-921.00</b>	0.004
	Plastic grey	<b>44-921.08</b>	0.004



## Blind plug

	Blind plug	Typ-Nr.	Mounting dimensions	Technical drawing	
<b>Blind plug</b> Mounting hole size 22.5 mm Lamp transformer can be mounted with front adaptor	Plastic grey	<b>44-915</b>	1	5	0.008



Mounting dimensions from page 58, Technical drawing from page 59

## Spare key

	Typ-Nr.	
<b>Spare key</b> Standard lock 9500	<b>44-919</b>	0.007



Other lock numbers on request

## Backside

### Front adapter, front mounting

	Marking	Typ-Nr.	Technical drawing	
<b>Front adapter, front mounting</b> for Switching element or Lamp element	without	<b>44-900</b>	2	0.007
for Switching elements in 1. level	1 3 2	<b>44-901</b>	2	0.007
for Switching elements in 2. level	1/2 5/6 4/3	<b>44-902</b>	2	0.007
for Switching elements in 3. level	1/2/3 7/8/9 6/5/4	<b>44-903</b>	2	0.007



Front adaptor marking :

Terminal marking and distinctive number as per DIN EN 50013. The operating characters are marked on the switching elements beside the screw terminals

Technical drawing from page 59

### Slow-make switching element stackable, front mounting

	Switch rating	Contacts	Contact material	Terminals	Typ-Nr.	Technical drawing	Circuit drawing	
<b>Slow-make switching element stackable, front mounting</b> Forced opening as per EN IEC 947-5-1	500 VAC, 10 A	1 NC	Au/Ag	ST	<b>44-152</b>	39	38	0.014
			Hard silver	ST	<b>44-151</b>	39	38	0.014
		1 NC + 1 NO	Au/Ag	ST	<b>44-132</b>	39	35	0.017
			Hard silver	ST	<b>44-131</b>	39	35	0.017
		1 NO	Au/Ag	ST	<b>44-162</b>	39	39	0.014
			Hard silver	ST	<b>44-161</b>	39	39	0.014
overlapping, not to use with Emergency-stop switch	500 VAC, 10 A	1 NC + 1 NO	Hard silver	ST	<b>44-141</b>	39	36	0.017



Contacts: NC = Normally closed, NO = Normally open

Contact material: Au/Ag = Gold/Silver

Terminals: ST = Screw terminal

Technical drawing from page 59, Circuit drawing from page 73

## Slow-make switching element non-stachable, front mounting

	Switch rating	Contacts	Contact material	Terminals	Typ-Nr.	Technical drawing	Circuit drawing	
<b>Slow-make switching element non-stachable, front mounting</b>	500 VAC, 10 A	1 NO	Hard silver	ST	<b>44-121</b>	39	39	0.010
Forced opening as per EN IEC 947-5-1	500 VAC, 10 A	1 NC	Hard silver	ST	<b>44-111</b>	39	38	0.010



Contacts: NO = Normally open, NC = Normally closed  
 Terminals: ST = Screw terminal  
 Technical drawing from page 59, Circuit drawing from page 73

## Lamp element, front mounting

	Terminals	Typ-Nr.	Technical drawing	Circuit drawing	
<b>Lamp element, front mounting</b> Lamp socket BA9s, max. 2.6 W	ST	<b>44-524</b>	40	3	0.011



Terminals: ST = Screw terminal  
 Technical drawing from page 59, Circuit drawing from page 73

## Base adaptor

	Marking	Typ-Nr.	
<b>Base adaptor</b>	1 3 2	<b>44-905</b>	0.006



Front adaptor marking :  
 Terminal marking and distinctive number as per DIN EN 50013. The operating characters are marked on the switching elements beside the screw terminals

## Slow-make switching element non-stackable, base mounting

	Switch rating	Contacts	Contact material	Terminals	Typ-Nr.	Technical drawing	Circuit drawing	
<b>Slow-make switching element non-stackable, base mounting</b>	500 VAC, 10 A	1 NO	Hard silver	ST	<b>44-221</b>	41	39	0.010
Forced opening as per EN IEC 947-5-1	500 VAC, 10 A	1 NC	Hard silver	ST	<b>44-211</b>	41	38	0.010



Contacts: NO = Normally open, NC = Normally closed  
 Terminals: ST = Screw terminal  
 Technical drawing from page 59, Circuit drawing from page 73

## Lamp, base mounting

	Terminals	Typ-Nr.	Technical drawing	Circuit drawing	kg
<b>Lamp, base mounting</b> Lamp socket Ba9s, max. 2.6 W	ST	<b>44-525</b>	4	3	0.011



Terminals: ST = Screw terminal

Technical drawing from page 59, Circuit drawing from page 73

## Blind element

	Typ-Nr.	Technical drawing	kg
<b>Blind element</b> for mounting of Lamp transformer	<b>44-940</b>	6	0.008



Technical drawing from page 59

## Illumination

### Filament lamp

The max. overall length of the lamp may not exceed 25 mm

	Socket	Operating voltage/-current	Typ-Nr.	kg
<b>Filament lamp</b>	BA9s	110 VAC/DC, 22 mA	<b>10-1422.1179</b>	0.002
		12 VAC/DC, 100 mA	<b>10-1409.1329</b>	0.002
		130 VAC/DC, 20 mA	<b>10-1424.1179</b>	0.002
		24 VAC/DC, 50 mA	<b>10-1412.1279</b>	0.002
		36 VAC/DC, 56 mA	<b>10-1416.1289</b>	0.002
		48 VAC/DC, 42 mA	<b>10-1419.1249</b>	0.002
		6 VAC/DC, 200 mA	<b>10-1406.1369</b>	0.002
		60 VAC/DC, 33 mA	<b>10-1420.1219</b>	0.002



## Single-LED

The max. overall length of the lamp may not exceed 25 mm

Single-LED	Socket	Light colour	Operating voltage/-current	Typ-Nr.	
Single-LED	BA9s	blue	12 VAC/DC, 16 mA	<b>10-2509.1146</b>	0.002
			130 VAC, 5 mA	<b>10-2H24.2056</b>	0.002
			230 VAC, 3 mA	<b>10-2H25.2046</b>	0.002
			24 VAC/DC, 15 mA	<b>10-2512.1146</b>	0.002
			28 VAC/DC, 13 mA	<b>10-2513.1146</b>	0.002
			48 VAC/DC, 4/8 mA	<b>10-2519.1056</b>	0.002
			6 VDC, 17 mA	<b>10-2506.1086</b>	0.002
		green	12 VAC/DC, 16 mA	<b>10-2509.1145</b>	0.002
			130 VAC, 5 mA	<b>10-2H24.2055</b>	0.002
			230 VAC, 3 mA	<b>10-2H25.2045</b>	0.002
			24 VAC/DC, 15 mA	<b>10-2512.1145</b>	0.002
			28 VAC/DC, 13 mA	<b>10-2513.1145</b>	0.002
			48 VAC/DC, 4/8 mA	<b>10-2519.1055</b>	0.002
			6 VDC, 17 mA	<b>10-2506.1085</b>	0.002
		red	12 VAC/DC, 16 mA	<b>10-2509.1142</b>	0.002
			130 VAC, 5 mA	<b>10-2H24.2052</b>	0.002
			230 VAC, 3 mA	<b>10-2H25.2042</b>	0.002
			24 VAC/DC, 15 mA	<b>10-2512.1142</b>	0.002
			28 VAC/DC, 13 mA	<b>10-2513.1142</b>	0.002
			48 VAC/DC, 4/8 mA	<b>10-2519.1052</b>	0.002
			6 VDC, 17 mA	<b>10-2506.1082</b>	0.002
		white diffuse	12 VAC/DC, 16 mA	<b>10-2509.1149</b>	0.002
			130 VAC, 5 mA	<b>10-2H24.2059</b>	0.002
			230 VAC, 3 mA	<b>10-2H25.2049</b>	0.002
			24 VAC/DC, 15 mA	<b>10-2512.1149</b>	0.002
			28 VAC/DC, 13 mA	<b>10-2513.1149</b>	0.002
			48 VAC/DC, 4/8 mA	<b>10-2519.1059</b>	0.002
			6 VDC, 17 mA	<b>10-2506.1089</b>	0.002
		yellow	12 VAC/DC, 16 mA	<b>10-2509.1144</b>	0.002
			130 VAC, 5 mA	<b>10-2H24.2054</b>	0.002
			230 VAC, 3 mA	<b>10-2H25.2044</b>	0.002
			24 VAC/DC, 15 mA	<b>10-2512.1144</b>	0.002
			28 VAC/DC, 13 mA	<b>10-2513.1144</b>	0.002
			48 VAC/DC, 4/8 mA	<b>10-2519.1054</b>	0.002
			6 VDC, 17 mA	<b>10-2506.1084</b>	0.002



**Note:**

AC operation through halve-wave rectifier possible, slight flickering can occur.

12, 24, 28, 48 VAC/DC versions with bridge rectifier. Used on a DC voltage and AC voltage with the same light output.

## Resistor diode element

	Diode (1N 4007)	Operating voltage	Terminals	Typ-Nr.	Technical drawing	kg
<b>Resistor diode element</b> for front- and base mounting for Incandescent lamp 130 V, 2.4 W	1 D	220 ... 240 VAC	ST	<b>44-614.11</b>	3	0.009
for front- and base mounting for Incandescent lamp 60 V, 1.2 W	1 D	110 ... 125 VAC	ST	<b>44-614.12</b>	3	0.009
for front mounting for Incandescent lamp 130 V, 2.4 W	2 D	220 ... 240 VAC	ST	<b>44-614.21</b>	3	0.015
for front mounting for Incandescent lamp 60 V, 1.2 W	2 D	110 ... 125 VAC	ST	<b>44-614.22</b>	3	0.015



Diode (1N 4007): D = Diode  
Terminals: ST = Screw terminal  
Technical drawing from page 59

## Diode element

	Diode (1N 4007)	Terminals	Typ-Nr.	Technical drawing	kg
<b>Diode element</b> for front- and base mounting	1 D	ST	<b>44-612.1</b>	3	0.009
	2 D	ST	<b>44-612.2</b>	3	0.011



Diode (1N 4007): D = Diode  
Terminals: ST = Screw terminal  
Technical drawing from page 59

## Lamp transformer

	Operating voltage	Terminals	Typ-Nr.	Technical drawing	kg
<b>Lamp transformer</b> Short-circuit proof, 1.2 VA, 50/60 Hz, for front or base mounting	125 AC / 24 VAC	ST	<b>44-975</b>	42	0.102
	125 VAC / 6 VAC	ST	<b>44-970</b>	42	0.102
	230 VAC / 24 VAC	ST	<b>44-976</b>	42	0.102
	230 VAC / 6 VAC	ST	<b>44-971</b>	42	0.102
	400 VAC / 24 VAC	ST	<b>44-977</b>	42	0.102
	400 VAC / 6 VAC	ST	<b>44-972</b>	42	0.102



Terminals: ST = Screw terminal  
Technical drawing from page 59



## Series resistor

for lamp voltage reduction

	Operating voltage	Typ-Nr.	
<b>Series resistor</b> 10 kΩ, for filament lamp 48 V / 1.2 W	240 V	<b>44-957.050</b>	0.002
2.7 kΩ, for filament lamp 48 V / 1.2 W	110 V	<b>44-957.010</b>	0.002
3.3 kΩ, for filament lamp 48 V / 1.2 W	125 V	<b>44-957.020</b>	0.002
4.7 kΩ, for filament lamp 48 V / 1.2 W	145 V	<b>44-957.030</b>	0.002
6. kΩ, for filament lamp 110 ... 130 V / 2.4 W	230 V	<b>44-957.060</b>	0.002



Please keep to the country specific security rules.

## Terminal plate empty

for fitting with series resistors

	Typ-Nr.	
<b>Terminal plate empty</b> 10 spaces 125 x 60 x 15 mm	<b>44-959.10</b>	0.045
15 spaces 187.5 x 60 x 15 mm	<b>44-959.15</b>	0.090
20 spaces 250 x 60 x 15 mm	<b>44-959.20</b>	0.106
5 spaces 62.5 x 60 x 15 mm	<b>44-959.05</b>	0.025



## Emergency-stop pushbutton

### Emergency-stop label

	Marking	Typ-Nr.	
<b>Emergency-stop label</b> 45 mm dia., yellow, adhesiv Front protection IP 65 when protection foil is removed	ARRET-D'URGENCE	<b>44-951.3</b>	0.002
	EMERGENCY-STOP	<b>44-951.2</b>	0.002
	NOT HALT	<b>44-951.4</b>	0.002
	NOT-AUS	<b>44-951.1</b>	0.002
	without	<b>44-951</b>	0.002
60 mm dia., yellow, adhesiv Front protection IP 65 when protection foil is removed	ARRET-D'URGENCE	<b>44-950.3</b>	0.004
	EMERGENCY-STOP	<b>44-950.2</b>	0.004
	NOT HALT	<b>44-950.4</b>	0.004
	NOT-AUS	<b>44-950.1</b>	0.004
	without	<b>44-950</b>	0.004
90 mm dia., yellow, adhesiv Front protection IP 65 when protection foil is removed	ARRET-D'URGENCE	<b>44-949.3</b>	0.009
	EMERGENCY-STOP	<b>44-949.2</b>	0.009
	NOT HALT	<b>44-949.4</b>	0.009
	NOT-AUS	<b>44-949.1</b>	0.009
	without	<b>44-949</b>	0.009



## Emergency-stop enclosures

Colour yellow

	Dimension	Typ-Nr.	Technical drawing	
<b>Emergency-stop enclosures</b> 1 Mounting hole, with adaptor for base mounting	L 84 mm, W 72 mm, H 64 mm	<b>44-001.4</b>	44	0.174



Technical drawing from page 59

## Cable gland

	Typ-Nr.	
<b>Cable gland</b> for Enclosure M20, with nut and sealing, fixing area 7 ... 13 mm dia.	<b>44-956</b>	0.009



## Assembling

### Enclosure

Colour light grey

	Dimension	Typ-Nr.	Technical drawing	
<b>Enclosure</b> 1 Mounting hole, with adaptor for base mounting	L 84 mm, W 72 mm, H 64 mm	<b>44-001.8</b>	44	0.175
2 Mounting holes, with adaptor for base mounting	L 117 mm, W 72 mm, H 64 mm	<b>44-002.8</b>	44	0.199
3 Mounting holes, with adaptor for base mounting	L 150 mm, W 72 mm, H 64 mm	<b>44-003.8</b>	44	0.252
5 Mounting holes, with adaptor for base mounting	L 215 mm, W 72 mm, H 64 mm	<b>44-005.8</b>	44	0.332



Technical drawing from page 59

### Label for enclosure

	Typ-Nr.	
<b>Label for enclosure</b> 19 x 19 mm, adhesive, plastic, Aluminium plated (natural), unmarked,	<b>44-963</b>	0.001



## Cable gland

	Typ-Nr.	
<b>Cable gland</b> for Enclosure M20, with nut and sealing, fixing area 7 ... 13 mm dia.	<b>44-956</b>	0.009



## Reducing ring

	Typ-Nr.	
<b>Reducing ring</b> Aluminium natural, Mounting hole size 30.5 mm dia., 2 Reducing rings are required for each mounting hole	<b>44-925</b>	0.003



## Mounting tool

	Typ-Nr.	
<b>Mounting tool</b> for Fixing nut, transparent Lens, Lens caps and Illumination	<b>44-935</b>	0.037



## Slow-make switching element

### Switching system

The double-break switching system can be supplied for the following switching functions: 1 normally closed, 1 normally open or 1 changeover contact with or without overlap.

The normally closed contacts have forced opening according to DIN 0660, IEC 60947-5-1 and DIN VDE 0113.

The switching element exhibits high reliability due to its H-contact system with relative friction. The normally open and normally closed contacts can be used electrically separated.

The standard version is ideal for high breaking capacities. For lower capacities a special version can be supplied.

### Material

#### Material of contact

Standard version: Ag-Ni alloy  
special version: Gold/Silver

#### Plastics

UL listed, Cd-free

#### Switching element

PC, PA 6.6 self-extinguishing

### Mechanical characteristics

#### Actuating force

per switching element  $\leq 5$  N  
Illuminated pushbutton actuator  $\leq 10$  N  
Stop pushbutton actuator  $\leq 20$  N  
Emergency-stop pushbutton actuator foolproof  $\leq 70$  N  
Double pushbutton  $\leq 12$  N per contact surface

#### Actuating travel

approx. 6 mm

#### Mechanical lifetime

Slow-make switching element  $10 \times 10^6$  switching operations  
Pushbutton momentary action  $5 \times 10^6$  switching operations  
Pushbutton maintained action  $1 \times 10^6$  cycles of operation  
Illuminated pushbutton momentary action  $3 \times 10^6$  switching operations  
Illuminated pushbutton maintained action  $1 \times 10^6$  cycles of operation  
Interlocking pushbutton  $2 \times 10^5$  switching operations  
Stop pushbutton not foolproof  $1 \times 10^5$  cycles of operation  
Emergency-stop foolproof  $>6050$  cycles of operation  
Keylock switch  $2 \times 10^5$  cycles of operation  
Selector switch  $2 \times 10^5$  cycles of operation  
Double pushbutton  $2 \times 10^5$  switching operations per contact surface

### Electrical characteristics

#### Rated Insulation Voltage $U_i$

Slow-make switching element 660 V  
Lamp element 250 V  
Lamp transformer 660 V

#### Rated Operational Voltage $U_e$

AC 15 (inductive)  
120 V,  $\sim 6$  A  
230 V,  $\sim 6$  A  
400 V,  $\sim 4$  A  
500 V,  $\sim 3$  A  
600 V,  $\sim 1.2$  A  
DC 13

24 V, 3 A  
60 V, 1.3 A  
120 V, 0.6 A  
250 V, 0.3 A

#### Rated Impulse Withstand Voltage $U_{imp}$

Lamp element 2,5 kV  
Lamp transformer 6 kV  
Slow-make switching element 6 kV\*

\* between the electrically separated normally closed contacts and normally open contacts for slow-make switching elements.

1 NC + 1 NO without overlap

$U_e > 400$  V, same polarity

$U_{imp} = 4000$  V

1 NC + 1 NO with overlap

$U_e > 250$  V, same polarity

$U_{imp} = 4000$  V

#### Rated Operational Current $I_e$

AC-12 (resistive)

500 V,  $\sim 5$  A

DC-12

24 V, 10 A

60 V, 8 A

125 V, 3 A

250 V, 1 A

#### Contact resistance

Starting value (initial)  $\leq 50$  m $\Omega$

#### Electrical life

AC-15

400 V,  $\sim 2$  A,  $1 \times 10^6$  switching operations

#### Conventional free air thermal current

$I_{th2} = 10$  A

#### Short-circuit protection

max. series fuse to be provided 10 A gL  
lamp transformer is short-circuit-protected

#### Switch rating

Ag-Ni alloy

(Standard version) minimal 6 V, 20 mA  
minimal 12 V, 10 mA

Gold/Silver

(Special version) minimal 5 V, 1 mA  
maximum 42 V, 100 mA

#### Degree of pollution

3, as per EN IEC 60947-1

### Environmental conditions

#### Storage temperature

$-40$  °C ...  $+70$  °C

#### Operating temperature

$-25$  °C, as per EN IEC 60068-2-1  
 $+60$  °C, as per EN IEC 60068-2-2

#### Protection degree

Actuators at front and enclosure IP 65, as per EN IEC 60529

#### Shock resistance

40 g (duration 6 ms), as per EN IEC 60 68-2-27

#### Vibration resistance

sinusoidal, 5 g at 10-500 Hz, as per EN IEC 60068-2-6

## Climate resistance

Humidity and heat constant, as per EN IEC 60068-2-3  
Humidity and heat cyclic, as per EN IEC 60068-2-30

## Approvals

### Approbations

CSA  
Germanischer Lloyd  
UL  
VDE

### Declaration of conformity

CE  
RoHS

## Actuator

## Material

### Adapter and enclosure

PC

### Front parts

PA 6, PA 12, PC, chromium-plated ABS

## Snap-action switching element Control Switch

## Switching system

Is equipped with double-break jump contacts. Owing to the large cleaning path, outstanding self-cleaning is possible. The multilayer contacts are designed for universal use. They are gilded with a 2 µm gold coating. Each snap-action switching element comprises a NC (normally closed contact) and a NO (normally open contact).

## Material

### Housing

Polyethylene terephthalate (PETP), as per UL 94 V0

### Contacts

AgNi, 2 µm gold plated

### Contact carrier

Brass or CuBe

## Mechanical characteristics

### Terminals

Soldering terminal (also pluggable 2.8 x 0.5 mm), Brass gold plated  
Wire cross-section 1.0 mm<sup>2</sup> max.

### Actuating force

For each snap-action switching element approx. 2 N

### Rebound time

typically 0.5 µs

### Contact opening width

2 x 0.65 mm

### Contact cleaning path

2 x 0.6 mm

### Mechanical lifetime

2 million cycles of operation

## Electrical characteristics

### Contact resistance

New state with gold plated contact ≤50 mΩ, statically

### Electrical life

>10 000 cycles of operation

### Switch rating

as per EN IEC 61058-1  
250 VAC, 5 A cosφ 0.7 ... 0.8  
250 VDC, 0.5 A  
110 VDC, 2A  
75 VDC, 5 A  
5 VAC/DC, 1 mA min.

## Approvals

### Approbations

CSA  
ENEC (EN 61058)  
UL  
VDE

### Declaration of conformity

CE  
RoHS

## Control Switch

## General

### Design

Modular, Actuator and Switch part separated

### Operation

2-/ 4-/ 8-positions, each approx. 12°

### Mounting position

In any way

## Mechanical characteristics

### Mechanical lifetime

2 million cycles of operation

## Environmental conditions

### Storage temperature

-40 °C ... +85 °C, as per EN IEC 60068

### Operating temperature

-25 °C ... +55 °C, as per EN IEC 60068-2

### Protection degree

IP 65 front side, as per IEC 60529

### Shock resistance

40 g, 6 ms regarding mechanical destruction

### Climate resistance

Damp heat state/cyclic as per EN IEC 60068-2

## Wiring diagrams for central lamp test

Diode element with 1 diode

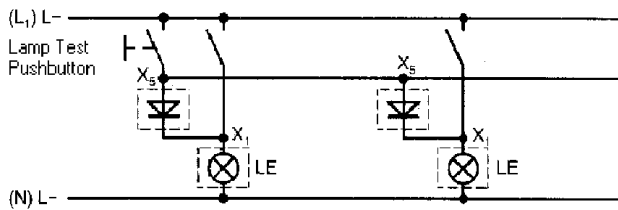

Diode element with 2 diode

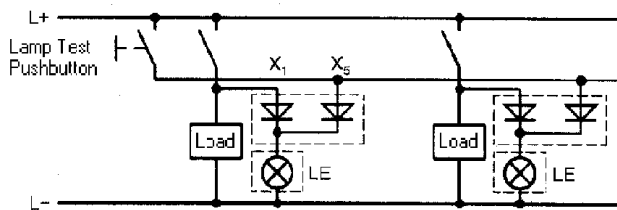

Diode resistance element

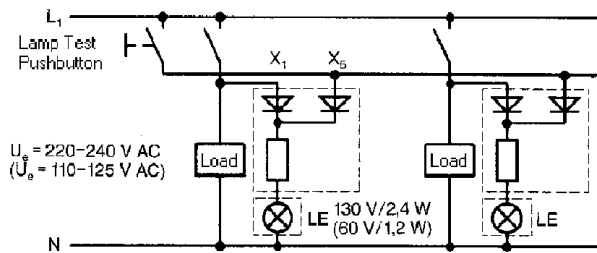

- Only apply incandescent lamps with special data !  
 Incandescent lamp 130 V, 2.4 W, Typ-Nr. 10-1423.1179  
 Incandescent lamp 60 V, 1.2 W, Typ-Nr. 10-1420.1179
- Max. environmental temperature 40 °C for Resistor diode element Typ-Nr. 44-614.11 und 44-614.21
- For base mounting of the diode element Typ-Nr. 44612.2 the connection wire which just comes out in the middle must be placed so that it does not interfere with the actuator system.

## Suppressor circuits

When switching inductive loads such as relays, DC motors, and DC solenoids, it is always important to absorb surges (e.g. with a diode) to protect the contacts. When these inductive loads are switched off, a counter emf can severely damage switch contacts and greatly shorten lifetime.

Fig. 1 shows an inductive load with a free-wheeling diode connected in parallel. This free-wheeling diode provides a path for the inductor current to flow when the current is interrupted by the switch. Without this free-wheeling diode, the voltage across the coil will be limited only by dielectric breakdown voltages of the circuit or parasitic elements of the coil. This voltage can be kilovolts in amplitude even when nominal circuit voltages are low (e.g. 12 VDC) see Fig. 2.

The free-wheeling diode should be chosen so that the reverse breakdown voltage is greater than the voltage driving the inductive load. The DC blocking voltage (VR) of the free-wheeling diode can be found in the datasheet of a diode. The forward current should be equal or greater than the maximum current flowing through the load.

**To get an efficient protection, the free-wheeling diode must be connected as close as possible to the inductive load!**

Switching with inductive load  
Fig. 1



Counter emf  
over load without free-wheeling diode  
Fig. 2



## Label marking for label support

Label black anodized

Standard text	Text-No.	Standard text	Text-No.	Standard text	Text-No.
0	T 01	Forwards	T 14	Set up	T 22
I	T 02	Revers	T 15	Raise	T 23
0 I	T 03	Right	T 16	Lower	T 24
I 0 II	T 04	Left	T 17	Hand	T 25
OFF	T 10	Halt	T 18	STOP	T 26
ON	T 11	Close	T 19	START	T 27
Up	T 12	Fast	T 20	HAND/AUTO	T 28
Down	T 13	Slow	T 21	OFF/ON	T 29





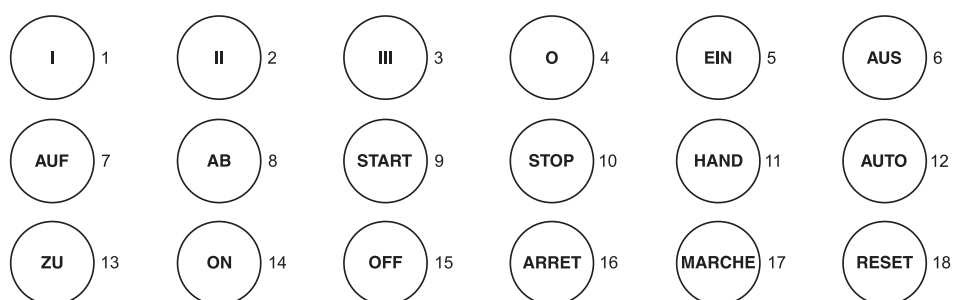























































## Standard texts for marking plates and marking caps for Indicator and Illuminated Pushbutton

Height of letters 6 mm





























## Symbols for marking plates and marking caps for Indicator and Illuminated Pushbutton

	1 Direction of linear rectilinear motion (also for $\rightarrow \updownarrow$ )		13 Direction of spindle rotation		29 Decrease of value (speed, for instance)		49 Cooling pump
	2 Linear motion in 2 directions (also for $\updownarrow$ )		14 One revolution		30 Speed of planing cut		50 Lubricant pump
	3 Interrupted linear motion (also for $\leftarrow \updownarrow$ )		15 Number of revolutions per minute (spindle speed)		31 Speed of turning cut		51 Hydraulic system pump
	4 Limited linear motion (also for $\leftarrow \updownarrow$ )		16 Feed		32 Speed of drilling cut		52 Hydraulic motor
	5 Limited linear motion and return		17 Feed per revolution		33 Speed of milling cut (similar symbol for speed of grinding)		53 Tracer
	6 Oscillating linear motion (continuous)		18 Feed per minute		34 Conventional milling		61 Stepless regulation
	7 Direction of continuous rotation (right)		19 Reduced feed		35 Climb milling (down milling)		62 Adjustable
	7a Direction of continuous rotation (left)		20 Rapid feed		41 Electric motor		63.1 Lock or tighten
	8 Rotation in 2 directions		21 Normal feed		42 Rectangular work table or slide element		63.2 Lock or tighten
	9 Direction of interrupted rotation (right)		22 Direction of feed (orientation not specified)		43 Round work table or rotating element		64.1 Unlock, unclamp
	9a Direction of interrupted rotation (left)		24 Transverse feed		44 Turning spindle		64.2 Chuck open
	10 Limited rotation (right)		25 Vertical feed		45 Drilling spindle		65 Brake on
	10a Limited rotation (left)		26 Rapid traverse		46 Milling spindle		66 Brake off
	11 Limited rotation and return		27 Threading		47 Grinding spindle		67 Automatic (or semi-automatic) cycle
	12 Oscillating rotary movement (continuous)		28 Increase of value (speed, for instance)		48 Pump (general symbol)		68 Hand control

Continuation see next page

Continued from previous page

 69 Start, on	 77 Open lock-nut	 93 Caution!	 106 Drain
 70 Stop, off	 78 Engage sensor	 94 Main switch	 107 Oil, lubricant
 71 Start and stop with same button	 79 Disengage sensor	 101 Coolant fluid	 108 Blast
 72 In action as long as button is operated	 80 Change speed only in stopped position	 102 Machine lighting	 109 Suction
 74 Engaging (mechanical start)	 81 Change speed only in motion	 103 Weight	
 75 Disengaging (mechanical stop)	 91 Shear pin construction	 104 Filter opening	
 76 Close lock-nut	 92 Danger (high voltage)	 105 Overflow	

## Component layout

### 1 Control switch page 11

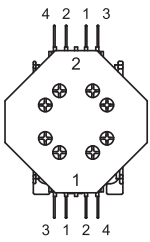

### 2 Control switch page 11

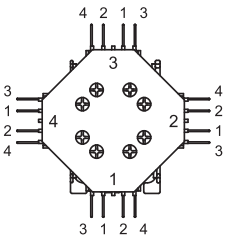

### 3 Double pushbutton actuator page 18

Arrangement switching element corresponds to designation of front adaptor

1	3	2
---	---	---

Switching action red (black) button pressed  
green (white) button pressed

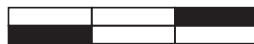

Switching element actuated

### 4 Keylock switch actuator 2 positions page 21 | Selector switch actuator 2 positions page 23 | Keylock switch actuator 2 positions, flush mounting page 33 | Selector switch actuator 2 positions, flush mounting page 35

Arrangement switching element corresponds to designation of front adaptor

1	3*	2
---	----	---

Switching action 90° O  
I

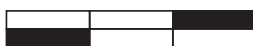

Switching element actuated

\* By using of not stackable switching elements, please cover the outside positions 1 and 2 of front adaptor

### 5 Keylock switch actuator 3 positions page 22 | Selector switch actuator 3 positions page 24 | Keylock switch actuator 3 positions, flush mounting page 34 | Selector switch actuator 3 positions, flush mounting page 36

Arrangement switching element corresponds to designation of front adaptor

1	3*	2
---	----	---

Switching function I  
O  
II 2 x 60°



Switching element actuated

\* By using of not stackable switching elements, please cover the outside positions 1 and 2 of front adaptor

## Mounting dimensions

1 Indicator full-face illumination complete page 6 | Indicator front illumination complete page 6 | Pushbutton complete page 7 | Illuminated pushbutton complete page 7 | Key lock switch 2 positions complete page 9 | Key lock switch 3 positions complete page 9 | Selector switch 2 positions complete page 10 | Selector switch 3 positions complete page 10 | Indicator actuator full-face illumination page 12 | Indicator actuator front illumination page 13 | Pushbutton actuator page 14 | Pushbutton actuator markable page 16 | Illuminated pushbutton actuator page 17 | Keylock switch actuator 2 positions page 21 | Keylock switch actuator 3 positions page 22 | Selector switch actuator 2 positions page 23 | Selector switch actuator 3 positions page 24 | Interlocking pushbutton actuator page 25 | Potentiometer-drive page 26 | Blind plug page 41

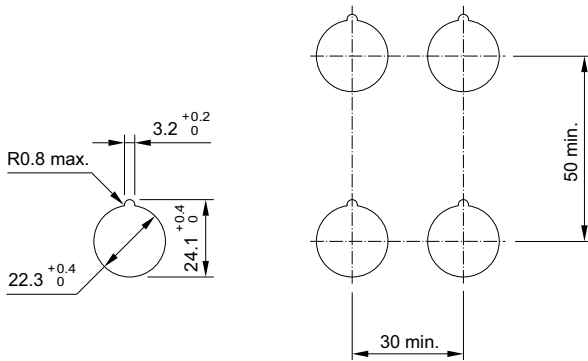

2 Emergency-stop pushbutton, foolproof EN IEC 60947-5-5, complete page 8 | Stop pushbutton, complete page 8 | Emergency-stop pushbutton actuator, foolproof EN IEC 60947-5-5 page 19 | Stop pushbutton actuator page 20 | Mushroom-head pushbutton actuator page 21

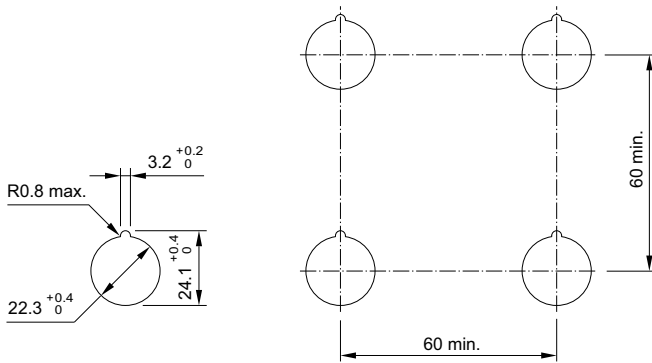

3 Double pushbutton actuator page 18

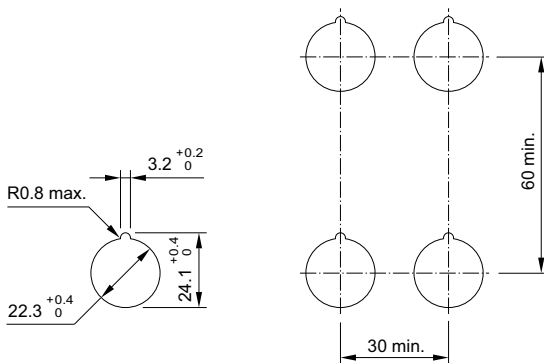

4 Control switch page 11

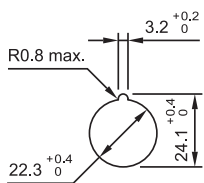

5 Indicator actuator full face illumination, flush mounting page 27 | Indicator actuator front illumination, flush mounting page 28 | Pushbutton actuator, flush mounting page 29 | Pushbutton actuator markable, flush mounting page 31 | Illuminated pushbutton actuator, flush mounting page 32 | Keylock switch actuator 2 positions, flush mounting page 33 | Keylock switch actuator 3 positions, flush mounting page 34 | Selector switch actuator 2 positions, flush mounting page 35 | Selector switch actuator 3 positions, flush mounting page 36 | Interlocking pushbutton actuator, flush mounting page 37 | Potentiometer-drive, flush mounting page 37

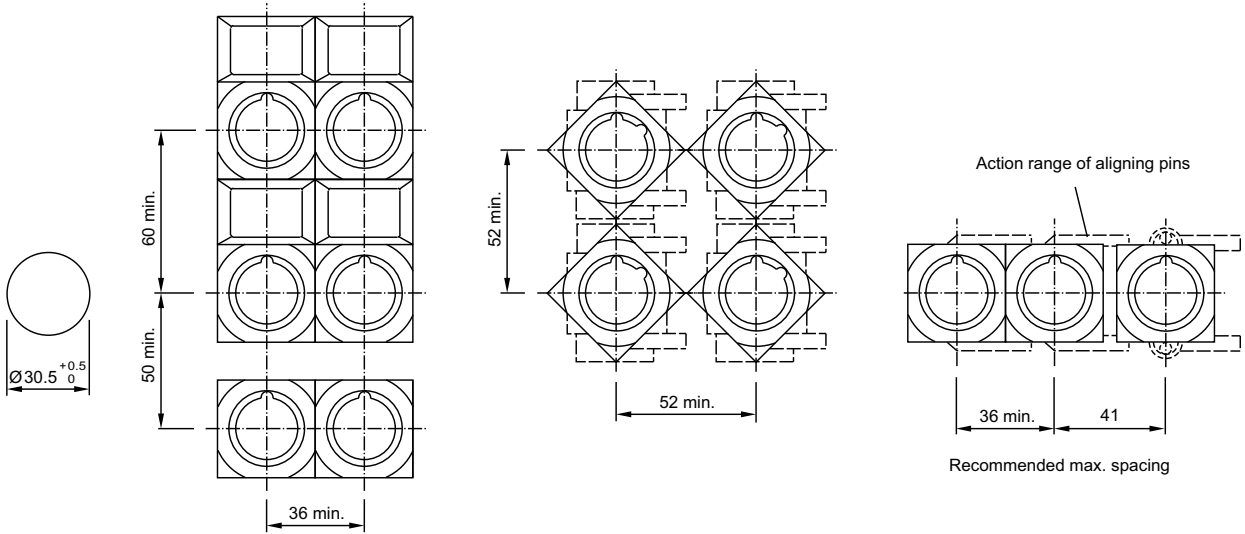

## Technical drawing

1 Potentiometer-drive, flush mounting page 37

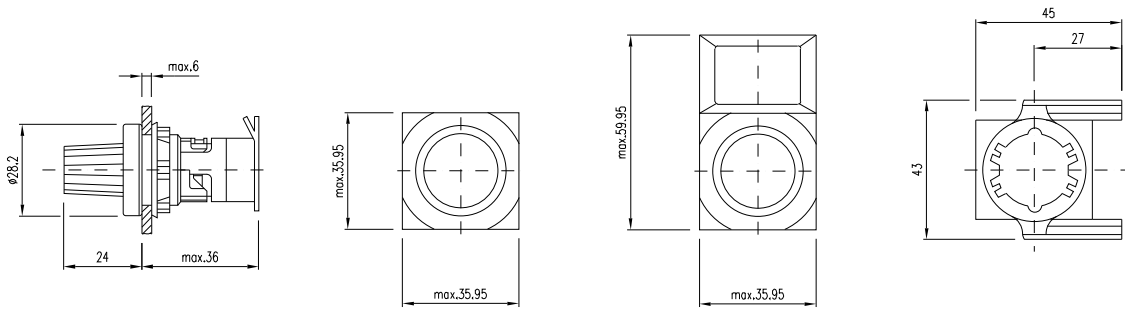

2 Front adapter, front mounting page 42

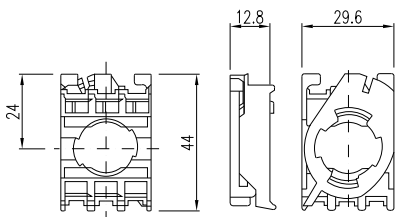

### 3 Resistor diode element page 46 | Diode element page 46

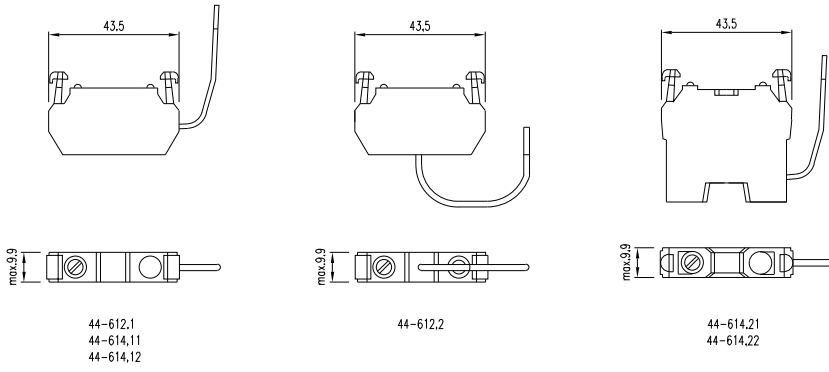

### 4 Lamp, base mounting page 44

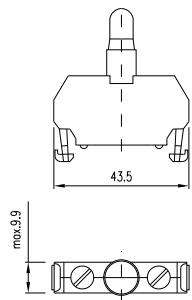

### 5 Blind plug page 41

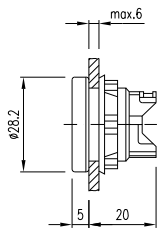

### 6 Blind element page 44

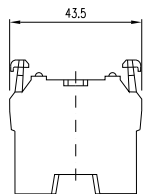

### 7 Label support without label page 39 | Label support with label page 40

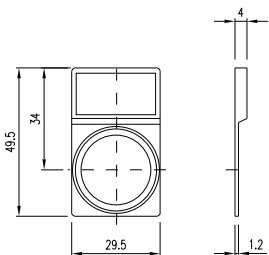

## 8 Legend plate page 39

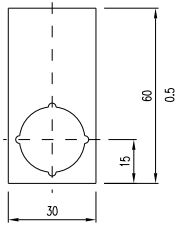

## 9 Protective cover page 40

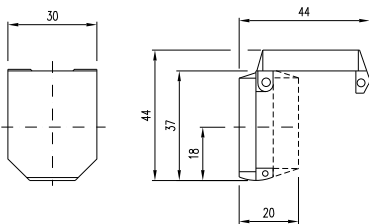

## 10 Control switch page 11

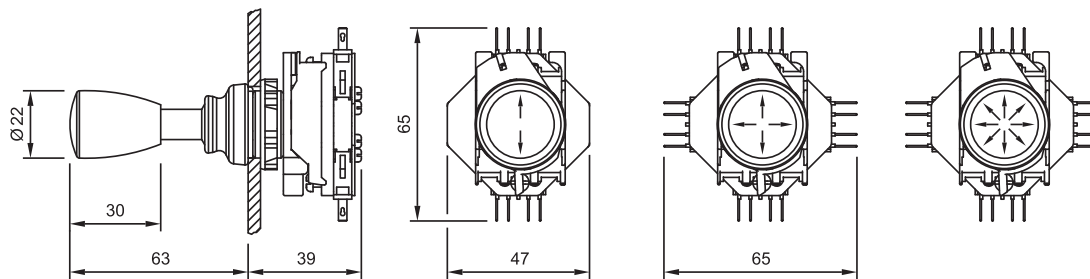

## 11 Pushbutton actuator, flush mounting page 29

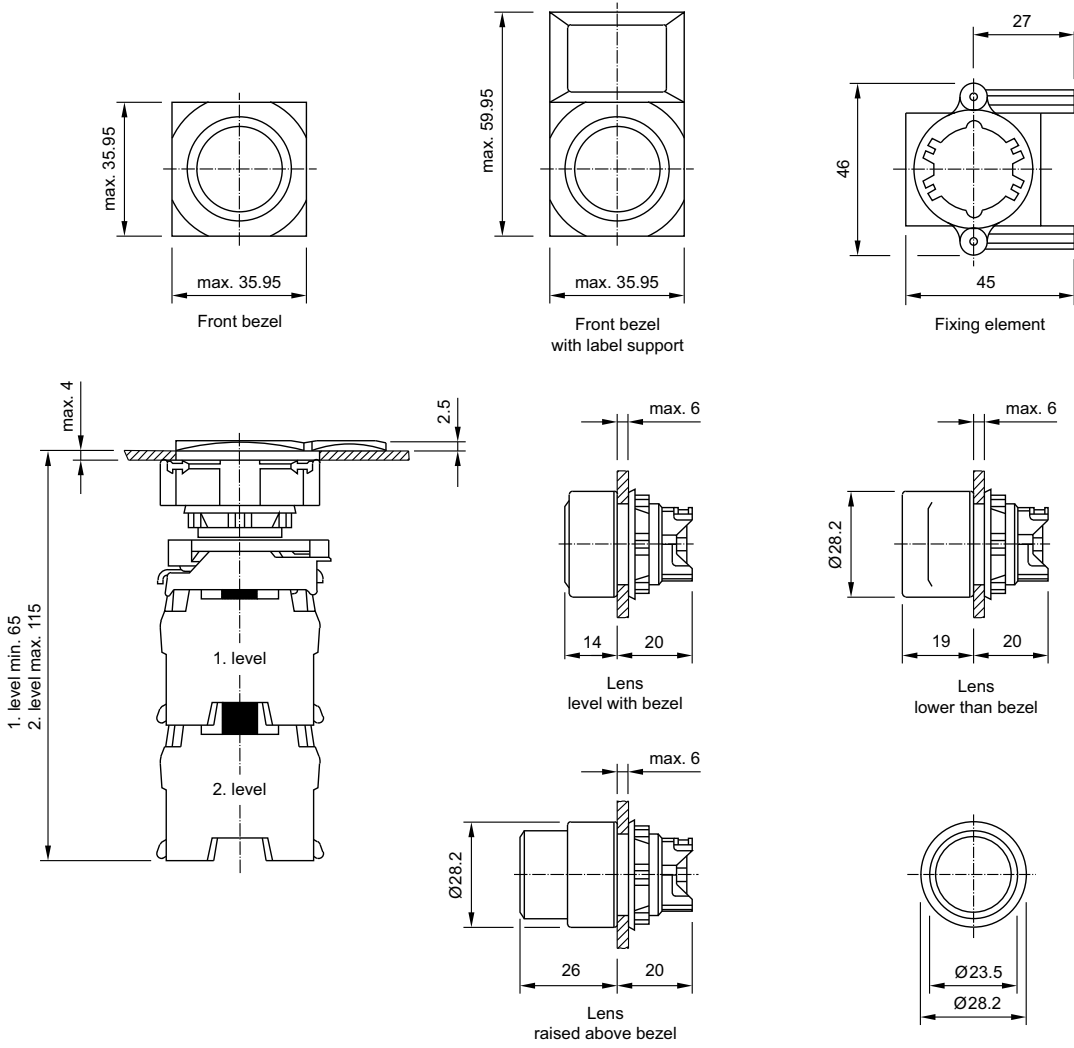



12 Indicator actuator full face illumination, flush mounting page 27 | Indicator actuator front illumination, flush mounting page 28

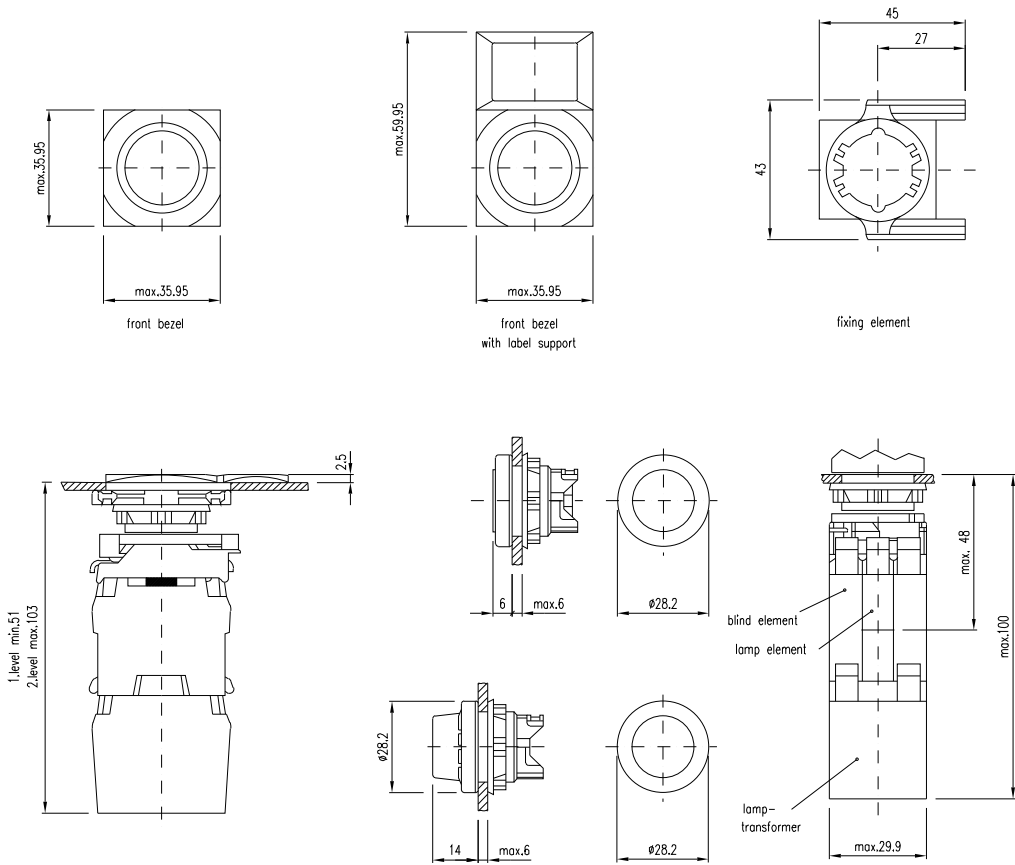

13 Indicator full-face illumination complete page 6 | Indicator front illumination complete page 6

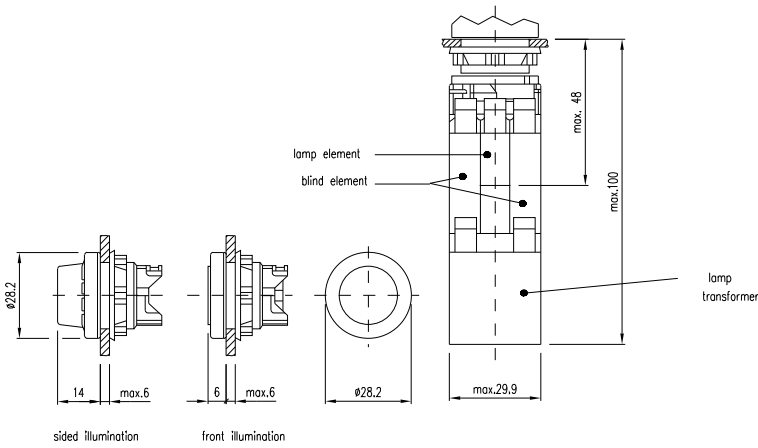

## 14 Pushbutton complete page 7

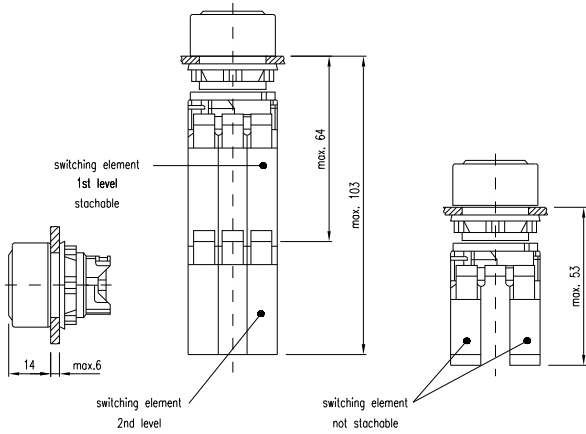

## 15 Illuminated pushbutton complete page 7

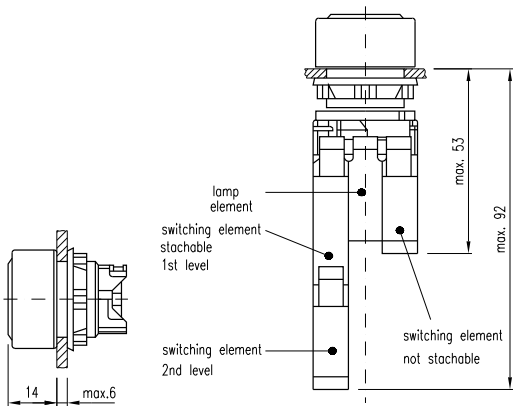

## 16 Selector switch 2 positions complete page 10

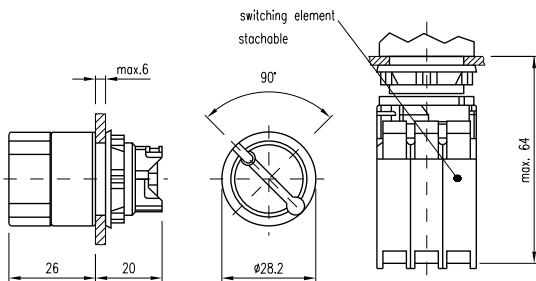

## 17 Selector switch 3 positions complete page 10

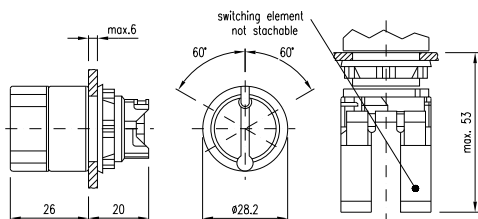

## 18 Key lock switch 2 positions complete page 9

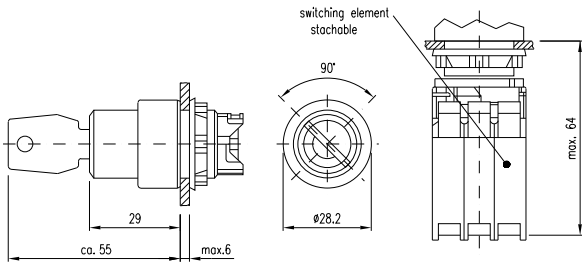

## 19 Indicator actuator full-face illumination page 12

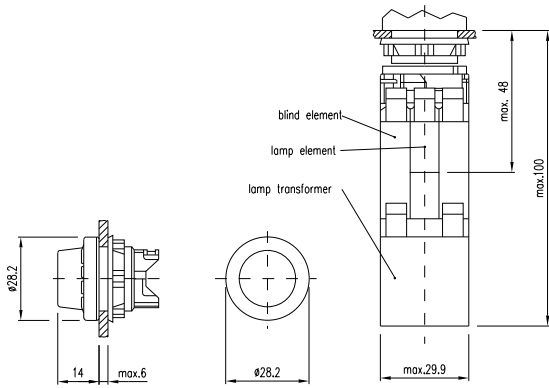

## 20 Pushbutton actuator page 14

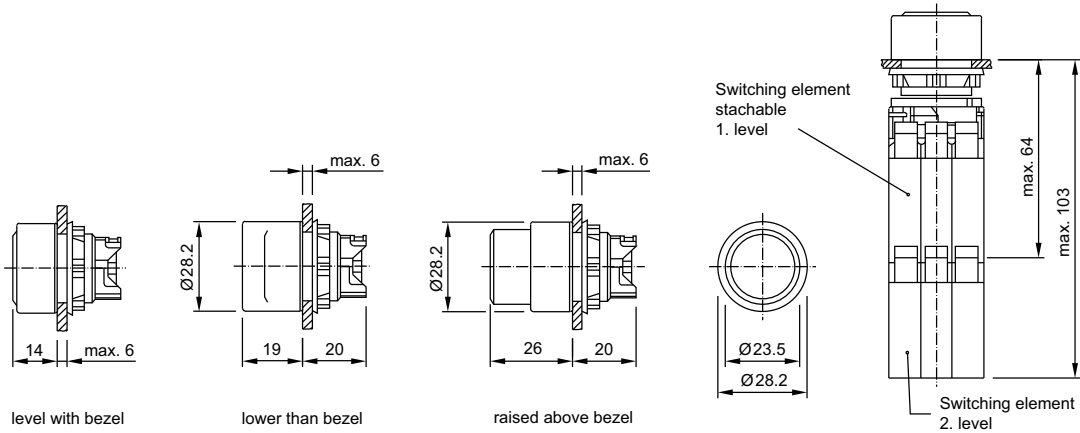

## 21 Selector switch actuator 2 positions page 23 | Selector switch actuator 3 positions page 24

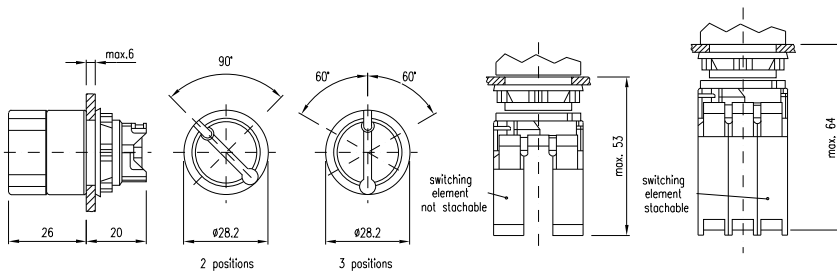

## 22 Indicator actuator front illumination page 13

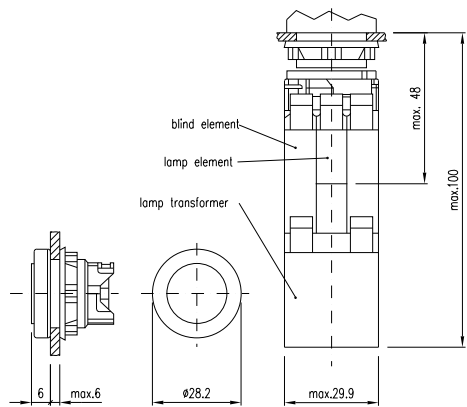

## 23 Pushbutton actuator markable page 16

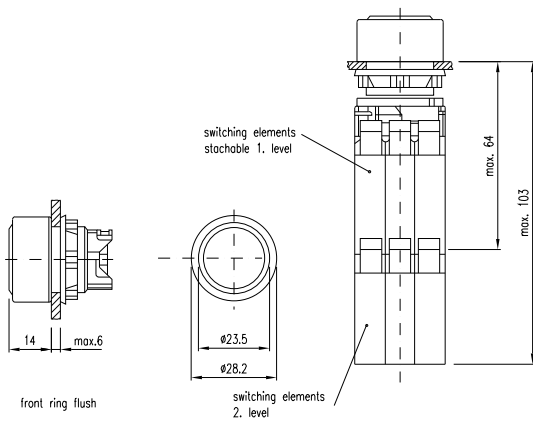

## 24 Illuminated pushbutton actuator page 17

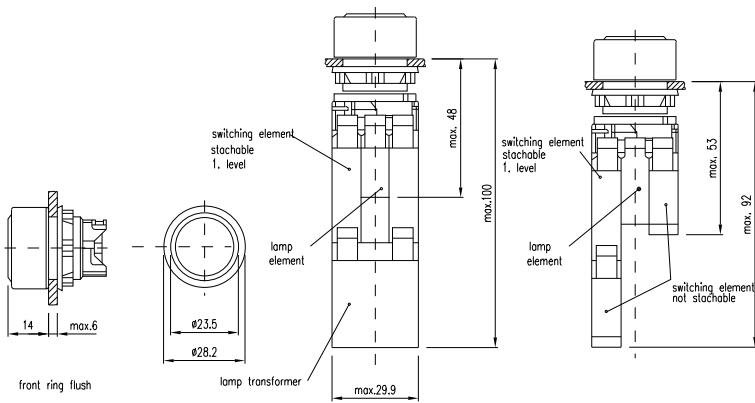

25 Pushbutton actuator markable, flush mounting page 31 | Illuminated pushbutton actuator, flush mounting page 32

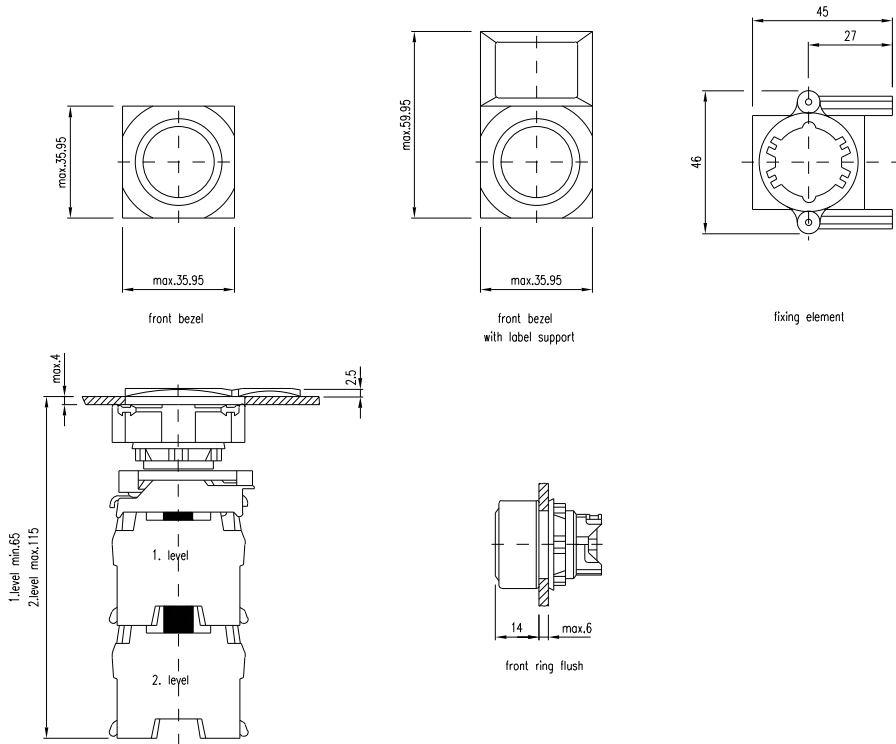

26 Selector switch actuator 2 positions, flush mounting page 35 | Selector switch actuator 3 positions, flush mounting page 36

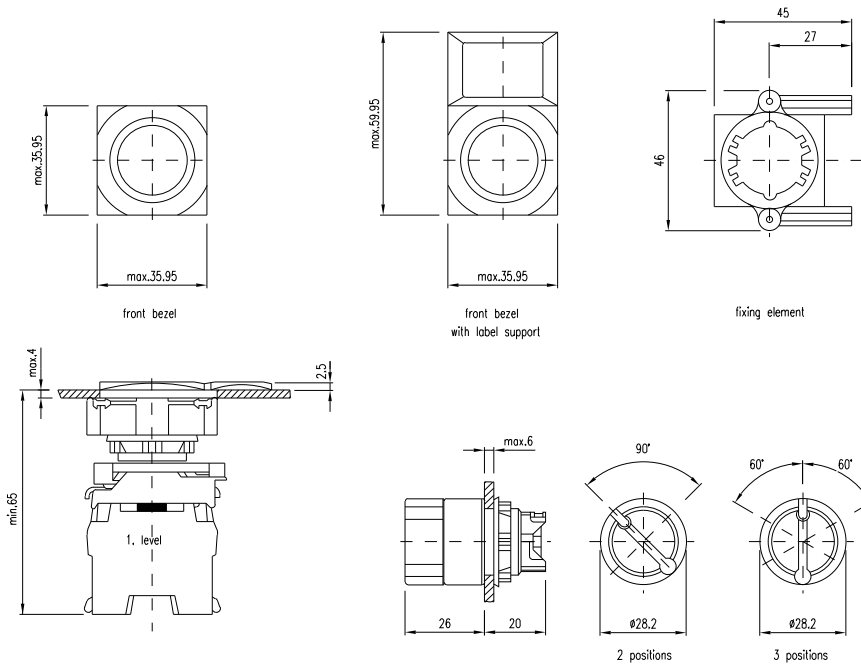

## 27 Key lock switch 3 positions complete page 9

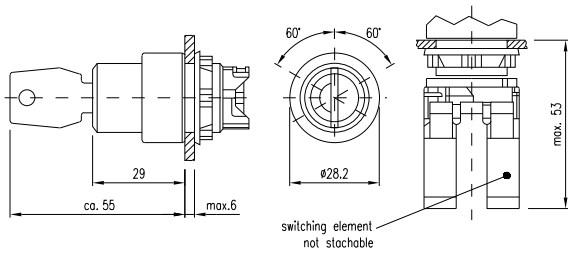

## 28 Stop pushbutton, complete page 8

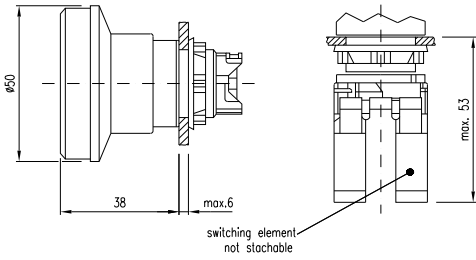

## 29 Emergency-stop pushbutton, foolproof EN IEC 60947-5-5, complete page 8

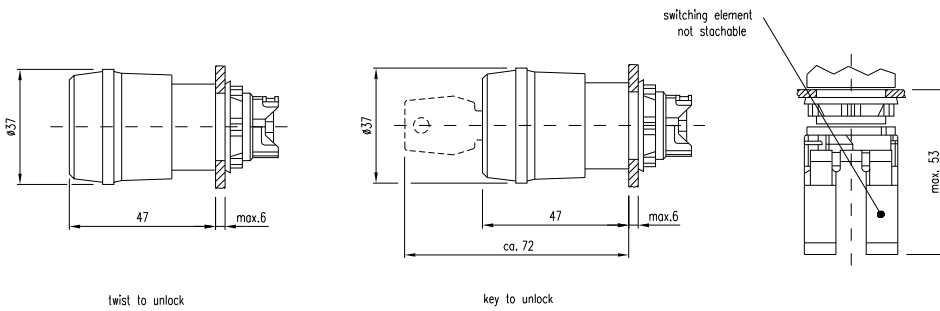

## 30 Keylock switch actuator 2 positions page 21 | Keylock switch actuator 3 positions page 22

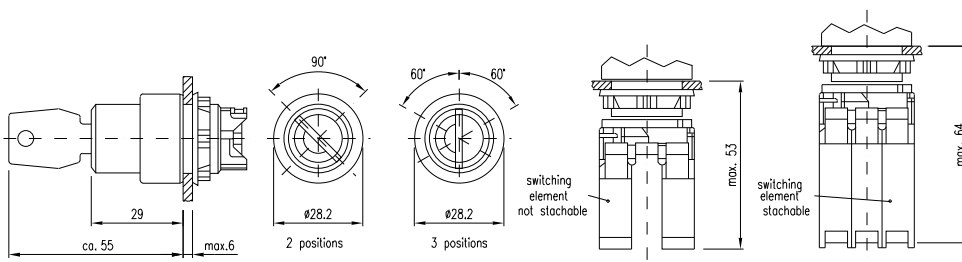

### 31 Mushroom-head pushbutton actuator page 21

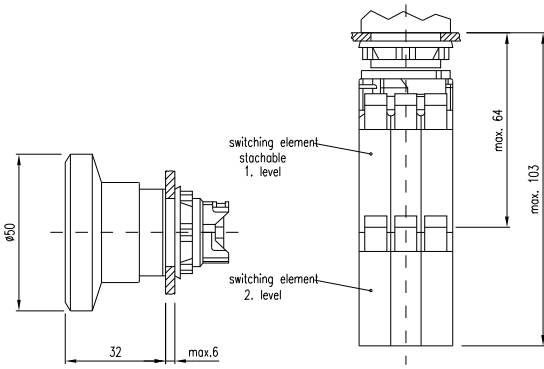

### 32 Emergency-stop pushbutton actuator, foolproof EN IEC 60947-5-5 page 19

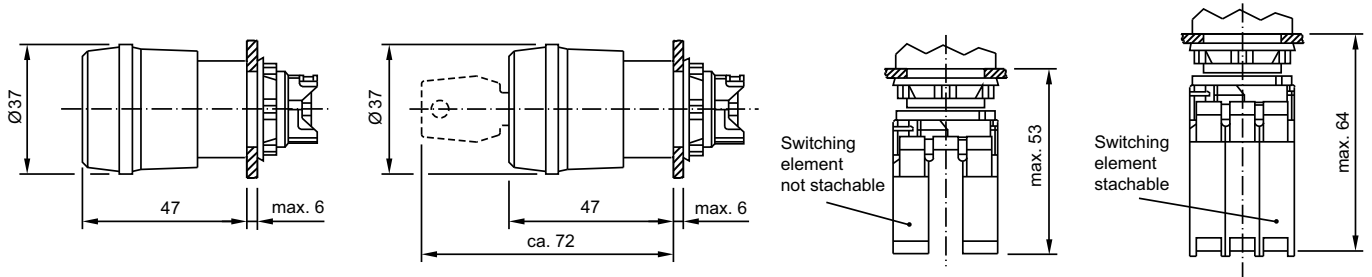

### 33 Stop pushbutton actuator page 20

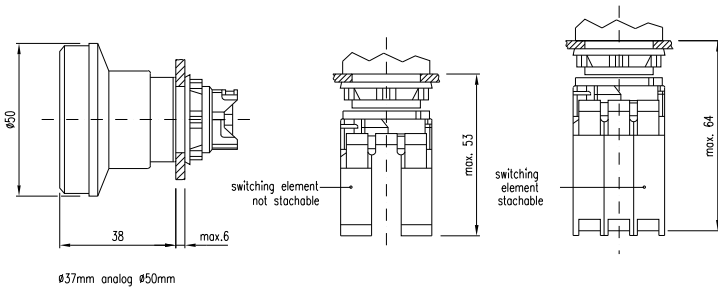

## 34 Keylock switch actuator 2 positions, flush mounting page 33 | Keylock switch actuator 3 positions, flush mounting page 34

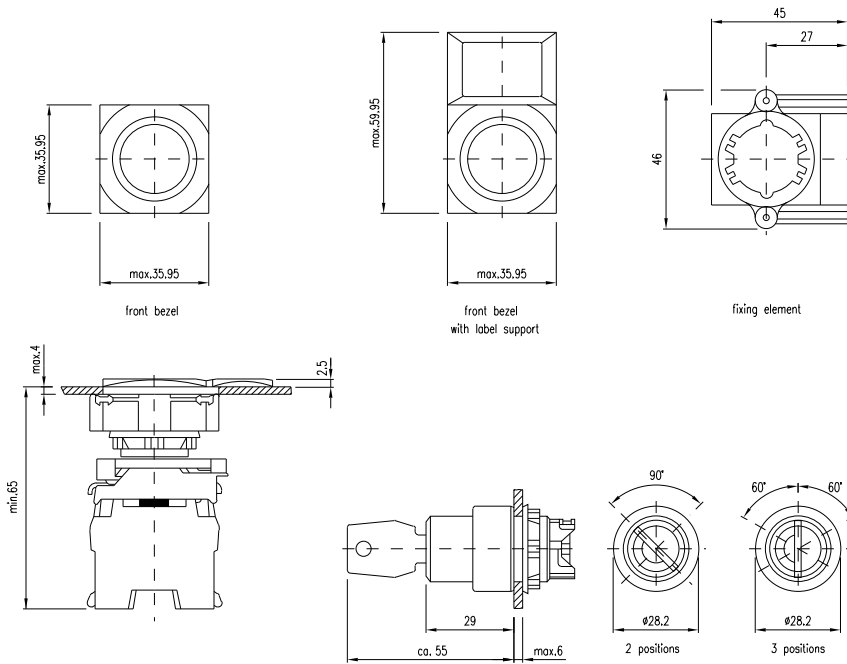

## 35 Interlocking pushbutton actuator page 25

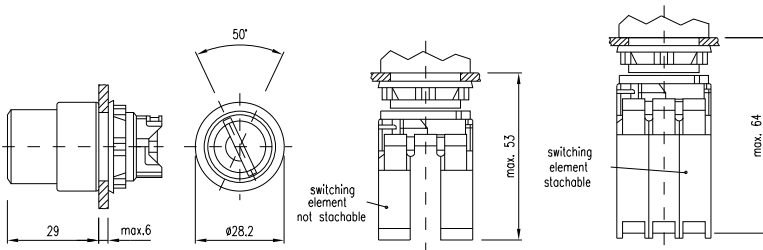

## 36 Double pushbutton actuator page 18

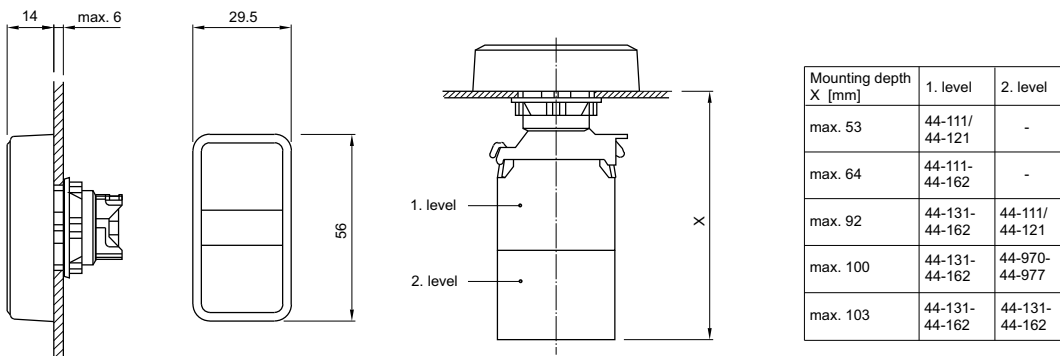



### 37 Potentiometer-drive page 26

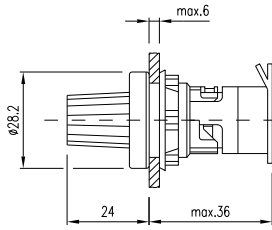

for potentiometer No. 47-745

### 38 Interlocking pushbutton actuator, flush mounting page 37

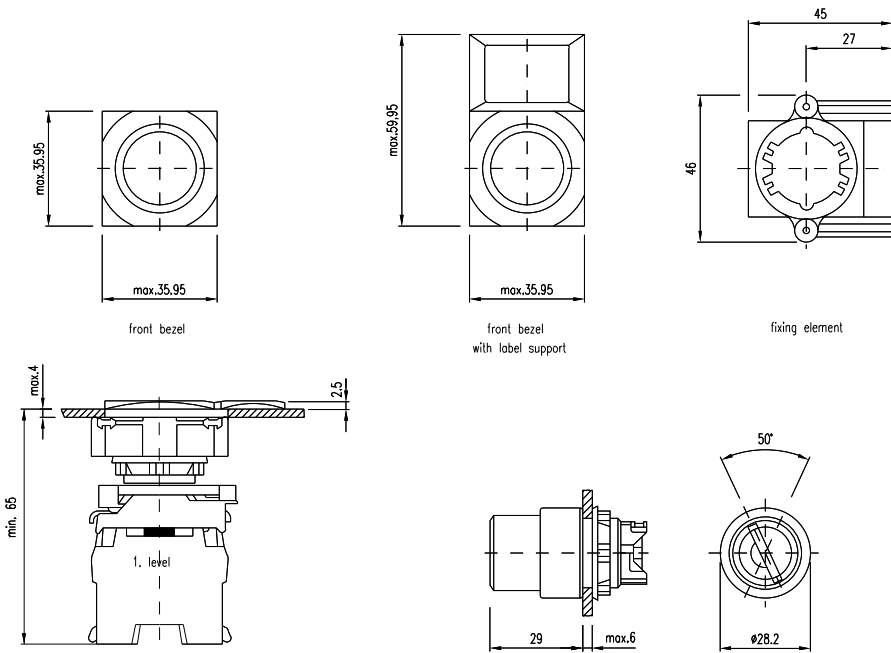

### 39 Slow-make switching element stackable, front mounting page 42 | Slow-make switching element non-stackable, front mounting page 43

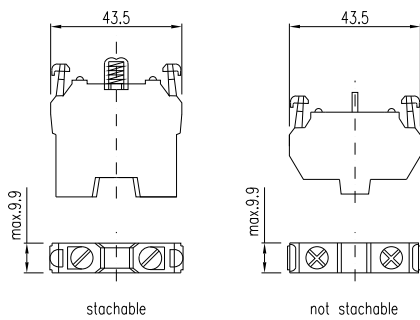

stackable

not stackable

## 40 Lamp element, front mounting page 43

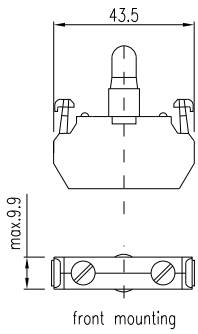

## 41 Slow-make switching element non-stackable, base mounting page 43

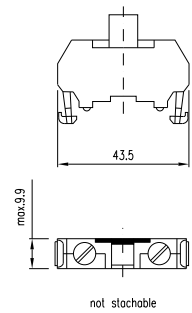

## 42 Lamp transformer page 46

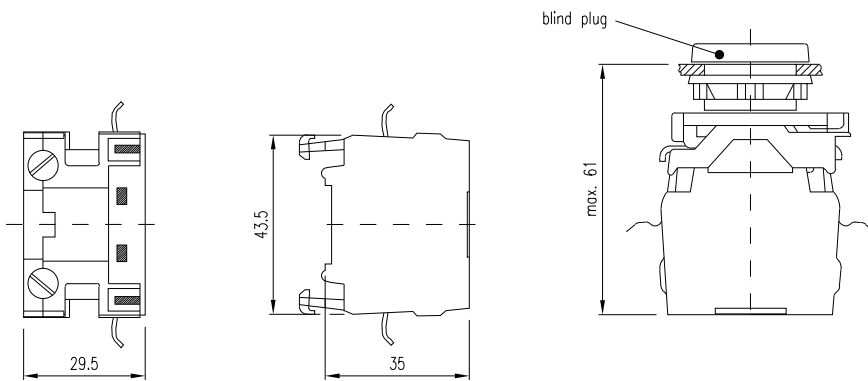

## 43 Front bezel set without label support, flush mounting page 38 | Front bezel set with label support, flush mounting page 39

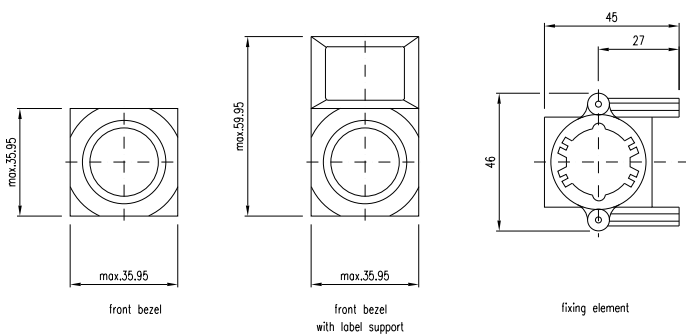

44 Emergency-stop enclosure page 19 | Stop pushbutton enclosure page 20 | Pushbutton enclosure page 25 | Emergency-stop enclosures page 48 | Enclosure page 48

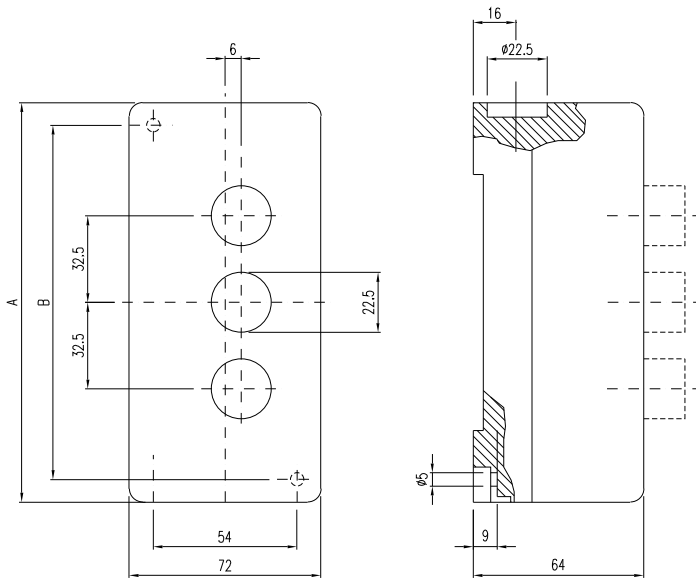

No. buttons	A	B
1	84	67
2	117	100
3	150	133
5	215	198

## Circuit drawing

1 Pushbutton actuator page 14 | Pushbutton actuator markable page 16 | Pushbutton actuator, flush mounting page 29 | Pushbutton actuator markable, flush mounting page 31



2 Pushbutton actuator page 14 | Pushbutton actuator markable page 16 | Mushroom-head pushbutton actuator page 21 | Pushbutton actuator, flush mounting page 29 | Pushbutton actuator markable, flush mounting page 31



3 Indicator full-face illumination complete page 6 | Indicator front illumination complete page 6 | Lamp element, front mounting page 43 | Lamp, base mounting page 44

x1+



x2-

4 Potentiometer-drive page 26 | Potentiometer-drive, flush mounting page 37

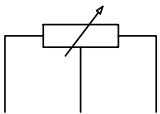

5 Emergency-stop pushbutton actuator, foolproof EN IEC 60947-5-5 page 19 | Stop pushbutton actuator page 20



6 Illuminated pushbutton actuator page 17 | Illuminated pushbutton actuator, flush mounting page 32

x1+



x2-

**7 Pushbutton complete** page 7

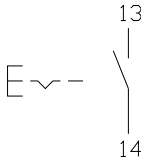

**8 Illuminated pushbutton complete** page 7

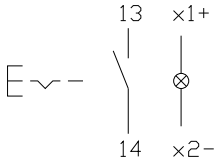

**9 Pushbutton complete** page 7

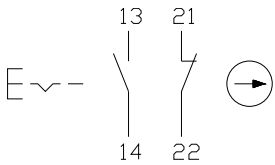

**10 Illuminated pushbutton complete** page 7

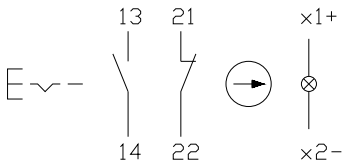

**11 Selector switch actuator 2 positions** page 23 | **Selector switch actuator 2 positions, flush mounting** page 35

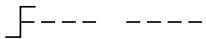

**12 Selector switch actuator 3 positions** page 24 | **Selector switch actuator 3 positions, flush mounting** page 36

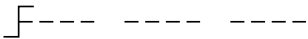

**13 Selector switch actuator 3 positions** page 24 | **Selector switch actuator 3 positions, flush mounting** page 36

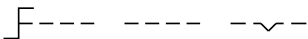

**14 Selector switch actuator 2 positions** page 23 | **Selector switch actuator 2 positions, flush mounting** page 35

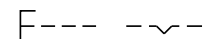

**15 Selector switch actuator 3 positions** page 24 | **Selector switch actuator 3 positions, flush mounting** page 36

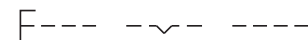

**16 Selector switch actuator 3 positions** page 24 | **Selector switch actuator 3 positions, flush mounting** page 36

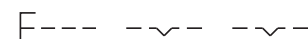

**17 Selector switch 2 positions complete** page 10

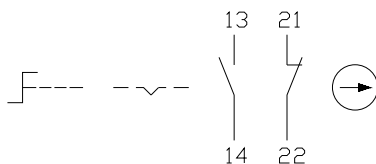

**18 Selector switch 3 positions complete** page 10

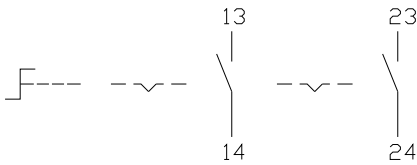

**19 Interlocking pushbutton actuator** page 25 | **Interlocking pushbutton actuator, flush mounting** page 37

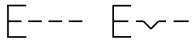

**20 Illuminated pushbutton actuator** page 17 | **Illuminated pushbutton actuator, flush mounting** page 32

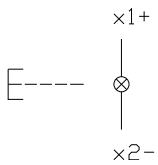

**21 Pushbutton complete** page 7

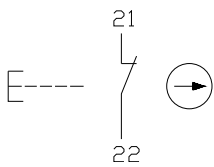

**22 Illuminated pushbutton complete** page 7

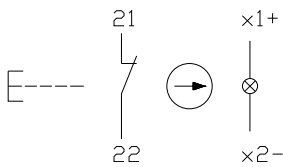

**23 Pushbutton complete** page 7

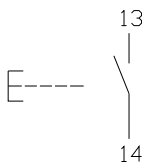

**24 Illuminated pushbutton complete** page 7

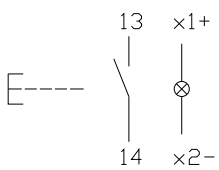

**25 Pushbutton complete** page 7

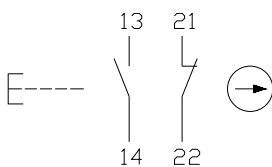

**26 Illuminated pushbutton complete** page 7

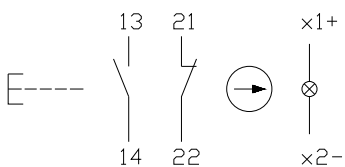

27 Keylock switch actuator 2 positions page 21 | Keylock switch actuator 2 positions, flush mounting page 33

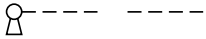

28 Keylock switch actuator 3 positions page 22 | Keylock switch actuator 3 positions, flush mounting page 34

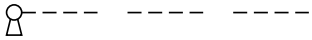

29 Keylock switch actuator 3 positions page 22 | Keylock switch actuator 3 positions, flush mounting page 34

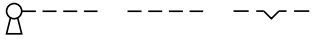

30 Keylock switch actuator 2 positions page 21 | Keylock switch actuator 2 positions, flush mounting page 33

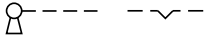

31 Keylock switch actuator 3 positions page 22 | Keylock switch actuator 3 positions, flush mounting page 34



32 Keylock switch actuator 3 positions page 22 | Keylock switch actuator 3 positions, flush mounting page 34



33 Key lock switch 2 positions complete page 9

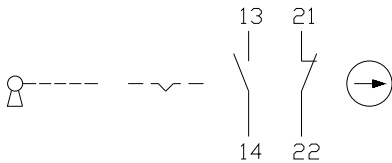

34 Key lock switch 3 positions complete page 9

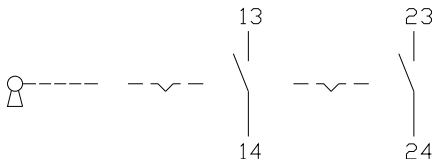

35 Slow-make switching element stackable, front mounting page 42

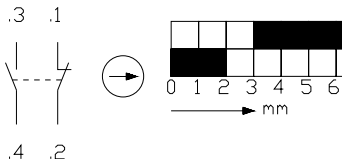

36 Slow-make switching element stackable, front mounting page 42

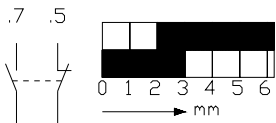

8 .6 for slow-make switching element Typ-Nr. 44-141

37 Emergency-stop pushbutton, foolproof EN IEC 60947-5-5, complete page 8 | Stop pushbutton, complete page 8

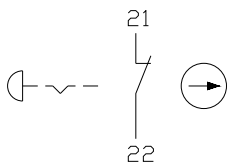

**38 Slow-make switching element stackable, front mounting** page 42 | **Slow-make switching element non-stackable, front mounting** page 43 | **Slow-make switching element non-stackable, base mounting** page 43

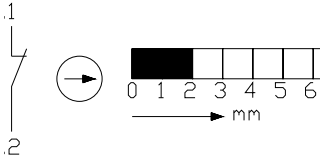

**39 Slow-make switching element stackable, front mounting** page 42 | **Slow-make switching element non-stackable, front mounting** page 43 | **Slow-make switching element non-stackable, base mounting** page 43

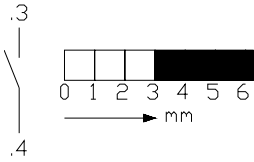

**40 Control switch** page 11

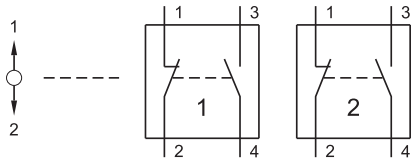

**41 Control switch** page 11

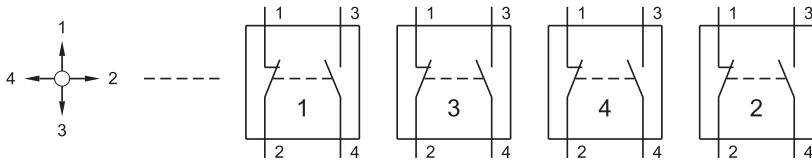

**42 Control switch** page 11

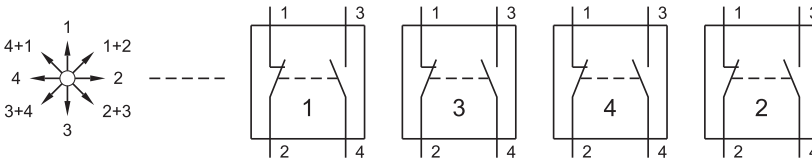

# Index from Typ-Nr.

Typ-Nr.	Page	Typ-Nr.	Page	Typ-Nr.	Page
10-1406.1369	44	44-221	43	44-702.64	30
10-1409.1329	44	44-524	43	44-702.65	15
10-1412.1279	44	44-525	44	44-702.65	30
10-1416.1289	44	44-612.1	46	44-702.66	15
10-1419.1249	44	44-612.2	46	44-702.66	30
10-1420.1219	44	44-614.11	46	44-702.67	16
10-1422.1179	44	44-614.12	46	44-702.67	31
10-1424.1179	44	44-614.21	46	44-702.69	15
10-2506.1082	45	44-614.22	46	44-702.69	30
10-2506.1084	45	44-701.20	14	44-703.20	14
10-2506.1085	45	44-701.20	29	44-703.20	29
10-2506.1086	45	44-701.20.100	7	44-703.22	14
10-2506.1089	45	44-701.22	14	44-703.22	29
10-2509.1142	45	44-701.22	29	44-703.24	14
10-2509.1144	45	44-701.22.001	7	44-703.24	29
10-2509.1145	45	44-701.24	14	44-703.25	14
10-2509.1146	45	44-701.24	29	44-703.25	29
10-2509.1149	45	44-701.24.010	7	44-703.26	14
10-2512.1142	45	44-701.25	14	44-703.26	29
10-2512.1144	45	44-701.25	29	44-703.29	14
10-2512.1145	45	44-701.25.010	7	44-703.29	29
10-2512.1146	45	44-701.26	14	44-703.60	14
10-2512.1149	45	44-701.26	29	44-703.60	29
10-2513.1142	45	44-701.27	16	44-703.62	14
10-2513.1144	45	44-701.27	31	44-703.62	29
10-2513.1145	45	44-701.29	14	44-703.64	14
10-2513.1146	45	44-701.29	29	44-703.64	29
10-2513.1149	45	44-701.29.010	7	44-703.65	14
10-2519.1052	45	44-701.60	14	44-703.65	29
10-2519.1054	45	44-701.60	29	44-703.66	14
10-2519.1055	45	44-701.62	14	44-703.66	29
10-2519.1056	45	44-701.62	29	44-703.69	14
10-2519.1059	45	44-701.64	14	44-703.69	29
10-2H24.2052	45	44-701.64	29	44-704.20	14
10-2H24.2054	45	44-701.65	14	44-704.20	29
10-2H24.2055	45	44-701.65	29	44-704.22	14
10-2H24.2056	45	44-701.66	14	44-704.22	29
10-2H24.2059	45	44-701.66	29	44-704.24	14
10-2H25.2042	45	44-701.67	16	44-704.24	29
10-2H25.2044	45	44-701.67	31	44-704.25	14
10-2H25.2045	45	44-701.69	14	44-704.25	29
10-2H25.2046	45	44-701.69	29	44-704.26	14
10-2H25.2049	45	44-702.20	15	44-704.26	29
44-001.4	48	44-702.20	30	44-704.29	14
44-001.4-03	20	44-702.20.100	7	44-704.29	29
44-001.4-05	19	44-702.22	15	44-704.60	14
44-001.8	48	44-702.22	30	44-704.60	29
44-001.8-01	25	44-702.24	15	44-704.62	14
44-001.8-02	25	44-702.24	30	44-704.62	29
44-002.8	48	44-702.25	15	44-704.64	14
44-002.8-04	25	44-702.25	30	44-704.64	29
44-003.8	48	44-702.25.010	7	44-704.65	14
44-005.8	48	44-702.26	15	44-704.65	29
44-111	43	44-702.26	30	44-704.66	14
44-121	43	44-702.27	16	44-704.66	29
44-131	42	44-702.27	31	44-704.69	14
44-132	42	44-702.29	15	44-704.69	29
44-141	42	44-702.29	30	44-705.20	15
44-151	42	44-702.60	15	44-705.20	30
44-152	42	44-702.60	30	44-705.22	15
44-161	42	44-702.62	15	44-705.22	30
44-162	42	44-702.62	30	44-705.24	15
44-211	43	44-702.64	15	44-705.24	30



# Index from Typ-Nr.

Typ-Nr.	Page	Typ-Nr.	Page	Typ-Nr.	Page
44-705.25	15	44-720.68	35	44-736.63	22
44-705.25	30	44-722.20	23	44-736.63	34
44-705.26	15	44-722.20	35	44-737.21	22
44-705.26	30	44-722.68	23	44-737.21	34
44-705.29	15	44-722.68	35	44-737.24	22
44-705.29	30	44-724.20	24	44-737.24	34
44-705.60	15	44-724.20	36	44-737.61	22
44-705.60	30	44-724.20.020	10	44-737.61	34
44-705.62	15	44-724.68	24	44-737.64	22
44-705.62	30	44-724.68	36	44-737.64	34
44-705.64	15	44-725.20	24	44-742.20	25
44-705.64	30	44-725.20	36	44-742.20	37
44-705.65	15	44-725.68	24	44-742.22	25
44-705.65	30	44-725.68	36	44-742.22	37
44-705.66	15	44-726.20	24	44-742.62	25
44-705.66	30	44-726.20	36	44-742.62	37
44-705.69	15	44-726.68	24	44-742.68	25
44-705.69	30	44-726.68	36	44-742.68	37
44-706.20	15	44-727.20	24	44-744.20	26
44-706.20	30	44-727.20	36	44-744.20	37
44-706.22	15	44-727.68	24	44-744.60	26
44-706.22	30	44-727.68	36	44-744.60	37
44-706.24	15	44-730.21	21	44-745.20-10K1	26
44-706.24	30	44-730.21	33	44-745.20-10K1	37
44-706.25	15	44-730.21.100	9	44-745.60-10K1	26
44-706.25	30	44-730.22	21	44-745.60-10K1	37
44-706.26	15	44-730.22	33	44-746.22	17
44-706.26	30	44-730.22.100	9	44-746.22	32
44-706.29	15	44-730.61	21	44-746.22.001	7
44-706.29	30	44-730.61	33	44-746.24	17
44-706.60	15	44-730.62	21	44-746.24	32
44-706.60	30	44-730.62	33	44-746.24.010	7
44-706.62	15	44-732.21	21	44-746.25	17
44-706.62	30	44-732.21	33	44-746.25	32
44-706.64	15	44-732.61	21	44-746.25.010	7
44-706.64	30	44-732.61	33	44-746.26	17
44-706.65	15	44-734.21	22	44-746.26	32
44-706.65	30	44-734.21	34	44-746.29	17
44-706.66	15	44-734.23	22	44-746.29	32
44-706.66	30	44-734.23	34	44-746.29.100	7
44-706.69	15	44-734.24	22	44-746.62	17
44-706.69	30	44-734.24	34	44-746.62	32
44-707.20	21	44-734.25	22	44-746.64	17
44-707.22	21	44-734.25	34	44-746.64	32
44-707.25	21	44-734.25.020	9	44-746.65	17
44-707.60	21	44-734.61	22	44-746.65	32
44-707.62	21	44-734.61	34	44-746.66	17
44-707.65	21	44-734.63	22	44-746.66	32
44-710	20	44-734.63	34	44-746.69	17
44-710.001	8	44-734.64	22	44-746.69	32
44-711	20	44-734.64	34	44-747.22	17
44-712	19	44-734.65	22	44-747.22	32
44-712.001	8	44-734.65	34	44-747.24	17
44-713	19	44-735.21	22	44-747.24	32
44-713.001	8	44-735.21	34	44-747.25	17
44-720.20	23	44-735.61	22	44-747.25	32
44-720.20	35	44-735.61	34	44-747.25.010	7
44-720.20.100	10	44-736.21	22	44-747.26	17
44-720.22	23	44-736.21	34	44-747.26	32
44-720.22	35	44-736.23	22	44-747.29	17
44-720.62	23	44-736.23	34	44-747.29	32
44-720.62	35	44-736.61	22	44-747.29.100	7
44-720.68	23	44-736.61	34	44-747.62	17

# Index from Typ-Nr.

Typ-Nr.	Page	Typ-Nr.	Page	Typ-Nr.	Page
44-747.62	32	44-774.2	18	44-961.6	38
44-747.64	17	44-774.6	18	44-962.9	38
44-747.64	32	44-800.2	11	44-963	48
44-747.65	17	44-800.4	11	44-965.2	38
44-747.65	32	44-800.8	11	44-965.4	38
44-747.66	17	44-900	42	44-965.5	38
44-747.66	32	44-901	42	44-965.6	38
44-747.69	17	44-902	42	44-965.7	38
44-747.69	32	44-903	42	44-966.2	38
44-750.22	12	44-905	43	44-966.4	38
44-750.22	27	44-915	41	44-966.5	38
44-750.22.000	6	44-917.07	41	44-966.6	38
44-750.24	12	44-919	41	44-966.7	38
44-750.24	27	44-921.00	41	44-967.2	40
44-750.24.000	6	44-921.08	41	44-967.6	40
44-750.25	12	44-922	40	44-968.2	40
44-750.25	27	44-925	49	44-968.6	40
44-750.25.000	6	44-935	49	44-970	46
44-750.26	12	44-940	44	44-971	46
44-750.26	27	44-944.00	39	44-972	46
44-750.27	12	44-944.08	39	44-975	46
44-750.27	27	44-945.00	40	44-976	46
44-750.27.000	6	44-945.08	40	44-977	46
44-750.62	12	44-946	39		
44-750.62	27	44-946.0	39		
44-750.64	12	44-946.01	38		
44-750.64	27	44-946.01-A	38		
44-750.65	12	44-946.02	39		
44-750.65	27	44-946.03	38		
44-750.66	12	44-946.03-A	38		
44-750.66	27	44-946.04	39		
44-750.67	12	44-949	47		
44-750.67	27	44-949.1	47		
44-751.22	13	44-949.2	47		
44-751.22	28	44-949.3	47		
44-751.22.000	6	44-949.4	47		
44-751.24	13	44-950	47		
44-751.24	28	44-950.1	47		
44-751.24.000	6	44-950.2	47		
44-751.25	13	44-950.3	47		
44-751.25	28	44-950.4	47		
44-751.25.000	6	44-951	47		
44-751.26	13	44-951.1	47		
44-751.26	28	44-951.2	47		
44-751.29	13	44-951.3	47		
44-751.29	28	44-951.4	47		
44-751.29.000	6	44-955	39		
44-751.62	13	44-956	48		
44-751.62	28	44-956	49		
44-751.64	13	44-957.010	47		
44-751.64	28	44-957.020	47		
44-751.65	13	44-957.030	47		
44-751.65	28	44-957.050	47		
44-751.66	13	44-957.060	47		
44-751.66	28	44-959.05	47		
44-751.69	13	44-959.10	47		
44-751.69	28	44-959.15	47		
44-770.2	18	44-959.20	47		
44-770.6	18	44-960	40		
44-771.2	18	44-961.0	38		
44-771.6	18	44-961.2	38		
44-773.2	18	44-961.4	38		
44-773.6	18	44-961.5	38		



	<b>EAO AG</b>
	Tannwaldstrasse 88 4601 Olten, Switzerland
<b>E-mail</b>	info@eao.com
<b>Website</b>	www.eao.com
	<b>Austria</b>
Phone	+49 201 85 87 0
Fax	+49 201 85 87 210
E-mail	sales.ede@eao.com
	<b>Belgium</b>
Phone	+32 3 777 82 36
Fax	+32 3 777 84 19
E-mail	sales.ebl@eao.com
	<b>China</b>
Phone	+852 27 86 91 41
Fax	+852 27 86 95 61
E-mail	sales.ehk@eao.com
	<b>France</b>
Phone	+33 1 64 43 37 37
Fax	+33 1 64 43 37 49
E-mail	sales.esa@eao.com
	<b>Germany</b>
Phone	+49 201 85 87 0
Fax	+49 201 85 87 210
E-mail	sales.ede@eao.com
	<b>Italy</b>
Phone	+39 035 481 0189
Fax	+39 035 481 3786
E-mail	sales.eit@eao.com
	<b>Japan</b>
Phone	+81 3 5444 5411
Fax	+81 3 5444 0345
E-mail	sales.esj@eao.com
	<b>Netherlands</b>
Phone	+31 78 653 17 00
Fax	+31 78 653 17 99
E-mail	sales.enl@eao.com
	<b>Sweden</b>
Phone	+46 8 683 86 60
Fax	+46 8 724 29 12
E-mail	sales.esw@eao.com
	<b>Switzerland</b>
Phone	+41 62 388 95 00
Fax	+41 62 388 95 55
E-mail	sales.ech@eao.com
	<b>United Kingdom</b>
Phone	+44 1444 236 000
Fax	+44 1444 236 641
E-mail	sales.euk@eao.com
	<b>USA</b>
Phone	+1 203 877 4577
Fax	+1 203 877 3694
E-mail	sales.eus@eao.com
	<b>Other Countries</b>
Phone	+41 62 286 92 10
Fax	+41 62 296 21 62
E-mail	info@eao.com



Компания «ЭлектроПласт» предлагает заключение долгосрочных отношений при поставках импортных электронных компонентов на взаимовыгодных условиях!

Наши преимущества:

- Оперативные поставки широкого спектра электронных компонентов отечественного и импортного производства напрямую от производителей и с крупнейших мировых складов;
- Поставка более 17-ти миллионов наименований электронных компонентов;
- Поставка сложных, дефицитных, либо снятых с производства позиций;
- Оперативные сроки поставки под заказ (от 5 рабочих дней);
- Экспресс доставка в любую точку России;
- Техническая поддержка проекта, помощь в подборе аналогов, поставка прототипов;
- Система менеджмента качества сертифицирована по Международному стандарту ISO 9001;
- Лицензия ФСБ на осуществление работ с использованием сведений, составляющих государственную тайну;
- Поставка специализированных компонентов (Xilinx, Altera, Analog Devices, Intersil, Interpoint, Microsemi, Aeroflex, Peregrine, Syfer, Eurofarad, Texas Instrument, Miteq, Cobham, E2V, MA-COM, Hittite, Mini-Circuits, General Dynamics и др.);

Помимо этого, одним из направлений компании «ЭлектроПласт» является направление «Источники питания». Мы предлагаем Вам помощь Конструкторского отдела:

- Подбор оптимального решения, техническое обоснование при выборе компонента;
- Подбор аналогов;
- Консультации по применению компонента;
- Поставка образцов и прототипов;
- Техническая поддержка проекта;
- Защита от снятия компонента с производства.



#### Как с нами связаться

**Телефон:** 8 (812) 309 58 32 (многоканальный)

**Факс:** 8 (812) 320-02-42

**Электронная почта:** [org@eplast1.ru](mailto:org@eplast1.ru)

**Адрес:** 198099, г. Санкт-Петербург, ул. Калинина, дом 2, корпус 4, литера А.