



FEATURES

- The smallest, full-featured triples
- Low cost! Highly reliable!
- Proven SMT-on-pcb construction
- Qual tested; HALT tested; EMC tested
- Output voltages: +5V/±12V or +5V/±15V
- Four input voltage ranges:
- 4.7-7V, 9-18V, 18-36V or 36-72V
- Small packages, 2" x 1" x 0.375"
- -40 to +100°C operating temperature
- Fully isolated, 1500Vdc guaranteed
- Guaranteed efficiencies to 82%
- Designed to meet UL1950 and EN60950
- Modifications and customs for OEM's

PRODUCT OVERVIEW

Among the three families of triple-output DC/DC converters in DATEL's new A-Series, the 8-11W, 2" x 1" devices stand out as the industry's smallest full-featured triples. Housed in miniature 2" x 1" x 0.375", 5-side shielded, metal packages with electrically non-conductive coatings, these power converters offer non-latching output current limiting, input overvoltage shutdown (except D5A models), input reverse-polarity protection, and output overvoltage clamping to protect both the power converters and their loads.

As members of DATEL's new A-Series, the 8-11W triples feature both low cost and outstanding long-term reliability. Their design combines straightforward circuit topologies, the newest components, proven SMT-on-pcb construction

methods, and highly repeatable automatic-assembly techniques. Their superior durability is substantiated by a rigorous in-house qualification program that includes HALT (Highly Accelerated Life Testing).

Each of these fully line and load-regulated switching DC/DC converters has a +5V primary output (with output current as high as 1A) and either ±12V or ±15V auxiliary outputs (with currents as high as ±210mA). These devices were designed to power small analog/digital partitions in equipment employing distributed-power architectures with bus voltages between 4.7 and 72 Volts. Applications include computer/networking, telecom/datacom equipment, industrial instrumentation and automatic test equipment.

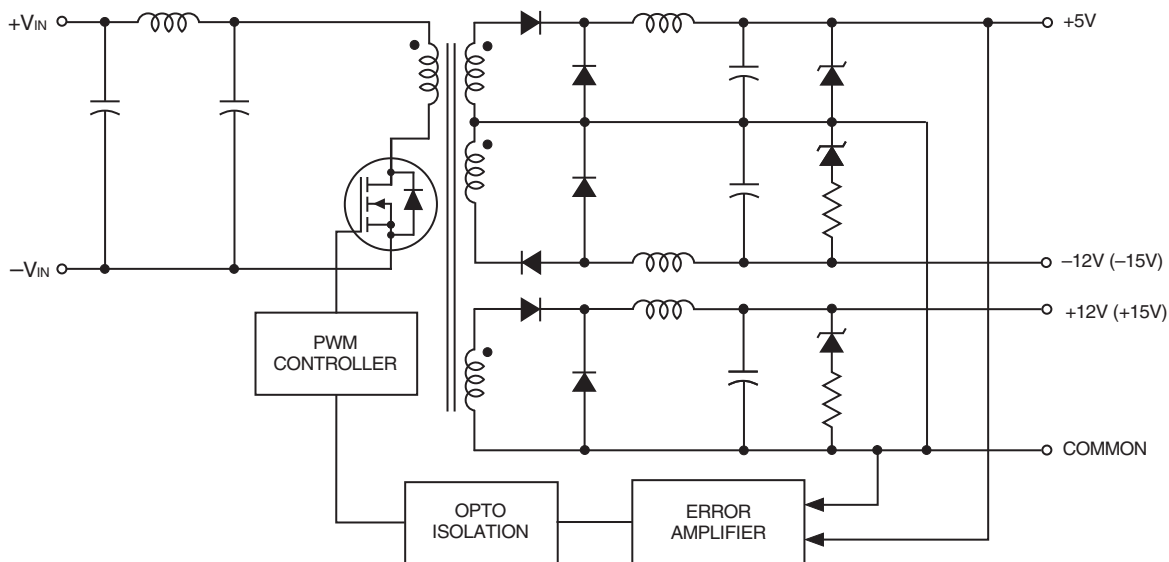

Figure 1. Simplified Schematic
Typical topology is shown



PERFORMANCE SPECIFICATIONS SUMMARY AND ORDERING GUIDE ①

Model	V _{OUT}	I _{OUT} (Max.)	R/N (mV pk-pk) ②		Regulation (Max.)		V _{IN} (Nom.)	Range	I _{in} ④	Efficiency		Package
	V	mA	Typ.	Max.	Line	Load ③	V	V	mA	Min.	Typ.	Case, Pinout
TWR-5/1000-12/125-D5A	+5	1000	75	100	±1.0%	±2.0%	5	4.7-7	100/2324	74%	76%	C3, P5
	±12	±125	100	150	±5.0%	±5.0%						
TWR-5/1000-12/210-D12A	+5	1000	75	100	±1.0%	±2.0%	12	9-18	50/1087	80.5%	82%	C3, P5
	±12	±210	100	150	±5.0%	±5.0%						
TWR-5/1000-12/210-D24A	+5	1000	75	100	±1.0%	±2.0%	24	18-36	50/534	82%	84%	C3, P5
	±12	±210	100	150	±5.0%	±5.0%						
TWR-5/1000-12/210-D48A	+5	1000	75	100	±1.0%	±2.0%	48	36-72	50/267	82%	84%	C3, P5
	±12	±210	100	150	±5.0%	±5.0%						
TWR-5/800-15/150-D5A	+5	800	75	100	±1.0%	±2.0%	5	4.7-7	100/2441	74%	76%	C3, P5
	±15	±150	125	175	±5.0%	±5.0%						
TWR-5/1000-15/200-D12A	+5	1000	75	100	±1.0%	±2.0%	12	9-18	50/1187	79%	82%	C3, P5
	±15	±200	125	175	±5.0%	±5.0%						
TWR-5/1000-15/200-D24A	+5	1000	75	100	±1.0%	±2.0%	24	18-36	50/572	82%	84%	C3, P5
	±15	±200	125	175	±5.0%	±5.0%						
TWR-5/1000-15/200-D48A	+5	1000	75	100	±1.0%	±2.0%	48	36-72	50/286	82%	84%	C3, P5
	±15	±200	125	175	±5.0%	±5.0%						

① Typical @ TA = +25°C under nominal line voltage and full-load conditions unless otherwise noted.
② 20MHz bandwidth. ±12/15V outputs are specified with 10µF, 25V output capacitors.

③ 5V output, 10% to 100% load. ±12/15V outputs, balanced loads, 20% to 100% load.
④ Nominal line voltage, no-load/full-load conditions.

PART NUMBER STRUCTURE

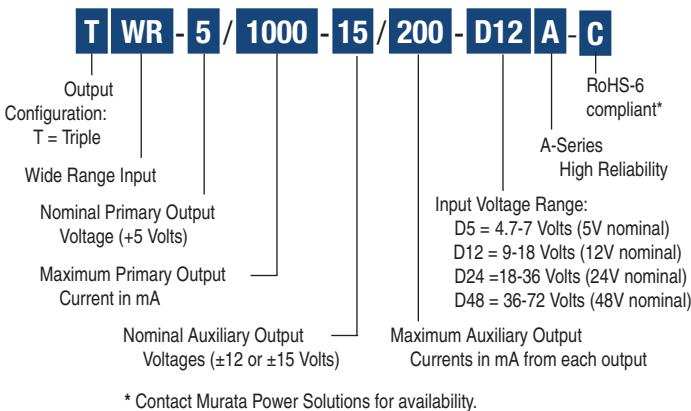

TEMPERATURE DERATING

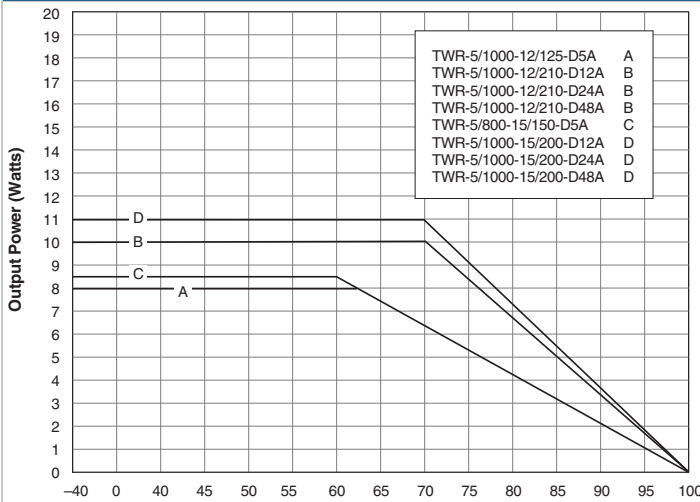

MECHANICAL SPECIFICATIONS

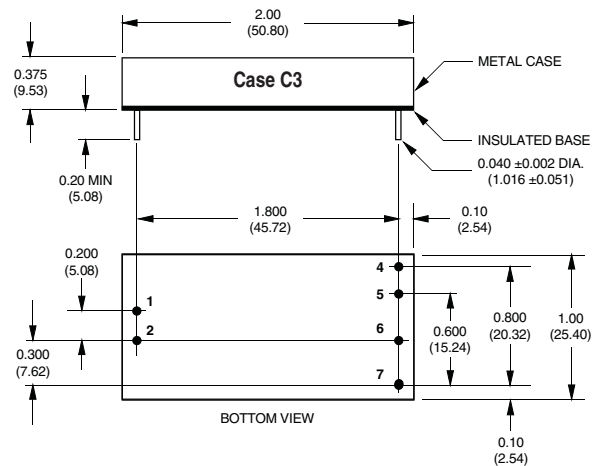

INPUT/OUTPUT CONNECTIONS

Pin	Function P5
1	+Input
2	-Input
3	No Pin
4	+12V/15V Out
5	-12V/15V Out
6	Common
7	+5V Out

Notes:
For "D5A/D12A/D24A" models, the case is connected to pin 2 (-VIN).
For "D48A" models, the case is connected to pin 1 (+VIN).

Performance/Functional Specifications

Typical @ TA = +25°C under nominal line voltage and full-load conditions, unless noted. ①

Input	
Input Voltage Ranges:	
"D5A" Models	4.7-7 Volts (5V nominal)
"D12A" Models	9-18 Volts (12V nominal)
"D24A" Models	18-36 Volts (24V nominal)
"D48A" Models	36-72 Volts (48V nominal)
Input Current	See Ordering Guide
Input Filter Type ②	Pi
Reverse-Polarity Protection	Yes (Instantaneous, 6A maximum)
Output	
V _{OUT} Accuracy (50% loads):	
+5V Output	±0.5%
±12V or ±15V Outputs	±3%
Temperature Coefficient	±0.02% per °C
Ripple/Noise (20MHz BW) ②	See Ordering Guide
Line/Load Regulation	See Ordering Guide
Efficiency	See Ordering Guide
Isolation Voltage ③	1500Vdc, minimum
Isolation Capacitance	300pF
Current Limiting	Auto-recovery
Oversvoltage Protection	Zener/transorb clamps, magnetic feedback
Dynamic Characteristics	
Transient Response (50% load step)	200µsec max. to ±2% of final value
Switching Frequency	175kHz
Environmental	
Operating Temperature (Ambient):	
Without Derating	-40 to +60/70°C (Model dependent)
With Derating	to +100°C (See Derating Curve)
Storage Temperature	-40 to +105°C
Flammability	UL94V-0
Physical	
Dimensions	2" x 1" x 0.375" (51 x 25 x 9.5mm)
Shielding	5-sided
Case Connection	Pin 2 (-VIN) ④
Case Material	Corrosion resistant steel with non-conductive, epoxy-based, black enamel finish and plastic baseplate
Pin Material	Gold-plated copper alloy
Weight	1.3 ounces (37 grams)

① These power converters require a minimum 10% loading on their primary output and a minimum 20% loading on their auxiliary outputs to maintain specified regulation. Operation under no-load conditions will not damage these devices; however they may not meet all listed specifications.

② Application-specific internal input/output filtering can be recommended or perhaps added internally upon request. Contact DATEL Applications Engineering for details.

③ Devices can be screened or modified for higher guaranteed isolation voltages. Contact DATEL Applications Engineering for details.

④ On "D48A" models, the case is connected to pin 1 (+VIN).

Absolute Maximum Ratings

Input Voltage:	
"D5A" Models	10 Volts
"D12A" Models	22 Volts
"D24A" Models	44 Volts
"D48A" Models	80 Volts
Input Reverse-Polarity Protection	Current must be <6A. Brief duration only. Fusing recommended.
Output Oversvoltage Protection	
+5V Output	6.8 Volts, limited duration
±12V Outputs	±13 Volts, limited duration
±15V Outputs	±16 Volts, limited duration
Output Current	Current limited. Max. current and short-circuit duration model dependent.
Storage Temperature	-40 to +105°C
Lead Temperature (soldering, 10 sec.)	+300°C

These are stress ratings. Exposure of devices to any of these conditions may adversely affect long-term reliability. Proper operation under conditions other than those listed in the Performance/Functional Specifications Table is not implied.

TECHNICAL NOTES

Filtering and Noise Reduction

All A-Series TWR 8-11 Watt DC/DC Converters achieve their rated ripple and noise specifications without the use of external input/ output capacitors. In critical applications, input/output ripple and noise may be further reduced by installing electrolytic capacitors across the input terminals and/or low-ESR tantalum or electrolytic capacitors across the output terminals. Output capacitors should be connected between their respective output pin (pin 4, 5 or 7) and Common (pin 6) as shown in Figure 2. The caps should be located as close to the power converters as possible. Typical values are listed below. In many applications, using values greater than those listed will yield better results.

To Reduce Input Ripple

"D5A" Models	47µF, 10V
"D12A" Models	20µF, 25V
"D24A" Models	20µF, 50V
"D48A" Models	10µF, 100V

To Reduce Output Ripple

+5V Output	47µF, 10V, Low ESR
±12/15V Outputs	22µF, 20V, Low ESR

In critical, space-sensitive applications, DATEL may be able to tailor the internal input/output filtering of these units to meet your specific requirements. Contact our Applications Engineering Group for additional details.

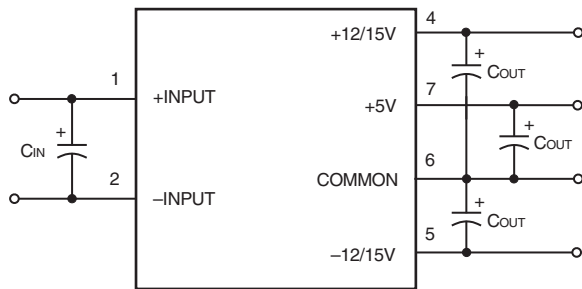

Figure 2. Using External Capacitors to Reduce Input/Output Ripple/Noise

EMI RADIATED EMISSIONS

If you're designing with EMC in mind, please note that all of DATEL's TWR 8-11 Watt A-Series DC/DC Converters have been characterized for radiated and conducted emissions in our new EMI/ EMC laboratory. Testing is conducted in an EMC0 5305 GTEM test cell utilizing EMC0 automated EMC test software. Radiated emissions are tested to the limits of FCC Part 15, Class B and CISPR 22 (EN 55022), Class B. Correlation to other specifications can be supplied upon request. Radiated emissions plots to FCC and CISPR 22 for model TWR-5/1000-12/125-D5A appear below. Published EMC test reports are available for each model number. Contact DATEL's Applications Engineering Department for more details.

Input Fusing

Certain applications and/or safety agencies may require the installation of fuses at the inputs of power conversion components. For DATEL A-Series TWR 8-11 Watt DC/DC Converters, you should use slow-blow type fuses with values no greater than 3A.

CUSTOM CAPABILITIES

DATEL's world-class design, development and manufacturing team stands ready to work with you to deliver the exact power converter you need for your demanding, large volume, OEM applications. And ... we'll do it on time and within budget!

Our experienced applications and design staffs; quick-turn prototype capability; highly automated, SMT assembly facilities; and in-line SPC quality-control techniques combine to give us the unique ability to design and deliver any quantity of power converters to the highest standards of quality and reliability.

We have compiled a large library of DC/DC designs that are currently used in a variety of telecom, medical, computer, railway, aerospace and industrial applications. We may already have the converter you need.

Contact us. Our goal is to provide you the highest-quality, most cost-effective power converters available.

**TWR-5/1000-12/125-D5A Radiated Emissions
FCC Part 15 Class B, 3 Meters
Converter Output = +5Vdc @ 950mA and ±12Vdc @ ±114mA**

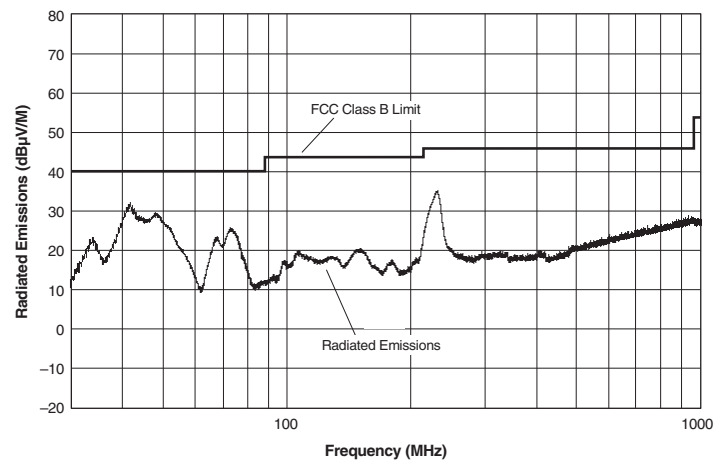

**TWR-5/1000-12/125-D5A Radiated Emissions
EN 55022 Class B, 10 Meters
Converter Output = +5Vdc @ 950mA and ±12Vdc @ ±114mA**

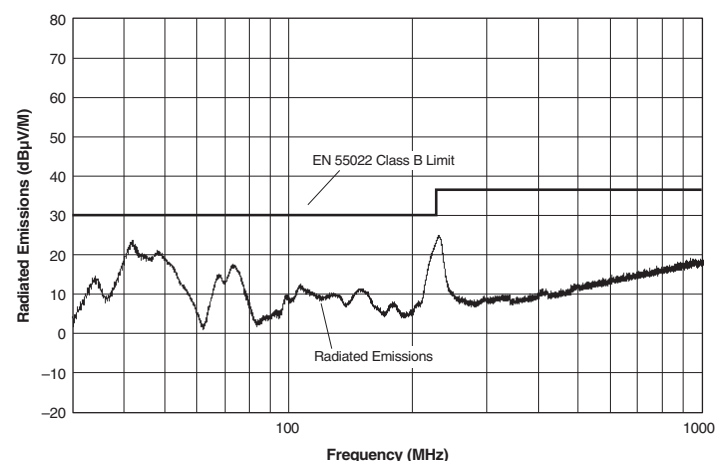

Quality and Reliability

The A-Series are the first DC/DC Converters to emerge from DATEL's new, company-wide approach to designing and manufacturing the most reliable power converters available. The five-pronged program draws our Quality Assurance function into all aspects of new-product design, development, characterization, qualification and manufacturing.

Design for Reliability

Design for Reliability is woven throughout our multi-phased, new-product development process. Design-for-reliability practices are fully documented and begin early in the new-product development cycle with the following goals:

1. To work from an approved components/vendors list ensuring the use of reliable components and the rigorous qualification of new components.
2. To design with safety margins by adhering to a strict set of derating guidelines and performing theoretical worst-case analyses.
3. To locate potential design weaknesses early in the product-development cycle by using extensive HALT (Highly Accelerated Life Testing).
4. To prove that early design improvements are effective by employing a thorough FRACA (Failure Reporting Analysis and Corrective Action) system.

HALT Testing

The goal of the accelerated-stress techniques used by DATEL is to force device maturity, in a short period of time, by exposing devices to excessive levels of "every stimulus of potential value." We use HALT (Highly Accelerated Life Testing) repeatedly during the design and early manufacturing phases to detect potential electrical and mechanical design weaknesses that could result in possible future field failures.

During HALT, prototype and pre-production DC/DC converters are subjected to progressively higher stress levels induced by thermal cycling, rate of temperature change, vibration, power cycling, product-specific stresses (such as dc voltage variation) and combined environments. The stresses are not meant to simulate field environments but to expose any weaknesses in a product's electro/mechanical design and/or assembly processes. The goal of HALT is to make products fail so that device weaknesses can be analyzed and strengthened as appropriate. Applied stresses are continually stepped up until products

eventually fail. After corrective actions and/or design changes, stresses are stepped up again and the cycle is repeated until the "fundamental limit of the technology" is determined.

DATEL has invested in a Qualmark OVS-1 HALT tester capable of applying voltage and temperature extremes as well as 6-axis, linear and rotational, random vibration. A typical HALT profile (shown above) consists of thermal cycling (-55 to +125°C, 30°C/minute) and simultaneous, gradually increasing, random longitudinal and rotational vibration up to 20G's with load cycling and applied-voltage extremes added as desired. Many devices in DATEL's new A-Series could not be made to fail prior to reaching either the limits of the HALT chamber or some previously known physical limit of the device. We also use the HALT chamber and its ability to rapidly cool devices to verify their "cold-start" capabilities.

Qualification

For each new product, electrical performance is verified via a comprehensive characterization process and long-term reliability is confirmed via a rigorous qualification procedure. The qual procedure includes such strenuous tests as thermal shock and 500 hour life. Qual testing is summarized below.

QUALIFICATION TESTING	
Qualification Test	Method/Comments
HALT	DATEL in-house procedure
High Temperature Storage	Max. rated temp., 1,000 hours
Thermal Shock	10 cycles, -55 to +125°C
Temperature/Humidity	+85°C, 85% humidity, 48 hours
Lead Integrity	DATEL in-house procedure
Life Test	+70°C, 500 hours*
Marking Permanency	DATEL in-house procedure
End Point Electrical Tests	Per product specification

Typical HALT Profile

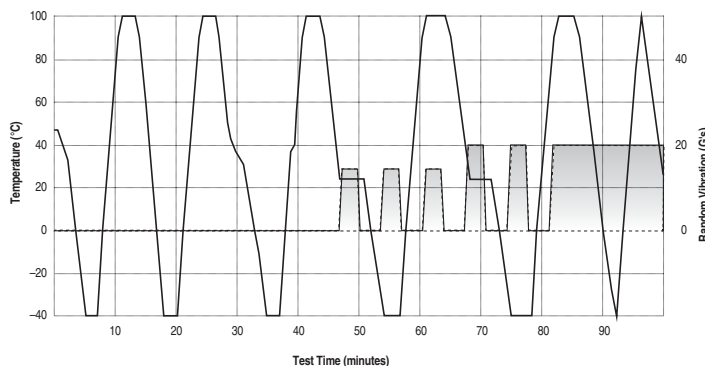

Murata Power Solutions, Inc.
11 Cabot Boulevard, Mansfield, MA 02048-1151 U.S.A.
ISO 9001 and 14001 REGISTERED



**This product is subject to the following [operating requirements](#) and the [Life and Safety Critical Application Sales Policy](#):
Refer to: <http://www.murata-ps.com/requirements/>**

Murata Power Solutions, Inc. makes no representation that the use of its products in the circuits described herein, or the use of other technical information contained herein, will not infringe upon existing or future patent rights. The descriptions contained herein do not imply the granting of licenses to make, use, or sell equipment constructed in accordance therewith. Specifications are subject to change without notice. © 2012 Murata Power Solutions, Inc.



Компания «ЭлектроПласт» предлагает заключение долгосрочных отношений при поставках импортных электронных компонентов на взаимовыгодных условиях!

Наши преимущества:

- Оперативные поставки широкого спектра электронных компонентов отечественного и импортного производства напрямую от производителей и с крупнейших мировых складов;
- Поставка более 17-ти миллионов наименований электронных компонентов;
- Поставка сложных, дефицитных, либо снятых с производства позиций;
- Оперативные сроки поставки под заказ (от 5 рабочих дней);
- Экспресс доставка в любую точку России;
- Техническая поддержка проекта, помощь в подборе аналогов, поставка прототипов;
- Система менеджмента качества сертифицирована по Международному стандарту ISO 9001;
- Лицензия ФСБ на осуществление работ с использованием сведений, составляющих государственную тайну;
- Поставка специализированных компонентов (Xilinx, Altera, Analog Devices, Intersil, Interpoint, Microsemi, Aeroflex, Peregrine, Syfer, Eurofarad, Texas Instrument, Miteq, Cobham, E2V, MA-COM, Hittite, Mini-Circuits, General Dynamics и др.);

Помимо этого, одним из направлений компании «ЭлектроПласт» является направление «Источники питания». Мы предлагаем Вам помощь Конструкторского отдела:

- Подбор оптимального решения, техническое обоснование при выборе компонента;
- Подбор аналогов;
- Консультации по применению компонента;
- Поставка образцов и прототипов;
- Техническая поддержка проекта;
- Защита от снятия компонента с производства.



Как с нами связаться

Телефон: 8 (812) 309 58 32 (многоканальный)

Факс: 8 (812) 320-02-42

Электронная почта: org@eplast1.ru

Адрес: 198099, г. Санкт-Петербург, ул. Калинина, дом 2, корпус 4, литера А.