

RF Power Field Effect Transistors

N-Channel Enhancement-Mode Lateral MOSFETs

RF power transistors designed for applications operating at frequencies from 900 to 1215 MHz. These devices are suitable for use in defense and commercial pulse applications, such as IFF and DME.

- Typical Pulse Performance: $V_{DD} = 50$ Vdc, $I_{DQ} = 200$ mA, Pulse Width = 128 μ sec, Duty Cycle = 10%

| Application | P_{out} (W) | f (MHz) | G_{ps} (dB) | η_D (%) |
|-------------|---------------|----------|---------------|--------------|
| Narrowband | 500 Peak | 1030 | 19.7 | 62.0 |
| Broadband | 500 Peak | 960-1215 | 18.5 | 57.0 |

- Capable of Handling 10:1 VSWR, @ 50 Vdc, 1030 MHz, 500 W Peak Power

Features

- Characterized with Series Equivalent Large-Signal Impedance Parameters
- Internally Matched for Ease of Use
- Qualified Up to a Maximum of 50 V_{DD} Operation
- Integrated ESD Protection
- Greater Negative Gate-Source Voltage Range for Improved Class C Operation
- In Tape and Reel. R5 Suffix = 50 Units, 56 mm Tape Width, 13-inch Reel.

MMRF1009HR5
MMRF1009HSR5

960-1215 MHz, 500 W, 50 V PULSE
LATERAL N-CHANNEL
RF POWER MOSFETs

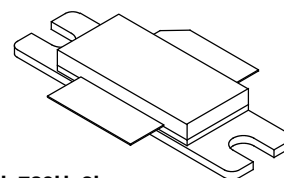

NI-780H-2L
MMRF1009HR5

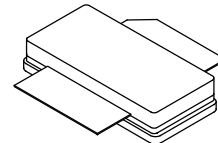

NI-780S-2L
MMRF1009HSR5

Table 1. Maximum Ratings

| Rating | Symbol | Value | Unit |
|---|-----------|-------------|--------------|
| Drain-Source Voltage | V_{DSS} | -0.5, +110 | Vdc |
| Gate-Source Voltage | V_{GS} | -6.0, +10 | Vdc |
| Storage Temperature Range | T_{stg} | -65 to +150 | $^{\circ}$ C |
| Case Operating Temperature | T_C | 150 | $^{\circ}$ C |
| Operating Junction Temperature ⁽¹⁾ | T_J | 225 | $^{\circ}$ C |

Table 2. Thermal Characteristics

| Characteristic | Symbol | Value ⁽²⁾ | Unit |
|---|-----------------|----------------------|----------------|
| Thermal Impedance, Junction to Case Case Temperature 80 $^{\circ}$ C, 500 W Pulse, 128 μ sec Pulse Width, 10% Duty Cycle | $Z_{\theta JC}$ | 0.044 | $^{\circ}$ C/W |

1. Continuous use at maximum temperature will affect MTTF.
2. Refer to AN1955, *Thermal Measurement Methodology of RF Power Amplifiers*. Go to <http://www.freescale.com/rf>. Select Documentation/Application Notes - AN1955.

Table 3. ESD Protection Characteristics

| Test Methodology | Class |
|---------------------------------------|-------------------|
| Human Body Model (per JESD22-A114) | 2, passes 2600 V |
| Machine Model (per EIA/JESD22-A115) | B, passes 200 V |
| Charge Device Model (per JESD22-C101) | IV, passes 2000 V |

Table 4. Electrical Characteristics ($T_A = 25^\circ\text{C}$ unless otherwise noted)

| Characteristic | Symbol | Min | Typ | Max | Unit |
|----------------|--------|-----|-----|-----|------|
|----------------|--------|-----|-----|-----|------|

Off Characteristics

| | | | | | |
|---|---------------|-----|---|-----|-----------------|
| Gate-Source Leakage Current ($V_{GS} = 5\text{ Vdc}$, $V_{DS} = 0\text{ Vdc}$) | I_{GSS} | — | — | 10 | μAdc |
| Drain-Source Breakdown Voltage ($V_{GS} = 0\text{ Vdc}$, $I_D = 200\text{ mA}$) | $V_{(BR)DSS}$ | 110 | — | — | Vdc |
| Zero Gate Voltage Drain Leakage Current ($V_{DS} = 50\text{ Vdc}$, $V_{GS} = 0\text{ Vdc}$) | I_{DSS} | — | — | 20 | μAdc |
| Zero Gate Voltage Drain Leakage Current ($V_{DS} = 90\text{ Vdc}$, $V_{GS} = 0\text{ Vdc}$) | I_{DSS} | — | — | 200 | μAdc |

On Characteristics

| | | | | | |
|---|--------------|-----|------|-----|-----|
| Gate Threshold Voltage ($V_{DS} = 10\text{ Vdc}$, $I_D = 1.32\text{ mA}$) | $V_{GS(th)}$ | 0.9 | 1.7 | 2.4 | Vdc |
| Gate Quiescent Voltage ($V_{DD} = 50\text{ Vdc}$, $I_D = 200\text{ mAdc}$, Measured in Functional Test) | $V_{GS(Q)}$ | 1.7 | 2.4 | 3.2 | Vdc |
| Drain-Source On-Voltage ($V_{GS} = 10\text{ Vdc}$, $I_D = 3.26\text{ Adc}$) | $V_{DS(on)}$ | — | 0.25 | — | Vdc |

Dynamic Characteristics (1)

| | | | | | |
|---|-----------|---|------|---|----|
| Reverse Transfer Capacitance ($V_{DS} = 50\text{ Vdc} \pm 30\text{ mV(rms)ac}$ @ 1 MHz, $V_{GS} = 0\text{ Vdc}$) | C_{rss} | — | 0.2 | — | pF |
| Output Capacitance ($V_{DS} = 50\text{ Vdc} \pm 30\text{ mV(rms)ac}$ @ 1 MHz, $V_{GS} = 0\text{ Vdc}$) | C_{oss} | — | 697 | — | pF |
| Input Capacitance ($V_{DS} = 50\text{ Vdc}$, $V_{GS} = 0\text{ Vdc} \pm 30\text{ mV(rms)ac}$ @ 1 MHz) | C_{iss} | — | 1391 | — | pF |

Functional Tests (In Freescale Narrowband Test Fixture, 50 ohm system) $V_{DD} = 50\text{ Vdc}$, $I_{DQ} = 200\text{ mA}$, $P_{out} = 500\text{ W Peak}$ (50 W Avg.), $f = 1030\text{ MHz}$, 128 μsec Pulse Width, 10% Duty Cycle

| | | | | | |
|-------------------|----------|------|------|------|----|
| Power Gain | G_{ps} | 18.5 | 19.7 | 22.0 | dB |
| Drain Efficiency | η_D | 58.0 | 62.0 | — | % |
| Input Return Loss | IRL | — | -18 | -9 | dB |

Typical Broadband Performance — 960-1215 MHz (In Freescale 960-1215 MHz Test Fixture, 50 ohm system) $V_{DD} = 50\text{ Vdc}$, $I_{DQ} = 200\text{ mA}$, $P_{out} = 500\text{ W Peak}$ (50 W Avg.), $f = 960\text{-}1215\text{ MHz}$, 128 μsec Pulse Width, 10% Duty Cycle

| | | | | | |
|------------------|----------|---|------|---|----|
| Power Gain | G_{ps} | — | 18.5 | — | dB |
| Drain Efficiency | η_D | — | 57.0 | — | % |

1. Part internally matched both on input and output.

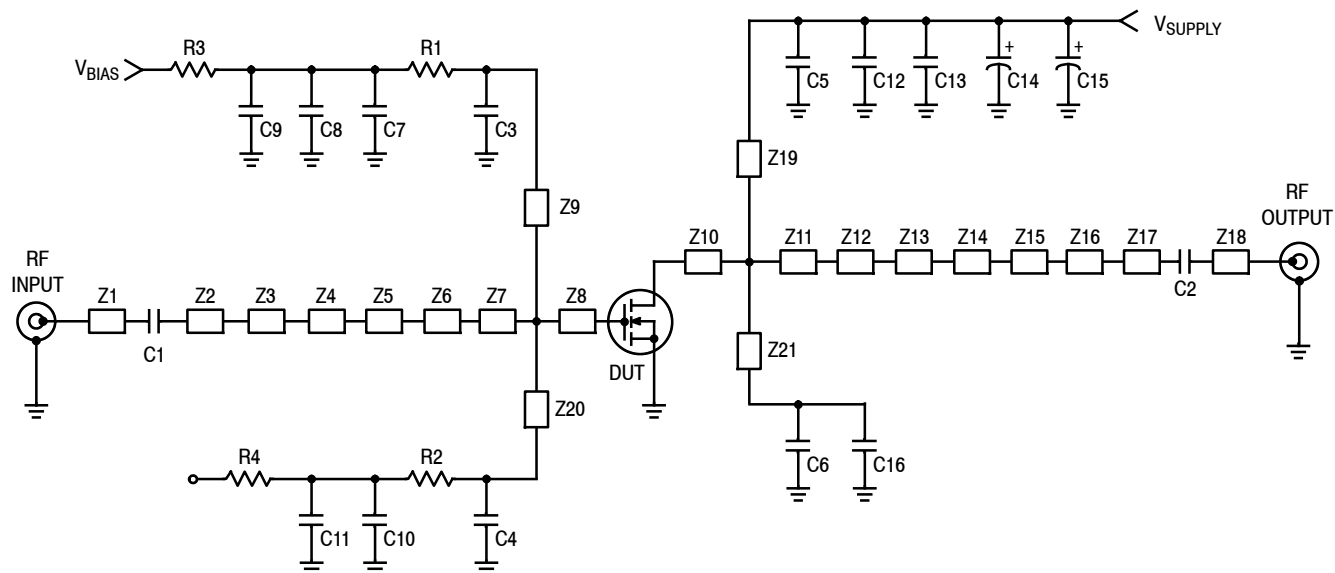

| | | | |
|---------|----------------------------|----------|--|
| Z1 | 0.457" x 0.080" Microstrip | Z11 | 0.161" x 1.500" Microstrip |
| Z2 | 0.250" x 0.080" Microstrip | Z12 | 0.613" x 1.281" Microstrip |
| Z3 | 0.605" x 0.040" Microstrip | Z13 | 0.248" x 0.865" Microstrip |
| Z4 | 0.080" x 0.449" Microstrip | Z14 | 0.087" x 0.425" Microstrip |
| Z5 | 0.374" x 0.608" Microstrip | Z15 | 0.309" x 0.090" Microstrip |
| Z6 | 0.118" x 1.252" Microstrip | Z16 | 0.193" x 0.516" Microstrip |
| Z7 | 0.778" x 1.710" Microstrip | Z17 | 0.279" x 0.080" Microstrip |
| Z8 | 0.095" x 1.710" Microstrip | Z18 | 0.731" x 0.080" Microstrip |
| Z9, Z20 | 0.482" x 0.050" Microstrip | Z19, Z21 | 0.507" x 0.040" Microstrip |
| Z10 | 0.138" x 1.500" Microstrip | PCB | Arlon CuClad 250GX-0300-55-22, 0.030", $\epsilon_r = 2.55$ |

Figure 1. MMRF1009HR5(HSR5) Test Circuit Schematic

Table 5. MMRF1009HR5(HSR5) Test Circuit Component Designations and Values

| Part | Description | Part Number | Manufacturer |
|-------------------|---|----------------------|--------------|
| C1, C2 | 5.1 pF Chip Capacitors | ATC100B5R1CT500XT | ATC |
| C3, C4, C5, C6 | 33 pF Chip Capacitors | ATC100B330JT500XT | ATC |
| C7, C10 | 10 μ F, 50 V Chip Capacitors | GRM55DR61H106KA88L | Murata |
| C8, C11, C13, C16 | 2.2 μ F, 100 V Chip Capacitors | 2225X7R225KT3AB | ATC |
| C9 | 22 μ F, 25 V Chip Capacitor | TPSD226M025R0200 | AVX |
| C12 | 1 μ F, 100 V Chip Capacitor | GRM31CR72A105KA01L | Murata |
| C14, C15 | 470 μ F, 63 V Electrolytic Capacitors | MCGPR63V477M13X26-RH | Multicomp |
| R1, R2 | 56 Ω , 1/4 W Chip Resistors | CRCW120656R0FKEA | Vishay |
| R3, R4 | 0 Ω , 3 A Chip Resistors | CRCW12060000Z0EA | Vishay |

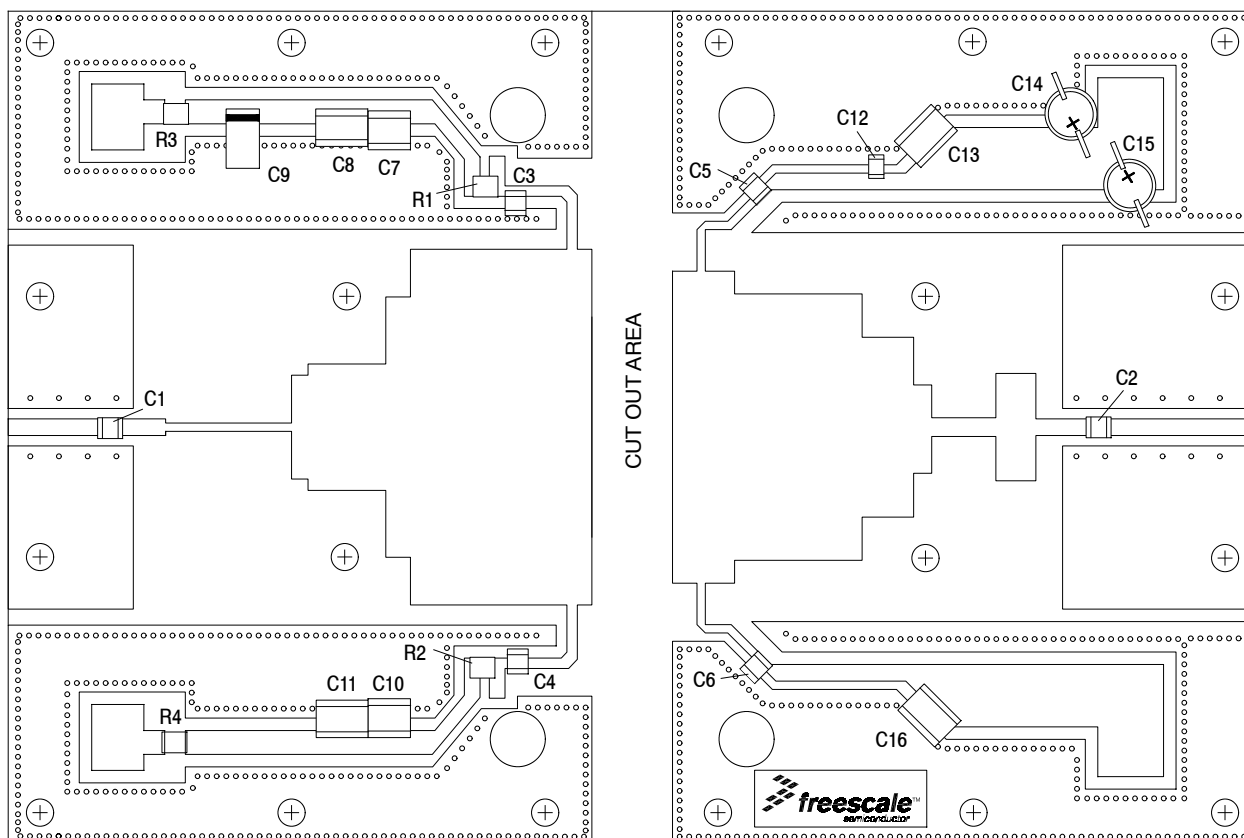

Figure 2. MMRF1009HR5(HSR5) Test Circuit Component Layout

TYPICAL CHARACTERISTICS

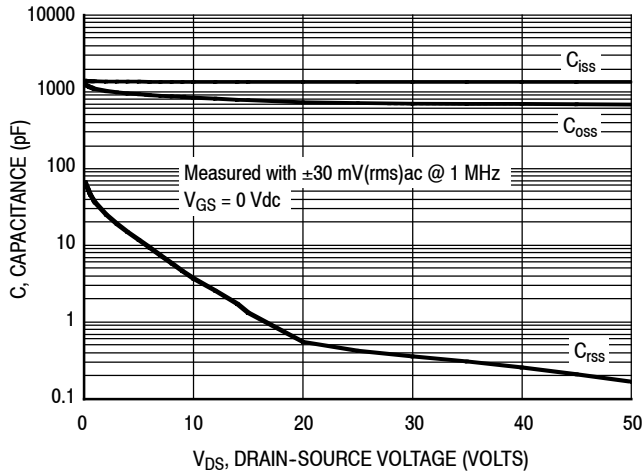

Figure 3. Capacitance versus Drain-Source Voltage

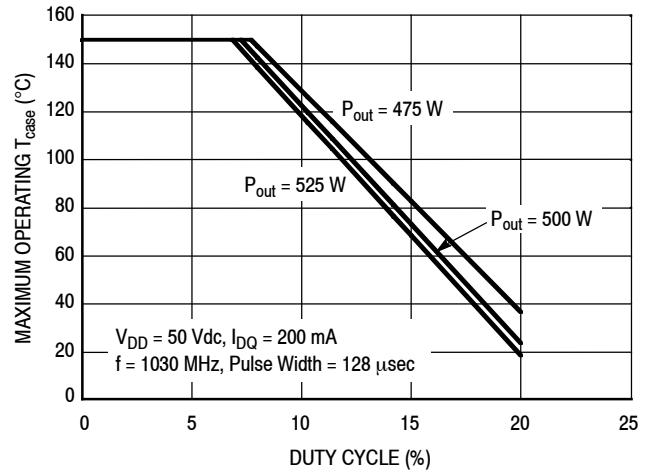

Figure 4. Safe Operating Area

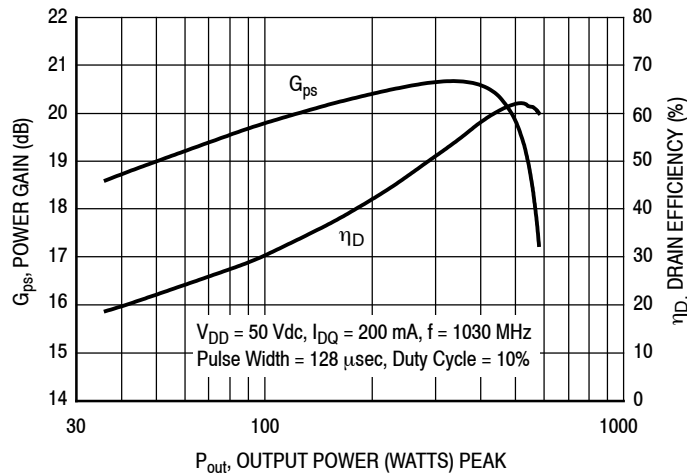

Figure 5. Power Gain and Drain Efficiency versus Output Power

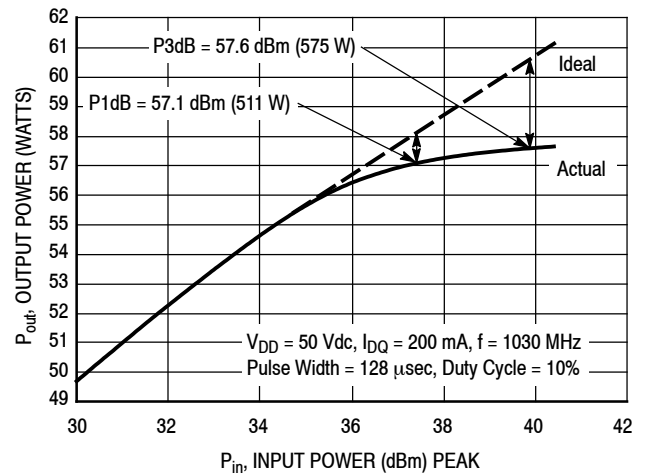

Figure 6. Output Power versus Input Power

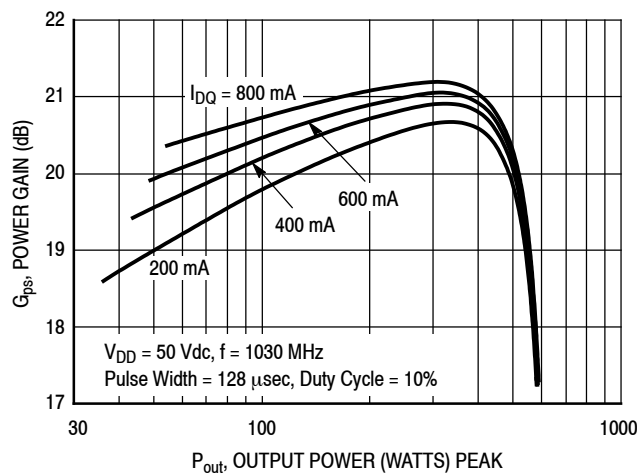

Figure 7. Power Gain versus Output Power

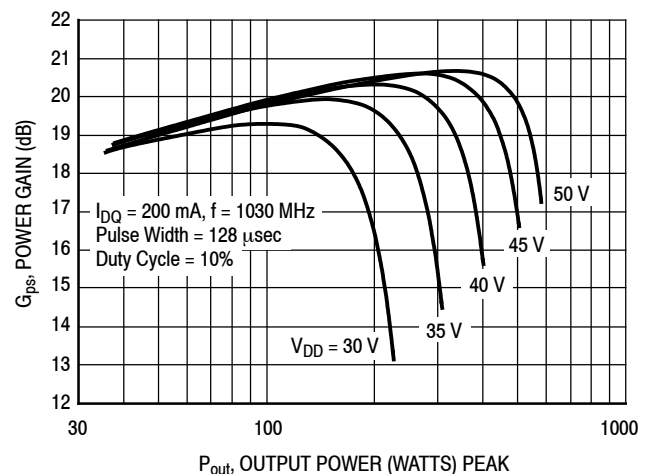

Figure 8. Power Gain versus Output Power

TYPICAL CHARACTERISTICS

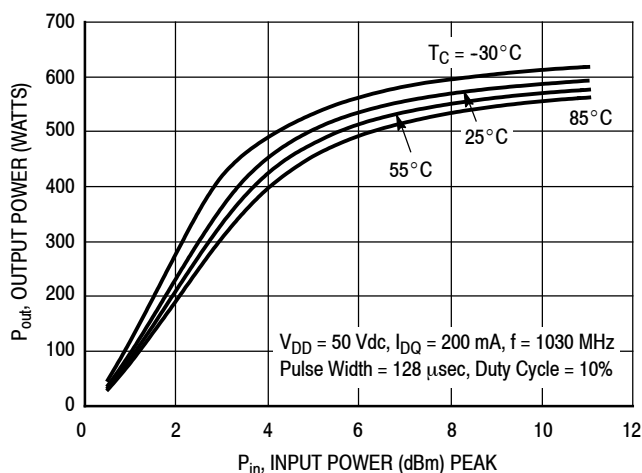

Figure 9. Output Power versus Input Power

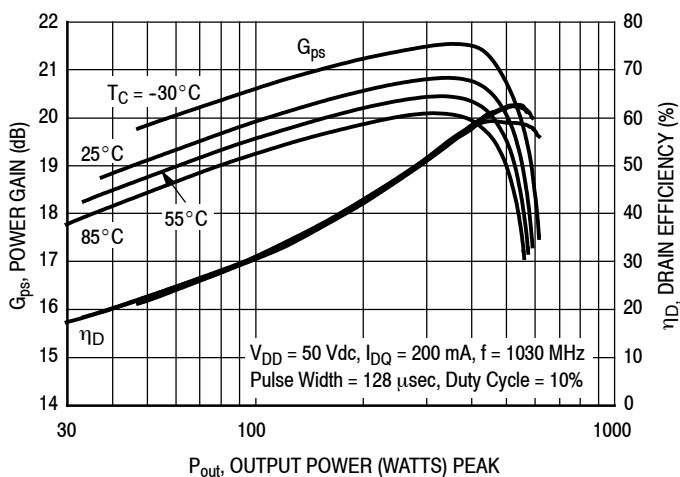
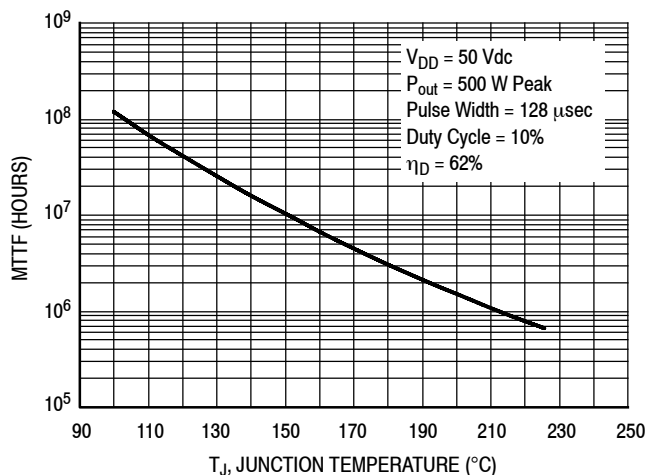

Figure 10. Power Gain and Drain Efficiency versus Output Power



MTTF calculator available at <http://www.freescale.com/rf>. Select Software & Tools/Development Tools/Calculators to access MTTF calculators by product.

Figure 11. MTTF versus Junction Temperature

$V_{DD} = 50 \text{ Vdc}$, $I_{DQ} = 200 \text{ mA}$, $P_{out} = 500 \text{ W Peak}$

| f MHz | Z_{source} Ω | Z_{load} Ω |
|----------|-------------------|-----------------|
| 1030 | 1.36 - j1.27 | 2.50 - j0.17 |

Z_{source} = Test circuit impedance as measured from gate to ground.

Z_{load} = Test circuit impedance as measured from drain to ground.

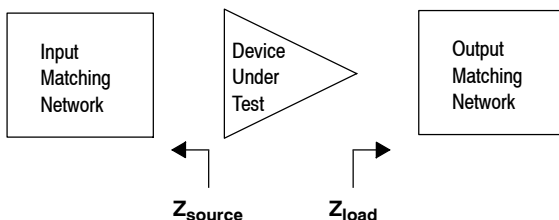

Figure 12. Series Equivalent Source and Load Impedance

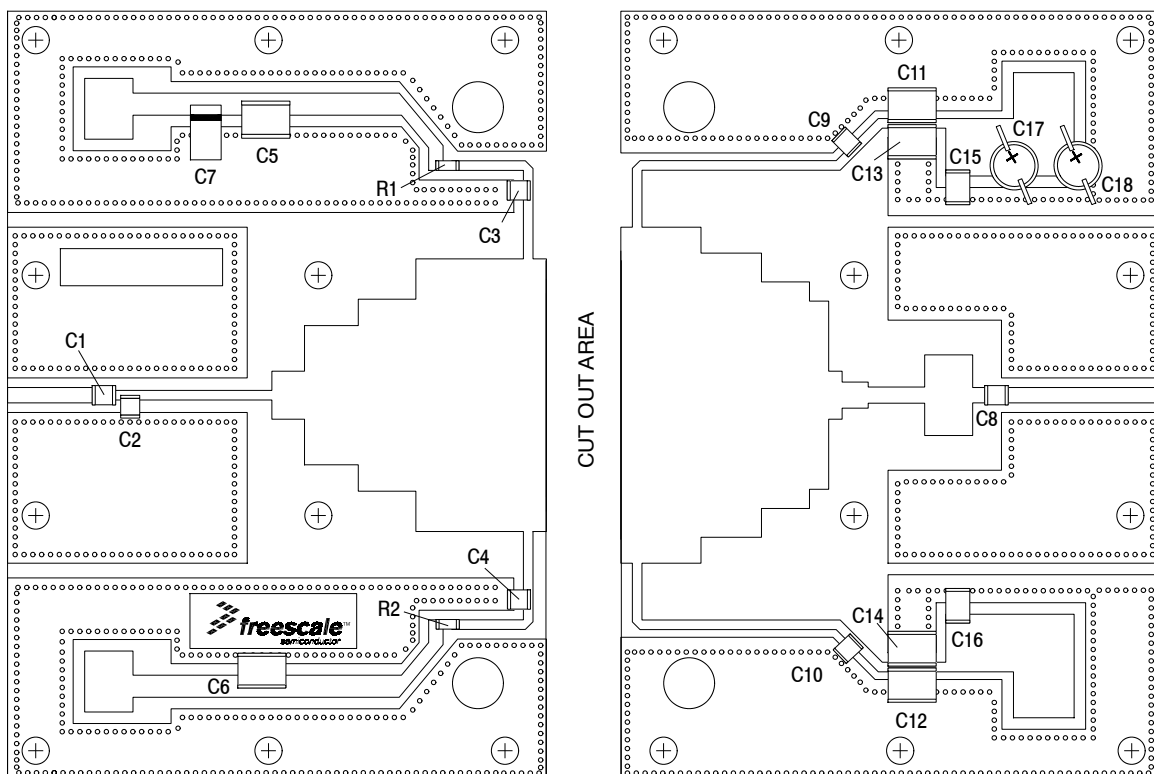

Figure 13. MMRF1009HR5(HSR5) Test Circuit Component Layout — 960-1215 MHz

Table 6. MMRF1009HR5(HSR5) Test Circuit Component Designations and Values — 960-1215 MHz

| Part | Description | Part Number | Manufacturer |
|------------------|---|----------------------|--------------|
| C1 | 2.2 pF Chip Capacitor | ATC100B2R2JT500XT | ATC |
| C2 | 0.2 pF Chip Capacitor | ATC100B0R2BT500XT | ATC |
| C3, C4 | 33 pF Chip Capacitors | ATC100B330JT500XT | ATC |
| C5, C6, C11, C12 | 2.2 μ F, 100 V Chip Capacitors | G2225X7R225KT3AB | ATC |
| C7 | 22 μ F, 35 V Tantalum Capacitor | T491X226K035AT | Kemet |
| C8 | 8.2 pF Chip Capacitor | ATC100B8R2CT500XT | ATC |
| C9, C10 | 39 pF Chip Capacitors | ATC100B390JT500XT | ATC |
| C13, C14 | 0.022 μ F, 100 V Chip Capacitors | C1825C223K1GAC | Kemet |
| C15, C16 | 0.10 μ F, 100 V Chip Capacitors | C1812F104K1RAC | Kemet |
| C17, C18 | 470 μ F, 63 V Electrolytic Capacitors | MCGPR63V477M13X26-RH | Multicomp |
| R1, R2 | 22 Ω , 1/4 W Chip Resistors | CRCW120622R0FKEA | Vishay |
| PCB | 0.030", $\epsilon_r = 2.55$ | AD255A | Arlon |

TYPICAL CHARACTERISTICS — 960-1215 MHz

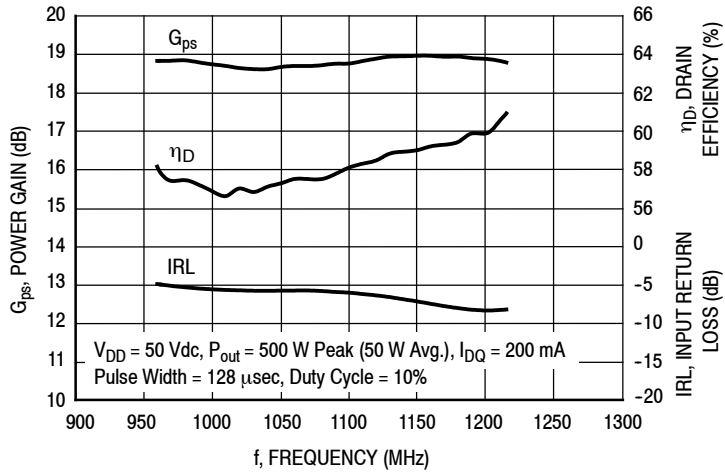

Figure 14. Power Gain, Drain Efficiency and IRL versus Frequency

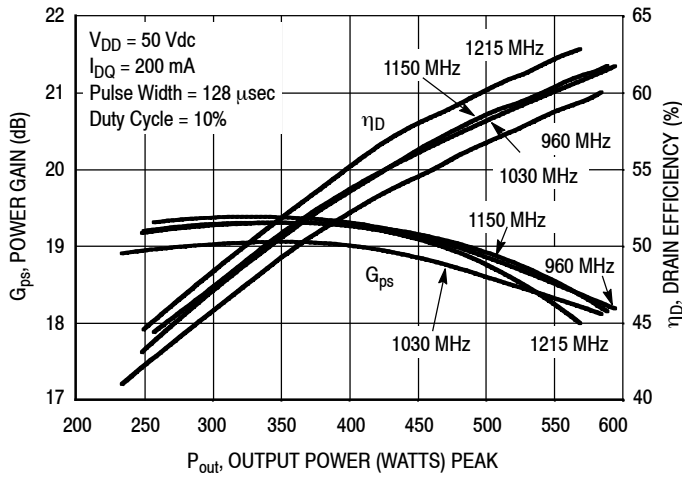
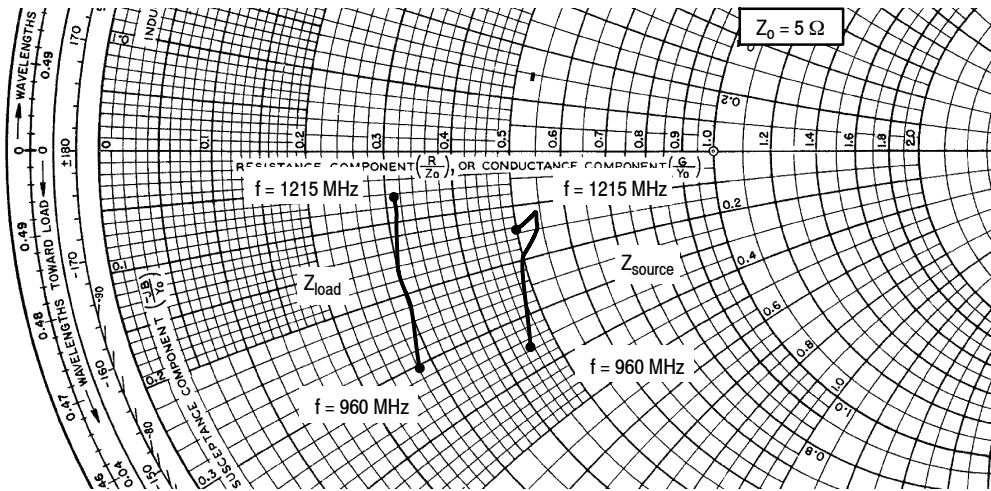

Figure 15. Power Gain and Drain Efficiency versus Output Power



$V_{DD} = 50 \text{ Vdc}$, $I_{DQ} = 200 \text{ mA}$, $P_{out} = 500 \text{ W Peak}$

| f MHz | Z_{source} Ω | Z_{load} Ω |
|----------|--------------------------|------------------------|
| 960 | $2.25 - j1.78$ | $1.38 - j1.53$ |
| 1030 | $2.51 - j1.02$ | $1.48 - j1.11$ |
| 1090 | $2.69 - j0.73$ | $1.51 - j0.78$ |
| 1150 | $2.71 - j0.65$ | $1.53 - j0.49$ |
| 1215 | $2.48 - j0.76$ | $1.53 - j0.33$ |

Z_{source} = Test circuit impedance as measured from gate to ground.

Z_{load} = Test circuit impedance as measured from drain to ground.

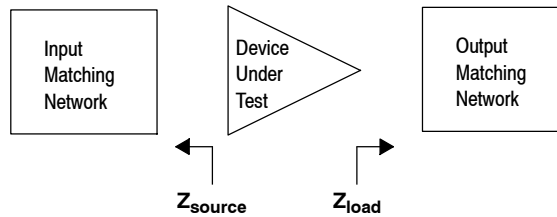
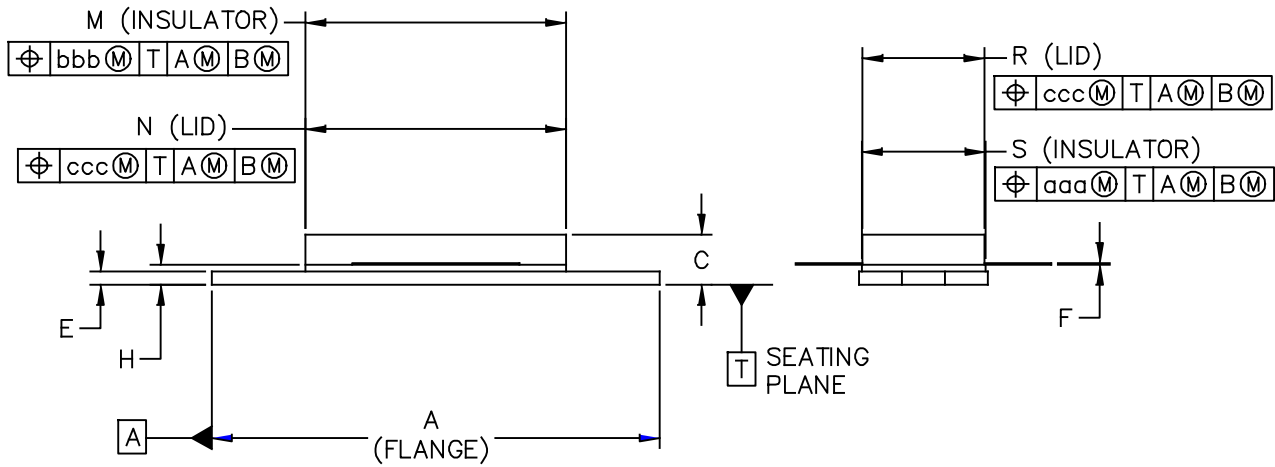
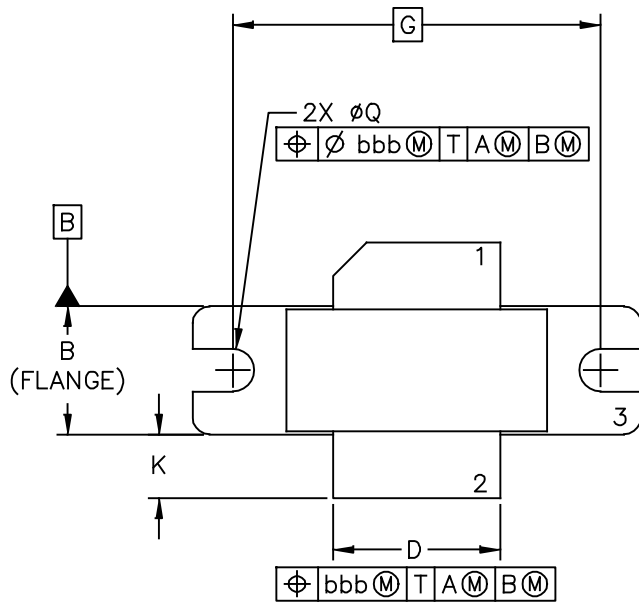

Figure 16. Series Equivalent Source and Load Impedance — 960-1215 MHz

PACKAGE DIMENSIONS



| | | | |
|---|--------------------------|----------------------------|-------------|
| © FREESCALE SEMICONDUCTOR, INC. ALL RIGHTS RESERVED. | MECHANICAL OUTLINE | PRINT VERSION NOT TO SCALE | |
| TITLE: NI-780 | DOCUMENT NO: 98ASB15607C | | REV: G |
| | CASE NUMBER: 465-06 | | 31 MAR 2005 |
| | STANDARD: NON-JEDEC | | |

NOTES:

1. DIMENSIONING AND TOLERANCING PER ANSI Y14.5M-1994.
2. CONTROLLING DIMENSION: INCH.
3. DELETED
4. DIMENSION H IS MEASURED .030 (.762) AWAY FROM PACKAGE BODY.

STYLE 1:

- PIN
1. DRAIN
 2. GATE
 3. SOURCE

| DIM | INCH | | MILLIMETER | | DIM | INCH | | MILLIMETER | |
|---|-----------|-------|--------------------|-------|--------------------------|----------------------------|------|-------------|-------|
| | MIN | MAX | MIN | MAX | | MIN | MAX | MIN | MAX |
| A | 1.335 | 1.345 | 33.91 | 34.16 | R | .365 | .375 | 9.27 | 9.53 |
| B | .380 | .390 | 9.65 | 9.91 | S | .365 | .375 | 9.27 | 9.52 |
| C | .125 | .170 | 3.18 | 4.32 | aaa | — | .005 | — | 0.127 |
| D | .495 | .505 | 12.57 | 12.83 | bbb | — | .010 | — | 0.254 |
| E | .035 | .045 | 0.89 | 1.14 | ccc | — | .015 | — | 0.381 |
| F | .003 | .006 | 0.08 | 0.15 | — | — | — | — | — |
| G | 1.100 BSC | | 27.94 BSC | | — | — | — | — | — |
| H | .057 | .067 | 1.45 | 1.7 | — | — | — | — | — |
| K | .170 | .210 | 4.32 | 5.33 | — | — | — | — | — |
| M | .774 | .786 | 19.66 | 19.96 | — | — | — | — | — |
| N | .772 | .788 | 19.6 | 20 | — | — | — | — | — |
| Q | ∅.118 | ∅.138 | ∅3 | ∅3.51 | — | — | — | — | — |
| © FREESCALE SEMICONDUCTOR, INC. ALL RIGHTS RESERVED. | | | MECHANICAL OUTLINE | | | PRINT VERSION NOT TO SCALE | | | |
| TITLE: NI-780 | | | | | DOCUMENT NO: 98ASB15607C | | | REV: G | |
| | | | | | CASE NUMBER: 465-06 | | | 31 MAR 2005 | |
| | | | | | STANDARD: NON-JEDEC | | | | |

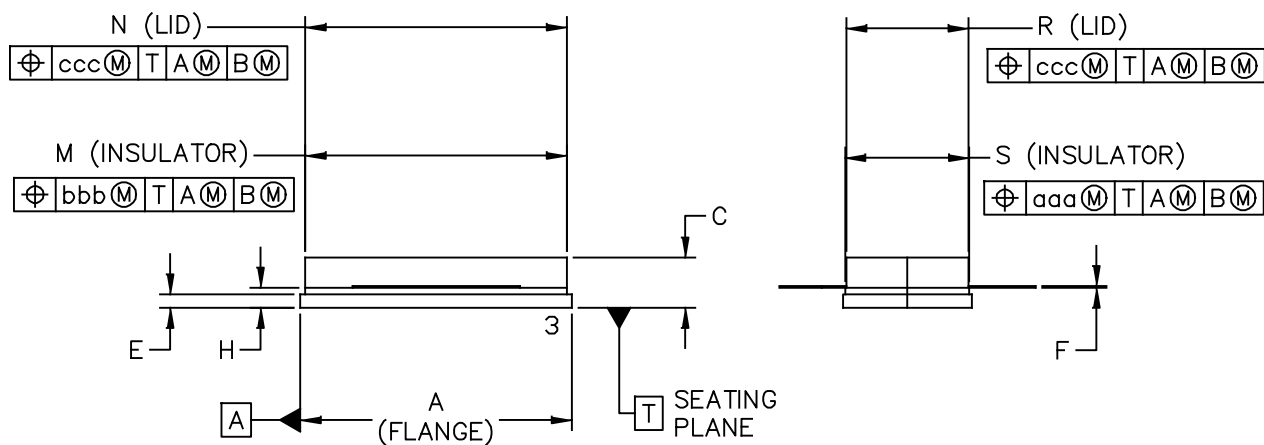
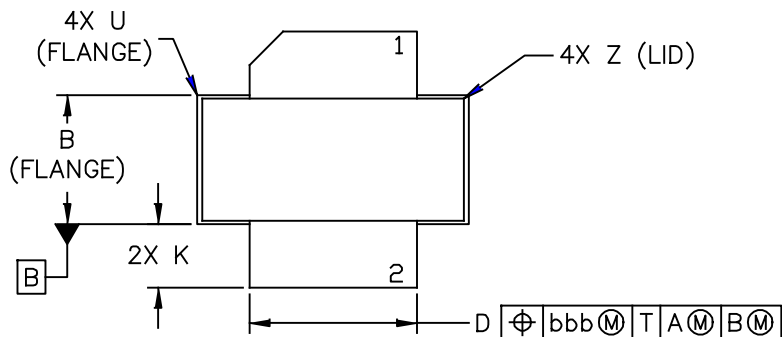

| | | | | | |
|---|--|--------------------------|--|----------------------------|--|
| © FREESCALE SEMICONDUCTOR, INC. ALL RIGHTS RESERVED. | | MECHANICAL OUTLINE | | PRINT VERSION NOT TO SCALE | |
| TITLE: NI-780S | | DOCUMENT NO: 98ASB16718C | | REV: H | |
| | | CASE NUMBER: 465A-06 | | 31 MAR 2005 | |
| | | STANDARD: NON-JEDEC | | | |

NOTES:

1. DIMENSIONING AND TOLERANCING PER ANSI Y14.5M-1994.
2. CONTROLLING DIMENSION: INCH.
3. DELETED
4. DIMENSION H IS MEASURED .030 (0.762) AWAY FROM PACKAGE BODY.

STYLE 1:

- PIN 1. DRAIN
2. GATE
3. SOURCE

| DIM | INCH | | MILLIMETER | | DIM | INCH | | MILLIMETER | |
|-----|------|-------|------------|-------|-----|-------|-------|------------|-----|
| | MIN | MAX | MIN | MAX | | MIN | MAX | MIN | MAX |
| A | .805 | -.815 | 20.45 | 20.7 | U | -.040 | 1.02 | | |
| B | .380 | -.390 | 9.65 | 9.91 | Z | -.030 | 0.76 | | |
| C | .125 | -.170 | 3.18 | 4.32 | aaa | -.005 | 0.127 | | |
| D | .495 | -.505 | 12.57 | 12.83 | bbb | -.010 | 0.254 | | |
| E | .035 | -.045 | 0.89 | 1.14 | ccc | -.015 | 0.381 | | |
| F | .003 | -.006 | 0.08 | 0.15 | - | - | - | | |
| H | .057 | -.067 | 1.45 | 1.7 | - | - | - | | |
| K | .170 | -.210 | 4.32 | 5.33 | - | - | - | | |
| M | .774 | -.786 | 19.61 | 20.02 | - | - | - | | |
| N | .772 | -.788 | 19.61 | 20.02 | - | - | - | | |
| R | .365 | -.375 | 9.27 | 9.53 | - | - | - | | |
| S | .365 | -.375 | 9.27 | 9.52 | - | - | - | | |

| | | | | | |
|---|--|--------------------------|--|----------------------------|--|
| © FREESCALE SEMICONDUCTOR, INC. ALL RIGHTS RESERVED. | | MECHANICAL OUTLINE | | PRINT VERSION NOT TO SCALE | |
| TITLE: NI-780S | | DOCUMENT NO: 98ASB16718C | | REV: H | |
| | | CASE NUMBER: 465A-06 | | 31 MAR 2005 | |
| | | STANDARD: NON-JEDEC | | | |

PRODUCT DOCUMENTATION

Refer to the following documents to aid your design process.

Application Notes

- AN1955: Thermal Measurement Methodology of RF Power Amplifiers

Engineering Bulletins

- EB212: Using Data Sheet Impedances for RF LDMOS Devices

REVISION HISTORY

The following table summarizes revisions to this document.

| Revision | Date | Description |
|----------|-----------|---------------------------------|
| 0 | Jan. 2014 | • Initial Release of Data Sheet |

How to Reach Us:

Home Page:
freescale.com

Web Support:
freescale.com/support

Information in this document is provided solely to enable system and software implementers to use Freescale products. There are no express or implied copyright licenses granted hereunder to design or fabricate any integrated circuits based on the information in this document.

Freescale reserves the right to make changes without further notice to any products herein. Freescale makes no warranty, representation, or guarantee regarding the suitability of its products for any particular purpose, nor does Freescale assume any liability arising out of the application or use of any product or circuit, and specifically disclaims any and all liability, including without limitation consequential or incidental damages. "Typical" parameters that may be provided in Freescale data sheets and/or specifications can and do vary in different applications, and actual performance may vary over time. All operating parameters, including "typicals," must be validated for each customer application by customer's technical experts. Freescale does not convey any license under its patent rights nor the rights of others. Freescale sells products pursuant to standard terms and conditions of sale, which can be found at the following address: freescale.com/SalesTermsandConditions.

Freescale and the Freescale logo are trademarks of Freescale Semiconductor, Inc., Reg. U.S. Pat. & Tm. Off. All other product or service names are the property of their respective owners.

© 2014 Freescale Semiconductor, Inc.



Компания «ЭлектроПласт» предлагает заключение долгосрочных отношений при поставках импортных электронных компонентов на взаимовыгодных условиях!

Наши преимущества:

- Оперативные поставки широкого спектра электронных компонентов отечественного и импортного производства напрямую от производителей и с крупнейших мировых складов;
- Поставка более 17-ти миллионов наименований электронных компонентов;
- Поставка сложных, дефицитных, либо снятых с производства позиций;
- Оперативные сроки поставки под заказ (от 5 рабочих дней);
- Экспресс доставка в любую точку России;
- Техническая поддержка проекта, помощь в подборе аналогов, поставка прототипов;
- Система менеджмента качества сертифицирована по Международному стандарту ISO 9001;
- Лицензия ФСБ на осуществление работ с использованием сведений, составляющих государственную тайну;
- Поставка специализированных компонентов (Xilinx, Altera, Analog Devices, Intersil, Interpoint, Microsemi, Aeroflex, Peregrine, Syfer, Eurofarad, Texas Instrument, Miteq, Cobham, E2V, MA-COM, Hittite, Mini-Circuits, General Dynamics и др.);

Помимо этого, одним из направлений компании «ЭлектроПласт» является направление «Источники питания». Мы предлагаем Вам помощь Конструкторского отдела:

- Подбор оптимального решения, техническое обоснование при выборе компонента;
- Подбор аналогов;
- Консультации по применению компонента;
- Поставка образцов и прототипов;
- Техническая поддержка проекта;
- Защита от снятия компонента с производства.



Как с нами связаться

Телефон: 8 (812) 309 58 32 (многоканальный)

Факс: 8 (812) 320-02-42

Электронная почта: org@eplast1.ru

Адрес: 198099, г. Санкт-Петербург, ул. Калинина, дом 2, корпус 4, литера А.