



Is Now Part of



ON Semiconductor®

To learn more about ON Semiconductor, please visit our website at
www.onsemi.com

Please note: As part of the Fairchild Semiconductor integration, some of the Fairchild orderable part numbers will need to change in order to meet ON Semiconductor's system requirements. Since the ON Semiconductor product management systems do not have the ability to manage part nomenclature that utilizes an underscore (_), the underscore (_) in the Fairchild part numbers will be changed to a dash (-). This document may contain device numbers with an underscore (_). Please check the ON Semiconductor website to verify the updated device numbers. The most current and up-to-date ordering information can be found at www.onsemi.com. Please email any questions regarding the system integration to Fairchild_questions@onsemi.com.

ON Semiconductor and the ON Semiconductor logo are trademarks of Semiconductor Components Industries, LLC dba ON Semiconductor or its subsidiaries in the United States and/or other countries. ON Semiconductor owns the rights to a number of patents, trademarks, copyrights, trade secrets, and other intellectual property. A listing of ON Semiconductor's product/patent coverage may be accessed at www.onsemi.com/site/pdf/Patent-Marking.pdf. ON Semiconductor reserves the right to make changes without further notice to any products herein. ON Semiconductor makes no warranty, representation or guarantee regarding the suitability of its products for any particular purpose, nor does ON Semiconductor assume any liability arising out of the application or use of any product or circuit, and specifically disclaims any and all liability, including without limitation special, consequential or incidental damages. Buyer is responsible for its products and applications using ON Semiconductor products, including compliance with all laws, regulations and safety requirements or standards, regardless of any support or applications information provided by ON Semiconductor. "Typical" parameters which may be provided in ON Semiconductor data sheets and/or specifications can and do vary in different applications and actual performance may vary over time. All operating parameters, including "Typicals" must be validated for each customer application by customer's technical experts. ON Semiconductor does not convey any license under its patent rights nor the rights of others. ON Semiconductor products are not designed, intended, or authorized for use as a critical component in life support systems or any FDA Class 3 medical devices or medical devices with a same or similar classification in a foreign jurisdiction or any devices intended for implantation in the human body. Should Buyer purchase or use ON Semiconductor products for any such unintended or unauthorized application, Buyer shall indemnify and hold ON Semiconductor and its officers, employees, subsidiaries, affiliates, and distributors harmless against all claims, costs, damages, and expenses, and reasonable attorney fees arising out of, directly or indirectly, any claim of personal injury or death associated with such unintended or unauthorized use, even if such claim alleges that ON Semiconductor was negligent regarding the design or manufacture of the part. ON Semiconductor is an Equal Opportunity/Affirmative Action Employer. This literature is subject to all applicable copyright laws and is not for resale in any manner.



August 2015

MOC3031M, MOC3032M, MOC3033M, MOC3041M, MOC3042M, MOC3043M 6-Pin DIP Zero-Cross Triac Driver Output Optocoupler (250/400 Volt Peak)

Features

- Simplifies Logic Control of 115 VAC Power
- Zero Voltage Crossing
- dv/dt of 2000 V/ μ s Typical, 1000 V/ μ s Guaranteed
- Peak Blocking Voltage
 - 250 V, MOC303XM
 - 400 V, MOC304XM
- Safety and Regulatory Approvals
 - UL1577, 4,170 VAC_{RMS} for 1 Minute
 - DIN EN/IEC60747-5-5

Applications

- Solenoid/Valve Controls
- Lighting Controls
- Static Power Switches
- AC Motor Drives
- Temperature Controls
- E.M. Contactors
- AC Motor Starters
- Solid State Relays

Description

The MOC303XM and MOC304XM devices consist of a GaAs infrared emitting diode optically coupled to a monolithic silicon detector performing the function of a zero voltage crossing bilateral triac driver.

They are designed for use with a triac in the interface of logic systems to equipment powered from 115 VAC lines, such as teletypewriters, CRTs, solid-state relays, industrial controls, printers, motors, solenoids and consumer appliances, etc.

Schematic



Figure 1. Schematic

Package Outlines

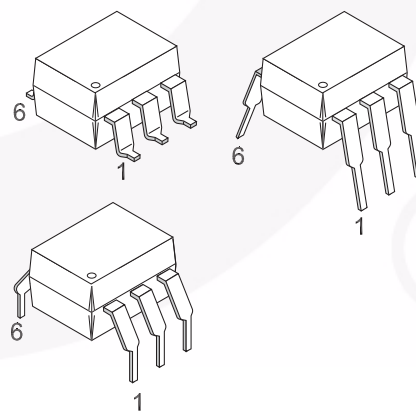

Figure 2. Package Outlines

MOC303XM, MOC304XM — 6-Pin DIP Zero-Cross Triac Driver Output Optocoupler (250/400 Volt Peak)

Safety and Insulation Ratings

As per DIN EN/IEC 60747-5-5, this optocoupler is suitable for "safe electrical insulation" only within the safety limit data. Compliance with the safety ratings shall be ensured by means of protective circuits.

| Parameter | | Characteristics |
|---|------------------------|-----------------|
| Installation Classifications per DIN VDE 0110/1.89 Table 1, For Rated Mains Voltage | < 150 V _{RMS} | I-IV |
| | < 300 V _{RMS} | I-IV |
| Climatic Classification | | 40/85/21 |
| Pollution Degree (DIN VDE 0110/1.89) | | 2 |
| Comparative Tracking Index | | 175 |

| Symbol | Parameter | Value | Unit |
|-------------------|--|-------------------|-------------------|
| V _{PR} | Input-to-Output Test Voltage, Method A, V _{IORM} × 1.6 = V _{PR} , Type and Sample Test with t _m = 10 s, Partial Discharge < 5 pC | 1275 | V _{peak} |
| | Input-to-Output Test Voltage, Method B, V _{IORM} × 1.875 = V _{PR} , 100% Production Test with t _m = 1 s, Partial Discharge < 5 pC | 1594 | V _{peak} |
| V _{IORM} | Maximum Working Insulation Voltage | 850 | V _{peak} |
| V _{IOTM} | Highest Allowable Over-Voltage | 6000 | V _{peak} |
| | External Creepage | ≥ 7 | mm |
| | External Clearance | ≥ 7 | mm |
| | External Clearance (for Option TV, 0.4" Lead Spacing) | ≥ 10 | mm |
| DTI | Distance Through Insulation (Insulation Thickness) | ≥ 0.5 | mm |
| R _{IO} | Insulation Resistance at T _S , V _{IO} = 500 V | > 10 ⁹ | Ω |

Absolute Maximum Ratings

Stresses exceeding the absolute maximum ratings may damage the device. The device may not function or be operable above the recommended operating conditions and stressing the parts to these levels is not recommended. In addition, extended exposure to stresses above the recommended operating conditions may affect device reliability. The absolute maximum ratings are stress ratings only. $T_A = 25^\circ\text{C}$ unless otherwise specified.

| Symbol | Parameters | Device | Value | Unit |
|---------------------|---|----------------------------------|-----------------------|----------------------|
| TOTAL DEVICE | | | | |
| T_{STG} | Storage Temperature | All | -40 to +150 | $^\circ\text{C}$ |
| T_{OPR} | Operating Temperature | All | -40 to +85 | $^\circ\text{C}$ |
| T_J | Junction Temperature Range | All | -40 to +100 | $^\circ\text{C}$ |
| T_{SOL} | Lead Solder Temperature | All | 260 for 10 seconds | $^\circ\text{C}$ |
| P_D | Total Device Power Dissipation at 25°C Ambient | All | 250 | mW |
| | Derate Above 25°C | | 2.94 | mW/ $^\circ\text{C}$ |
| EMITTER | | | | |
| I_F | Continuous Forward Current | All | 60 | mA |
| V_R | Reverse Voltage | All | 6 | V |
| P_D | Total Power Dissipation at 25°C Ambient | All | 120 | mW |
| | Derate Above 25°C | | 1.41 | mW/ $^\circ\text{C}$ |
| DETECTOR | | | | |
| V_{DRM} | Off-State Output Terminal Voltage | MOC3031M MOC3032M MOC3033M | 250 | V |
| | | MOC3041M MOC3042M MOC3043M | 400 | |
| I_{TSM} | Peak Repetitive Surge Current (PW = 100 μs , 120 pps) | All | 1 | A |
| P_D | Total Power Dissipation at 25°C Ambient | All | 150 | mW |
| | Derate Above 25°C | | 1.76 | mW/ $^\circ\text{C}$ |

Electrical Characteristics

$T_A = 25^\circ\text{C}$ unless otherwise specified.

Individual Component Characteristics

| Symbol | Parameters | Test Conditions | Device | Min. | Typ. | Max. | Unit |
|-------------------|--|--|--------|------|------|------|------------------|
| EMITTER | | | | | | | |
| V_F | Input Forward Voltage | $I_F = 30\text{ mA}$ | All | | 1.25 | 1.50 | V |
| I_R | Reverse Leakage Current | $V_R = 6\text{ V}$ | All | | 0.01 | 100 | μA |
| DETECTOR | | | | | | | |
| I_{DRM1} | Peak Blocking Current, Either Direction | Rated V_{DRM} , $I_F = 0^{(1)}$ | All | | | 100 | nA |
| V_{TM} | Peak On-State Voltage, Either Direction | $I_{\text{TM}} = 100\text{ mA peak}$, $I_F = 0$ | All | | 1.8 | 3.0 | V |
| dv/dt | Critical Rate of Rise of Off-State Voltage | $I_F = 0$ (Figure 11) ⁽²⁾ | All | 1000 | 2000 | | V/ μs |

Transfer Characteristics

| Symbol | DC Characteristics | Test Conditions | Device | Min. | Typ. | Max. | Unit |
|-----------------|-----------------------------------|--|----------|------|------|------|---------------|
| I_{FT} | LED Trigger Current | Main Terminal Voltage = $3\text{ V}^{(3)}$ | MOC3031M | | | 15 | mA |
| | | | MOC3041M | | | | |
| | | | MOC3032M | | | 10 | |
| | | | MOC3042M | | | | |
| I_{H} | Holding Current, Either Direction | | MOC3033M | | | 5 | μA |
| | | | MOC3043M | | | | |
| | | | All | | 400 | | μA |

Zero Crossing Characteristics

| Symbol | Characteristics | Test Conditions | Device | Min. | Typ. | Max. | Unit |
|-------------------|----------------------------|---|--------|------|------|------|------|
| V_{IH} | Inhibit Voltage | $I_F = \text{rated } I_{\text{FT}}$, MT1-MT2 voltage above which device will not trigger off-state | All | | | 20 | V |
| I_{DRM2} | Leakage in Inhibited State | $I_F = \text{rated } I_{\text{FT}}$, rated V_{DRM} off-state | All | | | 2 | mA |

Isolation Characteristics

| Symbol | Parameter | Test Conditions | Device | Min. | Typ. | Max. | Unit |
|------------------|----------------------------------|-----------------------|--------|------|------|------|--------------------|
| V_{ISO} | Isolation Voltage ⁽⁴⁾ | $t = 1\text{ Minute}$ | All | 4170 | | | V_{ACRMS} |

Notes:

- Test voltage must be applied within dv/dt rating.
- This is static dv/dt. See Figure 11 for test circuit. Commutating dv/dt is a function of the load-driving thyristor(s) only.
- All devices are guaranteed to trigger at an I_F value less than or equal to max I_{FT} . Therefore, recommended operating I_F lies between max I_{FT} (15 mA for MOC3031M and MOC3041M, 10 mA for MOC3032M and MOC3042M, 5 mA for MOC3033M and MOC3043M) and absolute maximum I_F (60 mA).
- Isolation voltage, V_{ISO} , is an internal device dielectric breakdown rating. For this test, pins 1 and 2 are common, and pins 4, 5 and 6 are common.

Typical Performance Curves



Figure 3. LED Forward Voltage vs. Forward Current



Figure 4. On-State Characteristics



Figure 5. Trigger Current vs. Temperature



Figure 6. Leakage Current, I_{DRM} vs. Temperature

Typical Performance Curves (Continued)



Figure 7. I_{DRM2} - Leakage in Inhibit State vs. Temperature



Figure 8. LED Current Required to Trigger vs. LED Pulse Width



Figure 9. Holding Current, I_H vs. Temperature



Figure 10. Inhibit Voltage vs. Temperature



Figure 11. Static dv/dt Test Circuit

1. The mercury wetted relay provides a high speed repeated pulse to the D.U.T.
2. 100x scope probes are used, to allow high speeds and voltages.
3. The worst-case condition for static dv/dt is established by triggering the D.U.T. with a normal LED input current, then removing the current. The variable R_{TEST} allows the dv/dt to be gradually increased until the D.U.T. continues to trigger in response to the applied voltage pulse, even after the LED current has been removed. The dv/dt is then decreased until the D.U.T stops triggering. τ_{RC} is measured at this point and recorded.



Figure 12. Static dv/dt Test Waveform (MOC3031M, MOC3032M, MOC3033M)



Figure 13. Static dv/dt Test Waveform (MOC3041M, MOC3042M, MOC3043M)

Typical circuit (Fig 14, 15) for use when hot line switching is required. In this circuit the “hot” side of the line is switched and the load connected to the cold or neutral side. The load may be connected to either the neutral or hot line.

R_{in} is calculated so that I_F is equal to the rated I_{FT} of the part, 5mA for the MOC3033M and MOC3043M, 10mA for the MOC3032M and MOC3042M, or 15mA for the MOC3031M and MOC3041M. The 39 ohm resistor and 0.01 μ F capacitor are for snubbing of the triac and may or may not be necessary depending upon the particular triac and load used.



*For highly inductive loads (power factor < 0.5), change this value to 360 ohms.

Figure 14. Hot-Line Switching Application Circuit (MOC3031M, MOC3032M, MOC3033M)



*For highly inductive loads (power factor < 0.5), change this value to 360 ohms.

Figure 15. Hot-Line Switching Application Circuit (MOC3041M, MOC3042M, MOC3043M)



**Figure 16. Inverse-Parallel SCR Driver Circuit
(MOC3031M, MOC3032M, MOC3033M)**

Suggested method of firing two, back-to-back SCR's with a Fairchild triac driver. Diodes can be 1N4001; resistors, R1 and R2, are optional 1k Ω .



**Figure 17. Inverse-Parallel SCR Driver Circuit
(MOC3041M, MOC3042M, MOC3043M)**

Suggested method of firing two, back-to-back SCR's with a Fairchild triac driver. Diodes can be 1N4001; resistors, R1 and R2, are optional 330 Ω .

Note:

This optoisolator should not be used to drive a load directly. It is intended to be a trigger device only.

Reflow Profile



Figure 18. Reflow Profile

Ordering Information⁽⁵⁾

| Part Number | Package | Packing Method |
|--------------|--|----------------------------|
| MOC3031M | DIP 6-Pin | Tube (50 Units) |
| MOC3031SM | SMT 6-Pin (Lead Bend) | Tube (50 Units) |
| MOC3031SR2M | SMT 6-Pin (Lead Bend) | Tape and Reel (1000 Units) |
| MOC3031VM | DIP 6-Pin, DIN EN/IEC60747-5-5 Option | Tube (50 Units) |
| MOC3031SVM | SMT 6-Pin (Lead Bend), DIN EN/IEC60747-5-5 Option | Tube (50 Units) |
| MOC3031SR2VM | SMT 6-Pin (Lead Bend), DIN EN/IEC60747-5-5 Option | Tape and Reel (1000 Units) |
| MOC3031TVM | DIP 6-Pin, 0.4" Lead Spacing, DIN EN/IEC60747-5-5 Option | Tube (50 Units) |

Note:

5. The product orderable part number system listed in this table also applies to the MOC3032M, MOC3033M, MOC3041M, MOC3042M, and MOC3043M product families.

Marking Information



Figure 19. Top Mark

| Top Mark Definitions | |
|----------------------|---|
| 1 | Fairchild Logo |
| 2 | Device Number |
| 3 | DIN EN/IEC60747-5-5 Option (only appears on component ordered with this option) |
| 4 | One-Digit Year Code, e.g., '5' |
| 5 | Two-Digit Work Week, Ranging from '01' to '53' |
| 6 | Assembly Package Code |



NOTES:

- A) NO STANDARD APPLIES TO THIS PACKAGE.
- B) ALL DIMENSIONS ARE IN MILLIMETERS.
- C) DIMENSIONS ARE EXCLUSIVE OF BURRS, MOLD FLASH, AND TIE BAR EXTRUSION
- D) DRAWING FILENAME AND REVISION: MKT-N06BREV4.





LAND PATTERN RECOMMENDATION



NOTES:

- A) NO STANDARD APPLIES TO THIS PACKAGE.
- B) ALL DIMENSIONS ARE IN MILLIMETERS.
- C) DIMENSIONS ARE EXCLUSIVE OF BURRS, MOLD FLASH, AND TIE BAR EXTRUSION
- D) DRAWING FILENAME AND REVISION : MKT-N06CREV4.





NOTES:

- A) NO STANDARD APPLIES TO THIS PACKAGE.
- B) ALL DIMENSIONS ARE IN MILLIMETERS.
- C) DIMENSIONS ARE EXCLUSIVE OF BURRS, MOLD FLASH, AND TIE BAR EXTRUSION
- D) DRAWING FILENAME AND REVISION: MKT-N06Drev4



ON Semiconductor and  are trademarks of Semiconductor Components Industries, LLC dba ON Semiconductor or its subsidiaries in the United States and/or other countries. ON Semiconductor owns the rights to a number of patents, trademarks, copyrights, trade secrets, and other intellectual property. A listing of ON Semiconductor's product/patent coverage may be accessed at www.onsemi.com/site/pdf/Patent-Marking.pdf. ON Semiconductor reserves the right to make changes without further notice to any products herein. ON Semiconductor makes no warranty, representation or guarantee regarding the suitability of its products for any particular purpose, nor does ON Semiconductor assume any liability arising out of the application or use of any product or circuit, and specifically disclaims any and all liability, including without limitation special, consequential or incidental damages. Buyer is responsible for its products and applications using ON Semiconductor products, including compliance with all laws, regulations and safety requirements or standards, regardless of any support or applications information provided by ON Semiconductor. "Typical" parameters which may be provided in ON Semiconductor data sheets and/or specifications can and do vary in different applications and actual performance may vary over time. All operating parameters, including "Typicals" must be validated for each customer application by customer's technical experts. ON Semiconductor does not convey any license under its patent rights nor the rights of others. ON Semiconductor products are not designed, intended, or authorized for use as a critical component in life support systems or any FDA Class 3 medical devices or medical devices with a same or similar classification in a foreign jurisdiction or any devices intended for implantation in the human body. Should Buyer purchase or use ON Semiconductor products for any such unintended or unauthorized application, Buyer shall indemnify and hold ON Semiconductor and its officers, employees, subsidiaries, affiliates, and distributors harmless against all claims, costs, damages, and expenses, and reasonable attorney fees arising out of, directly or indirectly, any claim of personal injury or death associated with such unintended or unauthorized use, even if such claim alleges that ON Semiconductor was negligent regarding the design or manufacture of the part. ON Semiconductor is an Equal Opportunity/Affirmative Action Employer. This literature is subject to all applicable copyright laws and is not for resale in any manner.

PUBLICATION ORDERING INFORMATION

LITERATURE FULFILLMENT:

Literature Distribution Center for ON Semiconductor
19521 E. 32nd Pkwy, Aurora, Colorado 80011 USA
Phone: 303-675-2175 or 800-344-3860 Toll Free USA/Canada
Fax: 303-675-2176 or 800-344-3867 Toll Free USA/Canada
Email: orderlit@onsemi.com

N. American Technical Support: 800-282-9855 Toll Free
USA/Canada
Europe, Middle East and Africa Technical Support:
Phone: 421 33 790 2910
Japan Customer Focus Center
Phone: 81-3-5817-1050

ON Semiconductor Website: www.onsemi.com
Order Literature: <http://www.onsemi.com/orderlit>
For additional information, please contact your local
Sales Representative

Mouser Electronics

Authorized Distributor

Click to View Pricing, Inventory, Delivery & Lifecycle Information:

[ON Semiconductor:](#)

[MOC3041SVM](#) [MOC3041TVM](#) [MOC3041SM](#) [MOC3041M](#) [MOC3041VM](#) [MOC3041SR2VM](#) [MOC3041SR2M](#)



Компания «ЭлектроПласт» предлагает заключение долгосрочных отношений при поставках импортных электронных компонентов на взаимовыгодных условиях!

Наши преимущества:

- Оперативные поставки широкого спектра электронных компонентов отечественного и импортного производства напрямую от производителей и с крупнейших мировых складов;
- Поставка более 17-ти миллионов наименований электронных компонентов;
- Поставка сложных, дефицитных, либо снятых с производства позиций;
- Оперативные сроки поставки под заказ (от 5 рабочих дней);
- Экспресс доставка в любую точку России;
- Техническая поддержка проекта, помощь в подборе аналогов, поставка прототипов;
- Система менеджмента качества сертифицирована по Международному стандарту ISO 9001;
- Лицензия ФСБ на осуществление работ с использованием сведений, составляющих государственную тайну;
- Поставка специализированных компонентов (Xilinx, Altera, Analog Devices, Intersil, Interpoint, Microsemi, Aeroflex, Peregrine, Syfer, Eurofarad, Texas Instrument, Miteq, Cobham, E2V, MA-COM, Hittite, Mini-Circuits, General Dynamics и др.);

Помимо этого, одним из направлений компании «ЭлектроПласт» является направление «Источники питания». Мы предлагаем Вам помощь Конструкторского отдела:

- Подбор оптимального решения, техническое обоснование при выборе компонента;
- Подбор аналогов;
- Консультации по применению компонента;
- Поставка образцов и прототипов;
- Техническая поддержка проекта;
- Защита от снятия компонента с производства.



Как с нами связаться

Телефон: 8 (812) 309 58 32 (многоканальный)

Факс: 8 (812) 320-02-42

Электронная почта: org@eplast1.ru

Адрес: 198099, г. Санкт-Петербург, ул. Калинина, дом 2, корпус 4, литера А.