

3M™ IDC Ribbon Cable Socket

.100" × .100" for .050" Pitch Cable

891 Series



- Preassembled, packaging on swords for easy loading of manual and semi-automatic assembly equipment
- “Bumps” are designed to prevent premature latch locking during shipment
- Optional double-sided adhesive pull tab for easy unplugging
- Double-recessed cover for cable terminating from either side virtually eliminating the need for single-recessed cover connectors
- Military polarization, with or without centerbump
- See the Regulatory Information Appendix (RIA) in the “RoHS compliance” section of www.3Mconnectors.com for compliance information (RIA E1 & C1 apply)

Date Modified: July 18, 2012

TS-0449-L
Sheet 1 of 3

Insulation:

Material: Glass Filled Polyester (PBT)

Flammability: UL 94V-0

Color: Gray

Contact:

Material: Phosphor Bronze

Plating:

Underplating: 50 μ" [1.27 μm] Nickel

Wiping Area: 30 μ" [0.76 μm] Gold

Wire Accommodation: 26 and 28 AWG Stranded

Marking: 3M Logo and Orientation Triangle

Current Rating:	1 line	6 Adjacent Lines	All Lines
	28 AWG	4.25	1.75
26 AWG	4.50	2.25	1.50

Rating Conditions: EIA-364-070 Method 2, 30°C maximum temperature rise, 20% derated. Reference appropriate 3M Product Specification for detailed current derating curves.

Insulation Resistance: $> 1 \times 10^9 \Omega$ at 500 V_{DC}

Withstanding Voltage: 1,000 V_{RMS} at Sea Level

Temperature Rating: -55°C to +105°C

UL File No.: E68080

3M™ IDC Ribbon Cable Socket

.100" × .100" for .050" Pitch Cable

891 Series



Contact Quantity	Dimensions	
	A	B
8	0.58 [14.7]	0.43 [10.9]
10	0.68 [17.3]	0.53 [13.5]
14	0.88 [22.4]	0.73 [18.5]
16	0.98 [24.9]	0.83 [21.1]
20	1.18 [30.0]	1.03 [26.2]
24	1.38 [35.1]	1.23 [31.2]
26	1.48 [37.6]	1.33 [33.8]
30	1.68 [42.7]	1.53 [38.9]
34	1.88 [47.8]	1.73 [43.9]
36	1.98 [50.3]	1.83 [46.5]
40	2.18 [55.4]	2.03 [51.6]
44	2.38 [60.5]	2.23 [56.4]
50	2.68 [68.1]	2.53 [64.3]
60	3.18 [80.8]	3.03 [77.0]

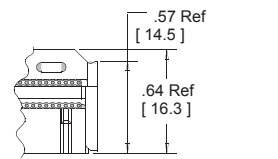
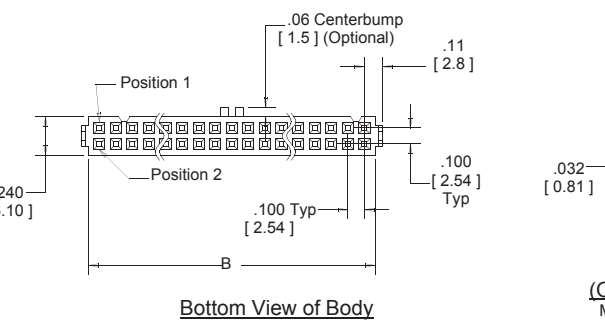
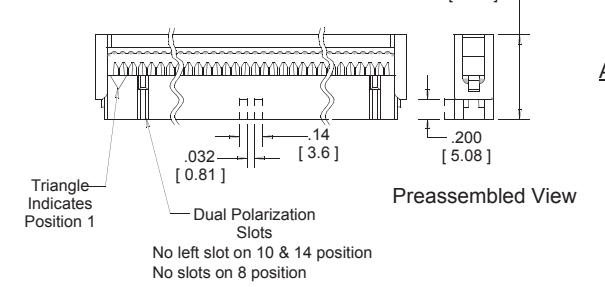
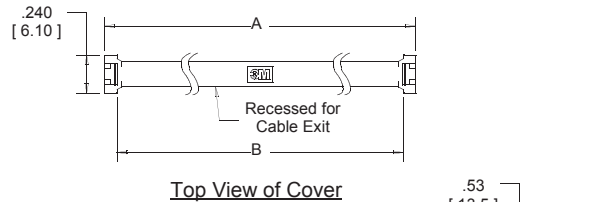
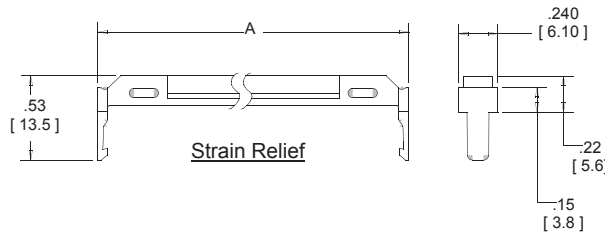

Assembled Height with Standard Plastic Strain Relief

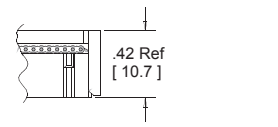

Assembled Height Without Strain Relief

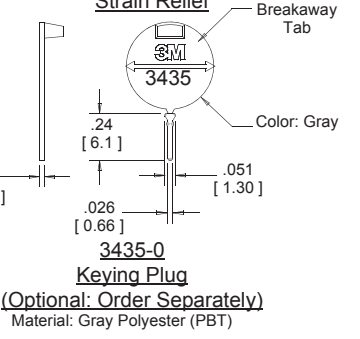

Inch (mm)

Tolerance Unless Noted			
	.0	.00	.000
Inch	±.1	±.01	±.005

[] Dimensions for Reference only

Ordering Information

Sockets
891XX-0X0X

Contact Quantity See Table

1 = No Strain Relief
 3 = Strain Relief

Package Style Options:
 0 = Preassembled

Polarization Options:
 0 = Without Centerbump
 1 = With Centerbump

Strain Relief
 (Order Separately)
3448-891XX

Contact Quantity:
 See Table

Pull Tabs
 (Order Separately)
 See TS-0496

Assembly tools: 3M™ Press (or equivalent) 3640, 3M™ Locator Plate 3443-107N, 3M™ Platen 3442-9.

3M™ IDC Ribbon Cable Socket

.100" × .100" for .050" Pitch Cable

891 Series



Recommended Post Pattern for Stacked Configurations

Note 1: Measured at tip.

Note 2: Tapered pin tip configuration recommended.

TS-0449-L
Sheet 3 of 3

Important Notice

All statements, technical information, and recommendations related to 3M's products are based on information believed to be reliable, but the accuracy or completeness is not guaranteed. Before using this product, you must evaluate it and determine if it is suitable for your intended application. You assume all risks and liability associated with such use. Any statements related to the product which are not contained in 3M's current publications, or any contrary statements contained on your purchase order shall have no force or effect unless expressly agreed upon, in writing, by an authorized officer of 3M.

Warranty; Limited Remedy; Limited Liability.

This product will be free from defects in material and manufacture for a period of one (1) year from the time of purchase. **3M MAKES NO OTHER WARRANTIES INCLUDING, BUT NOT LIMITED TO, ANY IMPLIED WARRANTY OF MERCHANTABILITY OR FITNESS FOR A PARTICULAR PURPOSE.** If this product is defective within the warranty period stated above, your exclusive remedy shall be, at 3M's option, to replace or repair the 3M product or refund the purchase price of the 3M product. **Except where prohibited by law, 3M will not be liable for any indirect, special, incidental or consequential loss or damage arising from this 3M product, regardless of the legal theory asserted.**

**3M Electronics Solutions Division**

6801 River Place Blvd.
Austin, TX 78726-9000
U.S.A.
1-800-225-5373
www.3Mconnectors.com

Please recycle. Printed in USA.
© 3M 2012. All rights reserved.
RIA-2217B-E

3M is a trademark of 3M Company.



Компания «ЭлектроПласт» предлагает заключение долгосрочных отношений при поставках импортных электронных компонентов на взаимовыгодных условиях!

Наши преимущества:

- Оперативные поставки широкого спектра электронных компонентов отечественного и импортного производства напрямую от производителей и с крупнейших мировых складов;
- Поставка более 17-ти миллионов наименований электронных компонентов;
- Поставка сложных, дефицитных, либо снятых с производства позиций;
- Оперативные сроки поставки под заказ (от 5 рабочих дней);
- Экспресс доставка в любую точку России;
- Техническая поддержка проекта, помощь в подборе аналогов, поставка прототипов;
- Система менеджмента качества сертифицирована по Международному стандарту ISO 9001;
- Лицензия ФСБ на осуществление работ с использованием сведений, составляющих государственную тайну;
- Поставка специализированных компонентов (Xilinx, Altera, Analog Devices, Intersil, Interpoint, Microsemi, Aeroflex, Peregrine, Syfer, Eurofarad, Texas Instrument, Miteq, Cobham, E2V, MA-COM, Hittite, Mini-Circuits, General Dynamics и др.);

Помимо этого, одним из направлений компании «ЭлектроПласт» является направление «Источники питания». Мы предлагаем Вам помощь Конструкторского отдела:

- Подбор оптимального решения, техническое обоснование при выборе компонента;
- Подбор аналогов;
- Консультации по применению компонента;
- Поставка образцов и прототипов;
- Техническая поддержка проекта;
- Защита от снятия компонента с производства.



Как с нами связаться

Телефон: 8 (812) 309 58 32 (многоканальный)

Факс: 8 (812) 320-02-42

Электронная почта: org@eplast1.ru

Адрес: 198099, г. Санкт-Петербург, ул. Калинина, дом 2, корпус 4, литера А.